

DOCUMENTATION

AIRSPRAY GUN

FPro P

Manual : 582.097.110-UK - 1711

Date: 23/11/17

Supersede : 06/11/17

Modif.:

TRANSLATION FROM THE ORIGINAL MANUAL

IMPORTANT : Before assembly and start-up, please read and clearly understand all the documents relating to this equipment (professional use only).

THE PICTURES AND DRAWINGS ARE NON CONTRACTUAL. WE RESERVE THE RIGHT TO MAKE CHANGES WITHOUT PRIOR NOTICE..

SAMES KREMLIN SAS
13, chemin de Malacher
38 240 - MEYLAN - France
 : 33 (0)4 76 41 60 60

www.sames-kremlin.com



<p style="text-align: center;">FR</p> <p><u>Pour une utilisation sûre, il est de votre responsabilité de :</u></p> <ul style="list-style-type: none"> • Lire attentivement tous les documents contenus dans le CD joint avant la mise en service de l'équipement, • D'installer, d'utiliser, d'entretenir et de réparer l'équipement conformément aux préconisations de SAMES KREMLIN ainsi qu'aux réglementations nationales et/ou locales, • Vous assurez que les utilisateurs de cet équipement ont été formés, ont parfaitement compris les règles de sécurité et qu'ils les appliquent. 	<p style="text-align: center;">UK</p> <p><u>To ensure safe use of the machinery, it is your responsibility to:</u></p> <ul style="list-style-type: none"> • Carefully read all documents contained on the enclosed CD before putting the machinery into service, • Install, use, maintain and repair the machinery in accordance with SAMES KREMLIN's recommendations and national and/or local regulations, • Make sure that the users of the machinery have received proper training and that they have perfectly understood the safety rules and apply them. 	<p style="text-align: center;">DE</p> <p><u>Eine sichere Nutzung setzt voraus, dass Sie: :</u></p> <ul style="list-style-type: none"> • alle in der CD enthaltenen Dokumente vor der Inbetriebnahme der Anlage aufmerksam lesen, • die Anlage im Einklang mit den Empfehlungen von SAMES KREMLIN sowie mit den nationalen und/oder lokalen Bestimmungen installieren, verwenden, warten und reparieren, • sich vergewissern, dass die Nutzer dieser Anlage angemessen geschult wurden, die Sicherheitsbestimmungen verstanden haben und sie anwenden.
<p style="text-align: center;">ES</p> <p><u>Para una utilización segura, será de su responsabilidad:</u></p> <ul style="list-style-type: none"> • leer atentamente todos los documentos que se incluyen en el CD adjunto antes de la puesta en servicio del equipo, • instalar, utilizar, efectuar el mantenimiento y reparar el equipo con arreglo a las recomendaciones de SAMES KREMLIN y a la normativa nacional y/o local, • cerciorarse de que los usuarios de este equipo han recibido la formación necesaria, han entendido perfectamente las normas de seguridad y las aplican. 	<p style="text-align: center;">IT</p> <p><u>Per un uso sicuro, vi invitiamo a:</u></p> <ul style="list-style-type: none"> • leggere attentamente tutta la documentazione contenuta nel CD allegato prima della messa in funzione dell'apparecchio, • installare, utilizzare, mantenere e riparare l'apparecchio rispettando le raccomandazioni di SAMES KREMLIN, nonché le normative nazionali e/o locali, • accertarvi che gli utilizzatori dell'apparecchio abbiano ricevuto adeguata formazione, abbiano perfettamente compreso le regole di sicurezza e le applichino. 	<p style="text-align: center;">PT</p> <p><u>Para uma utilização segura, é da sua responsabilidade:</u></p> <ul style="list-style-type: none"> • Ler atentamente todos os documentos incluídos no CD em anexo antes de pôr o equipamento em funcionamento, • Proceder à instalação, utilização, manutenção e reparação do equipamento de acordo com as preconizações de SAMES KREMLIN, bem como com outros regulamentos nacionais e/ou locais aplicáveis, • Assegurar-se que os utilizadores do equipamento foram devidamente capacitados, compreenderam perfeitamente e aplicam as devidas regras de segurança.
<p style="text-align: center;">NL</p> <p><u>Voor een veilig gebruik dient u:</u></p> <ul style="list-style-type: none"> • alle document op de bijgevoegde cd aandachtig te lezen alvorens het apparaat in werking te stellen, • het apparaat te installeren, gebruiken, onderhouden en repareren volgens de door SAMES KREMLIN gegeven aanbevelingen en overeenkomstig de nationale en/of plaatselijke reglementeringen, • zeker te stellen dat de gebruikers van dit apparaat zijn opgeleid, de veiligheidsregels perfect hebben begrepen en dat zij die ook toepassen. 	<p style="text-align: center;">SE</p> <p><u>För en säker användning av utrustningen ansvarar ni för följande:</u></p> <ul style="list-style-type: none"> • Läs noga samtliga dokument som finns på den medföljande cd-skivan innan utrustningen tas i drift. • Installera, använd, underhåll och reparera utrustningen enligt anvisningarna från SAMES KREMLIN och enligt nationella och/eller lokala bestämmelser. • Försäkra er om att användare av denna utrustning erhållit utbildning, till fullo förstått säkerhetsföreskrifterna och tillämpar dem. 	<p style="text-align: center;">FI</p> <p><u>Käytön turvallisuuden varmistamiseksi velvollisuutesi on:</u></p> <ul style="list-style-type: none"> • Lukea huolella kaikki CD:llä olevat asiakirjat ennen laitteiston käyttöönottoa, • Noudataa laitteiston asennuksessa, käytössä, kunnossapidossa ja huollossa SAMES KREMLIN in suosituksia sekä kansallisia ja/tai paikallisia määräyksiä, • Varmistaa, että laitteiston käyttäjät ovat koulutettuja ja ymmärtävät täysin turvallisuusmääräykset ja miten niitä sovelletaan.
<p style="text-align: center;">PL</p> <p><u>Dla zapewnienia bezpiecznego użytkowania na użytkownika spoczywa obowiązek:</u></p> <ul style="list-style-type: none"> • Uważnego zapoznania się ze wszystkimi dokumentami znajdującymi się na załączonej płycie CD przed pierwszym uruchomieniem urządzenia, • Instalowania, użytkowania, konserwacji i naprawy urządzenia zgodnie z zaleceniami firmy SAMES KREMLIN oraz z przepisami miejscowymi, • Upewnienia, że wszyscy przeszkoleni użytkownicy urządzenia zrozumieli zasady bezpieczeństwa i stosują się do nich. 	<p style="text-align: center;">CS</p> <p><u>Pro bezpečné používání jste povinni:</u></p> <ul style="list-style-type: none"> • Před uvedením zařízení do provozu si pozorně přečt' veškeré dokumenty obsažené na přiloženém CD, • Nainstalovat, používat, udržívat a opravovat zařízení v souladu s pokyny firmy SAMES KREMLIN a s národními a/nebo místními legislativními předpisy, • Ujistit se, že uživatelé tohoto zařízení byli vyškoleni, že dokonale pochopili bezpečnostní pravidla a že je dodrží. 	<p style="text-align: center;">SL</p> <p><u>Za varno uporabo ste dolžni:</u></p> <ul style="list-style-type: none"> • natančno prebrati vse dokumente na CD pred zagonom stroja, • instalirati, uporabljati, vzdrževati in popravljati opremo po določilih SAMES KREMLIN in v skladu z veljavnimi nacionalnimi in/ali lokalnimi predpisi, • poskrbeti, da so uporabniki te opreme ustrezno usposobljeni, poznajo varnostne predpise in da jih upoštevajo.
<p style="text-align: center;">SK</p> <p><u>V záujme bezpečného je vašou povinnosťou:</u></p> <ul style="list-style-type: none"> • pozorne si prečítať všetky dokumenty obsiahnuté na priloženom CD predtým, ako zariadenie uvediete do prevádzky, • nainštalovať, používať, udržiavať a opravovať zariadenie v súlade s odporúčaniami spoločnosti SAMES KREMLIN a národnými a/alebo miestnymi predpismi, • uistiť sa, že používatelia tohto zariadenia boli zaškolení, riadne porozumeli pravidlám bezpečnosti a používajú ich. 	<p style="text-align: center;">HU</p> <p><u>A biztonságos használat érdekében az Ön felelőssége, hogy:</u></p> <ul style="list-style-type: none"> • a berendezés üzembe helyezésé előtt figyelmesen elolvassa a mellékelt CD által tartalmazott összes dokumentumot, • a berendezést a SAMES KREMLIN ajánlásainak valamint a nemzeti és/vagy helyi szabályozásoknak megfelelően helyezze üzembe, használja, tartsa karban és javítsa, • megbizonyosodjon róla, hogy a berendezés felhasználói képzettek, tökéletesen megértették és alkalmazzák a biztonsági előírásokat. 	<p style="text-align: center;">RO</p> <p><u>Pentru o utilizare sigură, este responsabilitatea dvs. să:</u></p> <ul style="list-style-type: none"> • Citiți cu atenție toate documentele de pe CD-ul anexat, înainte de punerea în funcțiune a echipamentului, • Instalați, utilizați, întrețineți și reparați echipamentul conform instrucțiunilor SAMES KREMLIN precum și reglementărilor naționale și/sau locale, • Vă asigurați că utilizatorii acestui echipament au fost instruiți, au înțeles perfect regulile de securitate și le aplică integral.

Déclaration(s) de conformité au verso de ce document / Declaration(s) of conformity at the back of this document / Konformitätserklärung(en) auf der Rückseite dieser Unterlage / Declaración (es) de conformidad en el reverso de este documento / Dichiarazione/i di conformità sul retro del presente documento / Declaração(ões) de conformidade no verso do documento / Conformiteitsverklaring(en) op de keerzijde van dit document / Försäkran om överensstämmelse på omstående sida av detta dokument / Vaatimustenmukaisuusvakuutukset tämän asiakirjan kääntöpuolella / Deklaracja(e) zgodności na odwrocie dokumentu / Prohlášení o shodě se nachází/nacházejí na zadní straně tohoto dokumentu / Deklaracija(e) o skladnosti na hrbni strani tega dokumenta / Vyhlášení/-a o zhode sa nachádzajú na zadnej strane dokumentu / A dokumentum hátlapján szereplő megfelelőségi nyilatkoz(ok) / Declarații de conformitate pe versoul acestui document



DECLARATION UE DE CONFORMITE
EU DECLARATION OF CONFORMITY
EU-KONFORMITÄTSEKTLÄRUNG
DECLARACIÓN UE DE CONFORMIDAD
DICHIARAZIONE DI CONFORMITÀ UE
DECLARAÇÃO UE DE CONFORMIDADE
EU-CONFORMITEITSVERKLARING
EU-FÖRSÄKRAN OM ÖVERENSSTÄMMELSE
EU-VAAITIMUKSEN MUKAISUUSVAKUUTUS
DEKLARACJA ZGODNOŚCI UE
EU PROHLÁŠENÍ O SHODĚ
IZJAVA EU O SKLADNOSTI
VYHLÁŠENIE O ZHODE
EU-MEGFELELŐSÉGI NYILATKOZAT
DECLARAȚIA DE CONFORMITATE UE

Le fabricant / The manufacturer / Der Hersteller / El fabricante / Il produttore / O fabricante / De fabrikant / Tillverkare / Valmistaja / Producent / Výrobce / Proizvajalec / Výrobca / Gyártó / Fabricantul:	SAMES KREMLIN SAS 13, chemin de Malacher 38 240 - MEYLAN - FRANCE Tél. : 33 (0)4 76 41 60 60
---	--

Déclare que le matériel désigné ci-après / Herewith declares that the equipment / erklart hiermit, dass die / Declara que el material designado a continuación / Dichiaro che il materiale sottoindicato / Declara que o material a seguir designado / verklaart dat de hieronder aangeduide apparatuur / Kungör att den utrustning som anges här nedan / ilmoittaa, että alla mainitut laitteistot / Oświadczam, że wymienione poniżej urządzenia / Prohlašuje, že níže uvedené vybavení / Izjavljam, da je opisana oprema spodaj / Vyhlasuje, že zariadenie uvedené nižšie / Kijelenti, hogy a megjelölt anyag a továbbiakban / Declară că echipamentul precizat mai jos:

PISTOLETS MANUELS DE PULVERISATION PNEUMATIQUES / AIRSPRAY MANUAL SPRAYING GUNS
/ LUFTZERSTÄUBENDE HAND-SPRITPISTOLEN / PISTOLAS MANUALES DE PULVERIZACIÓN NEUMÁTICAS

FPRO LOCK P LP
FPRO LOCK P CONV
FPRO P LP
FPRO P CONV

Est conforme à la législation d'harmonisation de l'Union applicable suivante / Is in conformity with the relevant Union harmonisation legislation / Erfüllt die einschlägigen Harmonisierungsrechtsvorschriften der Union / es conforme con la legislación de armonización pertinente de la Unión / è conforme alla pertinente normativa di armonizzazione dell'Unione / in overeenstemming met de desbetreffende harmonisatiewetgeving van de Unie / med den relevanta harmoniserade unionslagstiftningen / on asiaa koskevan unionin yhdenmukaistamislainsäädännön vaatimusten mukainen / jest zgodny z odpowiednimi wymaganiami unijnego prawodawstwa harmonizacyjnego / Shoduje se s následující příslušnou evropskou harmonizační legislativou / V skladu s harmonizirano zakonodajno Unije / Je v súlade s uplatniteľnými harmonizačnými právnymi predpismi EÚ / Megfelel a következő alkalmazandó uniós harmonizációs szabályozásnak / Este conform cu legislația aplicabilă de armonizare de mai jos

Directive ATEX / ATEX Directive / ATEX Richtlinie / Directiva ATEX / Direttiva ATEX / Diretiva ATEX / ATEX-Richtlijn / ATEX-direktivet / ATEX-direktivi / Dyrektywa ATEX / Směrnice ATEX / Direktiva ATEX / Smernica ATEX / ATEX-irányelv	
 II 2G Ex h IIA T6 X Gb	
Procédure d'évaluation de la conformité : Module A Documentation technique (Annexe VIII) archivée par : / Conformity assessment procedure: Module A Technical documentation (ANNEX VIII) recorded by: / Verfahren zur Konformitätsbewertung: Modul A Technische Unterlagen (ANLAGE VIII) archiviert durch: / Procedimiento de evaluación de la conformidad: Módulo A Documentación técnica (ANEXO VIII) archivada por: / Procedura di valutazione della conformità: Modulo A Documentazione tecnica (ALLEGATO VIII) archiviata a cura di: / Procedimento de avaliação da conformidade: Módulo A Documentação técnica (ANEXO VIII) arquivada por: / Conformiteitsbeoordelingsprocedure: Module A Technische documentatie (BIJLAGE VIII) gearhiveerd door: / Förfarande för bedömning av överensstämmelse: Modul A Teknisk dokumentation (BILAGA VIII) arkiverad av: / Vaatimustenmukaisuusarviointimenetelmä: moduuli A Tekninen dokumentaatio (LIITE VIII) arkistoitu: / Procedura oceny zgodności: Modul A Dokumentacja technicznej (ZAŁĄCZNIK VIII) zarchiwizowane przez: / Postup posuzování shody: Modul A Technická dokumentace (PŘÍLOHA VIII) archivována: / Postopek preverjanja skladnosti: Modul A Tehnična dokumentacija (PRILOGA VIII), arhiviral: / Postup posudzovania zhody: Modul A Technická dokumentácia (PRÍLOHA VIII) archivovaná prostredníctvom: / Megfelelősgértékelési eljárás: A. modul Műszaki dokumentáció (VIII. MELLÉKLET) archiválta: / Procedura de evaluare a conformității: Modulul A Documentația tehnică (ANEXA VIII) este arhivată de:	2014/34/UE
INERIS 0080 - 60550 Verneuil-en-Halatte - France	

La présente déclaration de conformité est établie sous la seule responsabilité du fabricant / This declaration of conformity is issued under the sole responsibility of the manufacturer / Die alleinige Verantwortung für die Ausstellung dieser Konformitätserklärung trägt der Hersteller / La presente declaración de conformidad se expide bajo la exclusiva responsabilidad del fabricante / La presente dichiarazione di conformità è rilasciata sotto la responsabilità esclusiva del fabbricante / A presente declaração de conformidade é emitida sob a exclusiva responsabilidade do fabricante / Deze conformiteitsverklaring wordt verstrekt onder volledige verantwoordelijkheid van de fabrikant / Denna försäkran om överensstämmelse utfärdas på tillverkarens eget ansvar / Tämä vaatimustenmukaisuusvakuutus on annettu valmistajan yksinomaisella vastuulla / Niniejsza deklaracja zgodności wydana zostaje na wyłączną odpowiedzialność producenta / Toto prohlášení o shodě se vydává na výhradní odpovědnost výrobce / Za izdajo te izjave o skladnosti je odgovoren izključno proizvajalec / Toto vyhlásenie o zhode sa vydáva / na vlastnú zodpovednosť výrobcu / Ezt a megfelelőségi nyilatkozatot a gyártó kizárólagos felelőssége mellett adják ti / Prezenta declarație de conformitate este emisă pe răspunderea exclusivă a producătorului.



Philippe PROVENAZ

Directeur Innovation & Développement / Innovation & Development
Director / Direktor für Innovation & Entwicklung / Director de
Inovación y Desarrollo / Direttore Innovazione e sviluppo
/ Diretor de Inovação / Manager Innovatie en Ontwikkeling / Direktör
för Forskning och Utveckling / Innovaatio- ja kehitysjohtaja
/ Dyrektor ds. Innowacji I Rozwoju / Ředitel pro inovace a vývoj
/ Direktor za inovacije in razvoj / Riaditel' pre inováciu a rozvoj
/ Innovációs és fejlesztési igazgató / Director Inovație și Dezvoltare

Fait à Meylan, le / Established in Meylan, on / Geschehen zu Meylan, am / En Meylan, a / Redatto a Meylan, / Vastgesteld te Meylan, / Utformat i
Meylan, den / Meylan, Ranska, / Sporządzono w Meylan, dnia / Meylan, dnia / V Meylanu, / V Meylan dňa / Kelt Meylanban, / Întocmită la Meylan,
pe data de 22/11/2017 - 11/22/2017



INSTALLATION AND SAFETY INSTRUCTIONS

TRANSLATION OF THE ORIGINAL MANUAL

IMPORTANT : Before assembly and start-up, please read and clearly understand all the documents relating to this equipment (professional use only).

THE PICTURES AND DRAWINGS ARE NON CONTRACTUAL. WE RESERVE THE RIGHT TO MAKE CHANGES WITHOUT PRIOR NOTICE.

KREMLIN - REXSON

150, avenue de Stalingrad

93 245 - STAINS CEDEX – France

☎ : 33 (0)1 49 40 25 25 *Fax* : 33 (0)1 48 26 07 16

www.kremlin-rexson.com

1. SAFETY INSTRUCTIONS

GENERAL SAFETY INSTRUCTIONS



CAUTION : The equipment can be dangerous if you do not follow our instructions concerning installation and servicing described in this manual and in accordance with applicable European standards and local national safety regulations.

Please carefully read all the instruction literature before operating your equipment.

Only trained operators can use the equipment (To acquire an essential training, please contact the "KREMLIN REXSON University" training center - Stains).

The foreman must ensure that the operator has understood the safety instructions for this equipment as well as the instructions in the manuals for the different parts and accessories.

Read carefully all instruction manuals, label markings before operating the equipment.



















Incorrect use may result in injury. This equipment is for professional use only. It must be used only for what it has been designed for. Never modify the equipment. The parts and accessories supplied must be regularly inspected. Defective or worn parts must be replaced.

Guards (motor cover, coupling shields, connectors,...) have been designed for a safe use of the equipment.
The manufacturer will not be held responsible for bodily injury or failure and / or property damage due to destruction, the overshadowing or the partial or total removal of the guards.

Never exceed the equipment components' maximum working pressure.

Comply with regulations concerning safety, fire risks, electrical regulations in force in the country of final destination of the material. Use only products or solvent compatible with the parts in contact with the material (refer to data sheet of the material manufacturer).

PICTOGRAMS

					
NIP HAZARD	WARNING MOVING ELEVATOR	WARNING MOVING PARTS	WARNING MOVING SHOVEL	DO NOT EXCEED THIS PRESSURE	HIGH PRESSURE HAZARD
					
RELIEF OR DRAIN VALVE	WARNING HOSE UNDER PRESSURE	WEAR GLASSES OBLIGATORY	WEAR OF GLOVES IS OBLIGATORY	PRODUCT VAPOR HAZARDS	WARNING HOT PARTS OR AREAS
					
ELECTRICAL HAZARD	WARNING FIRE HAZARDS	EXPLOSION HAZARDS	GROUNDING	WARNING (USER)	WARNING SERIOUS INJURIES

FIRE - EXPLOSION - SPARKS - STATIC ELECTRICITY HAZARDS

A poor earth connection, inadequate ventilation, sparks or static electricity can cause an explosion or fire. to avoid these risks when using or servicing KREMLIN REXSON equipment, the following safety procedures must be followed :



- ensure a good earth connection and ground the parts to be handled i.e. solvents, materials, components and equipment,
- ensure adequate ventilation,
- keep working area clean and free from waste solvents, chemicals, or solid waste i.e. rags, paper and empty chemicals drums,
- never use electrical switches / power if in an atmosphere of volatile solvent vapour,
- stop working immediately in case of electrical arcs,
- never store chemicals and solvents in the working area.
- use paint whose flash point is the highest possible to prevent from any formation of gas and inflammable vapours (refer to materials' safety instructions),
- install a cover on the drums to reduce the diffusion of gas and vapours in the spraybooth.

TOXIC PRODUCT HAZARDS

Toxic products or vapours can cause severe injury not only through contact with the body, but also if the products are ingested or inhaled. It is imperative :



- to know the material products and their risks,
- notified or hazardous materials must be stored in accordance with the regulations,
- the material must be stored in an appropriate container, never place materials in a container where there is a risk of spillage or leakage,
- a procedure must be applied for the safe disposal of waste material. It must comply with all prevailing regulations and legislations of the country where the equipment is to be used,
- protective clothing should always be worn in compliance with the material manufacturers' recommendations,
- depending on the application and chemical safety instructions, safety glasses, hearing protective earplug, gloves, foot wear, protective masks and possible breathing equipment should be worn to comply with the regulations (Refer to chapter "Safety equipment of KREMLIN selection guide).

CAUTION!

It is forbidden to use material containing high concentrations of halogenated hydrocarbon solvents with **aluminium or zinc fillers** .Non-compliance with the instructions may cause explosion risk causing serious or fatal injury.

EQUIPMENT REQUIREMENTS

Guards (motor cover, coupling shields, connectors,...) have been designed for a safe use of the equipment.

The manufacturer will not be held responsible for bodily injury or failure and / or property damage due to destruction, the overshadowing or the partial or total removal of the guards.

PUMP



Before carrying out any work, it is imperative to read and clearly understand the disassembly and reassembly instructions before servicing. The operator must understand the equipment and the safety instructions. These instructions are available in the equipment manuals.



The air motor is designed to be mounted with a pump. Never modify any components or couplings. When operating, please keep hands away from moving parts. Before starting up the equipment, please read the PRESSURE RELIEF instructions. Please ensure that any relief or drain valves fitted are in good working order.

HOSES

- Keep hoses out of circulation areas, moving parts or hot surfaces,
- Never expose product hoses to temperature higher than + 60°C / 140° F or lower than 0°C / 32° F,
- Never pull or use the hoses to move the equipment,
- Tighten all fittings as well as the hoses before operating the equipment,
- Check the hoses regularly; change them if they are damaged,
- Never exceed the working pressure (WP) indicated on the hose.

USED PRODUCTS

Considering the wide variety of products that are available and can be used in our equipment it is impossible to check and make recommendations for all chemical data, regarding the risks of possible chemical attack and their long term chemical reaction

KREMLIN REXSON can not be held liable for :

- Compatibility of wetted parts,
- Risks to staff and the surroundings,
- for worn or defective parts, for faulty equipment or units, or the quality of final product.

It is the responsibility of the user to know and prevent any possible risks such as toxic vapours, fires or explosions. He shall determine the risks of immediate reactions or pursuant to repeated exposures of the staff,

KREMLIN REXSON shall not be liable for physical injuries, direct or indirect material damages caused by the use of chemicals.

2. HANDLING



Check the weight and the dimensions of the equipment

(refer to 'Technical features' section of the instruction manual

If weight and dimensions are too important, the unloading must be carried out by means of a forklift or any other appropriate means with a qualified personnel and in a clear horizontal area to prevent from risks of damage injury or an accident.

The centre of gravity is not in the centre of the machine : carry out by hand a stability-test after having lifted the whole at 10 cm / 3.937" maximum.

After the unloading, the handling of the whole (eg: elevator pump) is carried out by means of a pallet truck taking the bottom part of the frame.

Remark : Each pump motor is fitted with a ring. The ring is designed for the hoisting of one pump and can not be used for the handling of the complete machine.

3. STORING

Storing before installation :

- Storing ambient temperature : 0 / +50 °C / 0 / +122°F
- Protect the whole against dust, water trickling, dampness and shocks.

Storing after installation :

- Operating temperature : +15 / +35 °C / +59 / +138.2° F
- Protect the whole against dust, water trickling, dampness and shocks.

4. INSTALLATION OF THE EQUIPMENT

The machine is installed on a stable horizontal floor (for eg a concrete flag).



To avoid risks caused by static electricity, the equipment as well as its components must be grounded.

- **For the pumping equipments** (pumps, pneumatic rams, frame...), a section wire of 2.5 mm² is fixed on the material. Use this wire to connect the material to "the general ground". In case of severe environments (mechanical protection of the wire of earthing insufficient, vibrations, mobile material...) where function damages at the ground are probable, the user have to replace the provided wire of 2.5 mm² by a device more adapted to its environment (wire with a more important section, bonding strip, fixing by thimble with eyelet...),

The continuity of the ground must be controlled by a qualified electrician. If the continuity of the ground is not ensured, check the terminal, the wire and the earthing point. **Never** use the material without have solved this problem.

- In the severe cases of environments (mechanical protection of the wire of earthing insufficient, vibrations, mobile material...) where damages of the function put at the ground are probable, the user will have to replace the wire of 2.5 mm² provided, by a device more adapted to its environment (wire of more important section, bonding strip, fixing by thimble with eyelet...),
- **The gun** must be 'grounded' via a material hose or an air hose. In case of spraying by means of a gun with cup, the air hose must be conductive,
- **The materials to be painted** must also be grounded.

All the materials situated in the working area shall be grounded.



- **Never store** more than necessary inflammable materials inside the working area,
- The materials must be stored into **approved drums** and grounded,
- Use only grounded **metals containers** for the use of cleaning solvents,
- **Cardboard and paper are prohibited.**

5. MARKING OF THE EQUIPMENT

Each equipment has a marking plate.

The plate consists of the name of the manufacturer, the equipment part number and important information for correct use of the equipment (air pressure, electric power,...).



AIRSPRAY GUN

FPro P

Disassembly / Reassembly

TRANSLATION FROM THE ORIGINAL MANUAL

IMPORTANT : Before assembly and start-up, please read and clearly understand all the documents relating to the equipment (professional use only).

THE PICTURES AND DRAWINGS ARE NOT CONTRACTUAL. WE RESERVE THE RIGHT TO MAKE CHANGES WITHOUT PRIOR NOTICE.

SAMES KREMLIN SAS
13, chemin de Malacher
38 240 - MEYLAN - France
☎ : 33 (0)4 76 41 60 60

www.sames-kremlin.com



CAUTION :

Before any intervention, shut off the compressed air supply and depressurize the circuits by triggering the gun. controlling the opening of the gun.

The gun is manufactured under the ATEX agreement and can not be modified. SAMES KREMLIN will not be held responsible for any failure to comply with that instruction.

Before removing a component of the gun, some precautions have to be taken :

- Shut off the pump main supply,
- Empty out the paint inside the cup or the receiver,
- Fill the cup or the receiver with cleaning solvent,
- Spray the solvent until it runs clear,
- Shut off the supply air pressure of the gun,
- Shut off the fluid pressure,
- Remove the part to be cleaned or changed.

Before reassembling the different components, some precautions must be taken :

- **Clean all the parts with the appropriate cleaning solvent and a brush.**
- **Install new seals if it is necessary after having lubricated them with PTFE grease.**
- **Install new parts if it is necessary.**

FPRO P LP - CONV

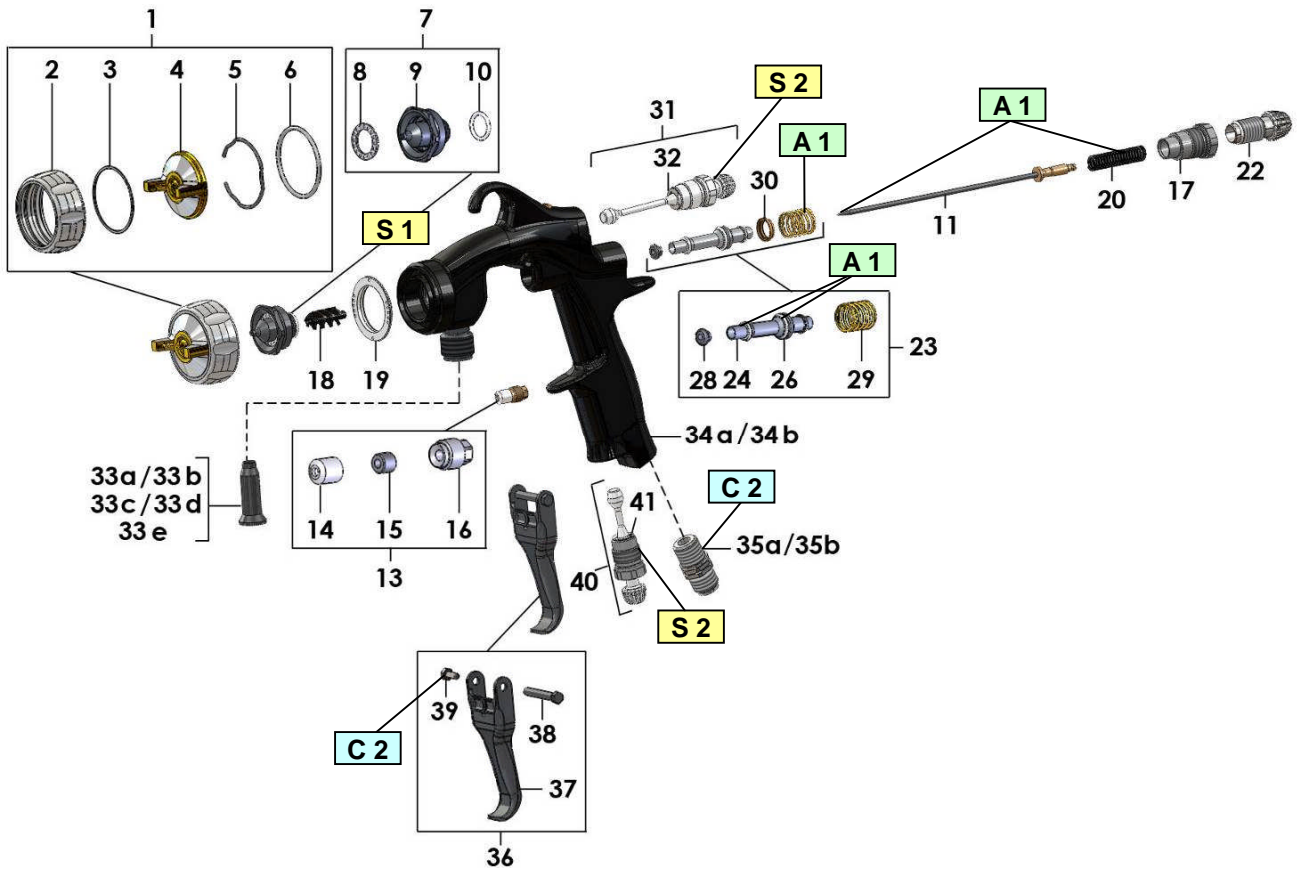

FPRO P LOCK LP - LOCK CONV

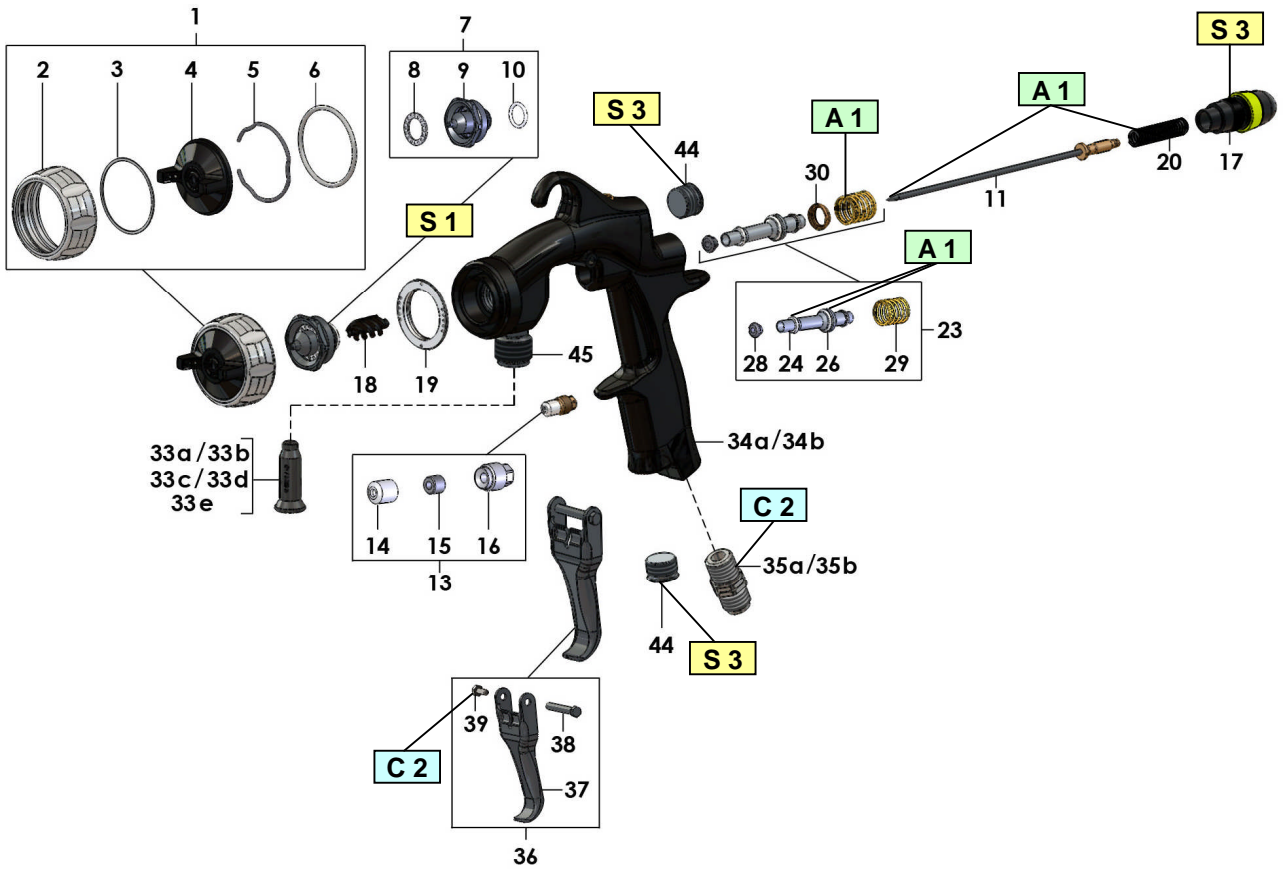

Index	Instructions	Description	Part number
A 1	PTFE grease	PTFE grease (10 ml / 0.0026 US gal)	560.440.101
C 2	Low strength - Anaerobic Adhesive	Loctite 222 (50 ml / 0.013 US gal)	554.180.010
S 1	Torque screwing : 18 Nm / 13.276 Ft/Lbs		
S 2	Torque screwing : 10 Nm / 7.376 Ft/Lbs		
S 3	Torque screwing : 5 Nm / 3.688 Ft/Lbs		

▪ **PROJECTOR (IND. 1 + 7 + 11) & VORTEX (IND. 18) REPLACEMENT**

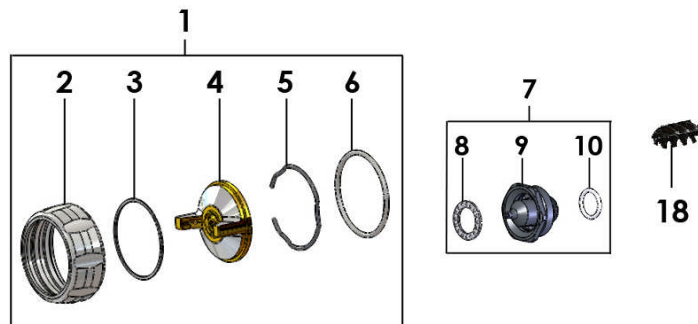

Unscrew the aircap assembly (1), then remove the aircap ring (2), the aircap only (4), the stop ring (5) and the ring seal (6).

Trigger the gun (36) then unscrew the nozzle assembly (7) with the wrench provided with the gun.

Remove the distribution ring (8) and the nozzle seal (10).

Remove the vortex (18) and the distribution ring (19).

For the guns, model FPRO P LP and CONV : unscrew the needle stop (22), then remove the needle spring (20) and the needle (11) by the rear part of the gun.

For the guns, model FPRO P LOCK LP and LOCK CONV : unscrew the needle stop sleeve (17), then remove the needle (11) by the rear part of the gun.

Check parts' conditions. Change them if necessary.

Lubricate the needle (11) and the needle spring (20) with grease.

For the guns, model FPRO P LP and CONV : reinstall them as well as the needle stop (22).

For the guns, model FPRO P LOCK LP and LOCK CONV : reinstall them as well as the needle stop sleeve (17) - screwing torque : 5 Nm / 3.688 Ft/Lbs.

Reinstall the distribution ring (19) and the vortex (18).

Reinstall the new nozzle assembly (7). Tighten it by means of the wrench - screwing torque : 18 Nm / 13.276 Ft/Lbs.

Reinstall the new aircap assembly (1).

NOTA : the gun can operate without vortex (18) if necessary.

▪ **NEEDLE PACKING (IND. 13) REPLACEMENT**

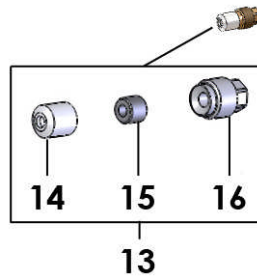

Make sure there is no more paint inside the gun.

For the guns, model FPRO P LP and CONV : unscrew the needle stop (22) and remove the needle spring (20).

For the guns, model FPRO P LOCK LP and LOCK CONV : unscrew the needle stop sleeve (17) and remove the needle spring (20).

Remove the needle (11) completely by the rear part of the gun.

Dismount the trigger (36) by removing the screw (39) and the trigger spindle (38) by means of two wrenches n° 5.5.

Unscrew the packing holder (16) by means of the wrench supplied with the gun.

Take off the needle packing (13) that consists of a seat (14) and a bearing (15).

Insert the bearing (15) into the seat (14) and replace the whole in the gun.

Screw the packing holder (16) moderately.

Reinstall the needle (11).

For the guns, model FPRO P LP and CONV : reinstall the lubricated needle spring (20) and the needle stop (22).

For the guns, model FPRO P LOCK LP and LOCK CONV : reinstall the lubricated needle spring (20) and the needle stop sleeve (17) - screwing torque : 5 Nm / 3.688 Ft/Lbs.

Tighten up the packing holder (16) by means of the wrench supplied with the gun and unscrew it by a 1/4 turn.

Remount the trigger (36).

Feed paint

If there is a leak, screw slightly.

▪ **AIR VALVE (IND. 23) REPLACEMENT**

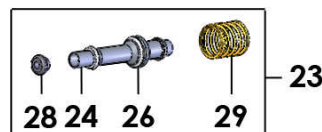

For the guns, model FPRO P LP and CONV : unscrew the needle stop (22), then remove the needle spring (20) and the needle (11) by the rear part of the gun.

For the guns, model FPRO P LOCK LP and LOCK CONV : unscrew the needle stop sleeve (17), then remove the needle spring (20) and the needle (11) by the rear part of the gun.

Trigger the gun (36) the unscrew the needle stop sleeve (17) by means of the wrench supplied with the gun.

Take off the valve spring (29) as well as the air valve body (24), the air valve stop (30) and the carrier (28).

Reinstall the carrier (28) on the new air valve body (24).

Install that new assembly, the air valve stop (30), the lubricated valve spring (29) into the gun body.

Screw the needle stop sleeve (17).

For the guns, model FPRO P LP and CONV : reinstall the needle (11), the lubricated needle spring (20) and the needle stop (22).

For the guns, model FPRO P LOCK LP and LOCK CONV : reinstall the needle (11), the lubricated needle spring (20) and the needle stop sleeve (17) - screwing torque : 5 Nm / 3.688 Ft/Lbs.

▪ **AIR VALVE SEAL (IND. 26) REPLACEMENT**

Take off the air valve (23) - refer to previous paragraph.

Remove the seal (26).

Lubricate the new seal (26) and place it in its housing.

➔ **CAUTION : When reassembling, carefully insert the air valve (24) into the gun body carrying out a rotary motion so as to preformate the valve seal (26).**

▪ **INJECTOR (IND. 33A/33B/33C/33D/33E) REPLACEMENT**

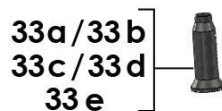

Unscrew the gun fluid hose.

Remove the injector (33a/33b/33c/33d/33e).

Check the injector condition and change it if necessary.

Reinstall the parts in the reverse order of the disassembly sequence.

NOTA : the gun can operate without injector (33a/33b/33c/33d/33e) if necessary.

▪ **TRIGGER (IND. 36) REPLACEMENT**

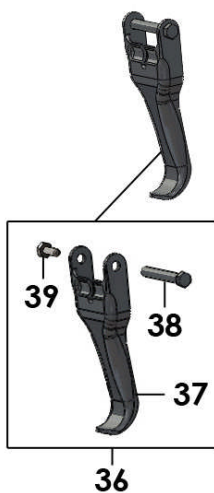

Unscrew the needle stop (22) and take off the needle spring (20).

Remove the needle (11) completely by the rear part of the gun.

Dismount the trigger (36) by removing the screw (39) and the trigger spindle (38) by means of two wrenches n° 5.5.

Reinstall the parts in the reverse order of the disassembly sequence. Apply previously low strength - Anaerobic adhesive on the screw (39).

- **AIR ADJUSTER ASSEMBLY (IND. 31 & IND. 40) (ONLY FOR FPRO P LP - CONV)**

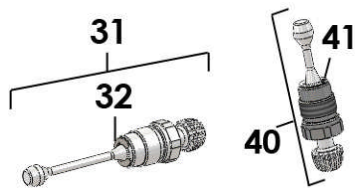

Unscrew the air adjuster (31 and/or 40) by means of the wrench supplied with the gun.

Check the ring (32 and/or 41) condition and change it if necessary.

Reinstall the new air adjuster (31 and/or 40) by means of the wrench supplied with the gun - screwing torque : 10 Nm // 7.376 Ft/Lbs.

- **SWIVEL FITTING (IND. 35A/35B) REPLACEMENT**

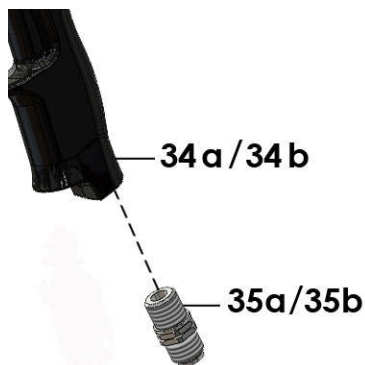

Unscrew the swivel fitting (35a/35b) from the gun (34a/34b) by means of the wrench supplied with the gun.

Install the new swivel fitting (35a/35b).

- **LOCKABLE AIR ADJUSTER ASSEMBLY (IND. 50) REPLACEMENT (ONLY FOR FPRO P LOCK LP - LOCK CONV)**



Unscrew the nut by means of the wrench supplied with the gun.

Unscrew the lockable air adjuster assembly (50) by means of an Allen wrench n° 4.

Reinstall the lockable air adjuster assembly (50) on the gun and screw by means of the Allen wrench n° 4 until getting the position.

Screw the nut by means of the wrench supplied with gun to tighten the position.

Doc. 573.495.050 Date/Datum/Fecha : 20/07/17 Annule/Cancel/ Ersetzt/Anula :	Modif. / Änderung :	Pièces de rechange Spare parts list Ersatzteilliste Piezas de repuesto
--	---------------------	---

FPRO P LP - CONV	PISTOLET PNEUMATIQUE / AIRSPRAY GUN PNEUMATISCHE PISTOLE / PISTOLA NEUMÁTICA
-----------------------------	---

F PRO P LP (HVLP)		F PRO P LP (LVLP)	
(☐)	#	(☐)	#
	135.770.000		135.770.000
+ HVLP-07-XLvb	135.777.507	+ LVLP-07-XLvb	135.770.507
+ HVLP-09-XLvb	135.777.509	+ LVLP-09-XLvb	135.770.509
+ HVLP-12-XLvb	135.777.512	+ LVLP-12-XLvb	135.770.512
+ HVLP-15-XLvb	135.777.515	+ LVLP-15-XLvb	135.770.515
+ HVLP-18-XLvb	135.777.518	+ LVLP-18-XLvb	135.770.518

F PRO P CONV	
(☐)	#
	135.774.000
+ CONV-07-Lvb	135.774.407
+ CONV-09-Lvb	135.774.409
+ CONV-12-Lvb	135.774.412
+ CONV-15-Lvb	135.774.415
+ CONV-18-Lvb	135.774.418
+ CONV-23-Lvb	135.774.423
+ CONV-27-Lvb	135.774.427

(☐) : pistolet sans projecteur / gun without projector / Pistole ohne Zerstäubereinheit / Pistola sin proyector

FPRO P LP	Standard / Estándar
------------------	----------------------------

Projecteur / Projector / Zerstäubereinheit / Proyector		Tête / Aircap Luftkappe / Cabezal		Buse / Nozzle Düse / Boquilla			Pointeau / Needle Nadel / Aguja	
Ind. 1+7+11	#	Ind. 1	#	Ind. 7	Ø (mm / ")	#	Ind. 11	#
HVLP-07-XLvb	131 777 507	HVLP -07 22 -XLvb	132 777 500	07	0,7 / 0.028	134 130 100	07- 09 -12	033 140 100
HVLP-09-XLvb	131 777 509			09	0,9 / 0.035	134 130 200		
HVLP-12-XLvb	131 777 512			12	1,2 / 0.047	134 130 300		
HVLP-15-XLvb	131 777 515			15	1,5 / 0.059	134 130 600	15 - 18	033 140 200
HVLP-18-XLvb	131 777 518			18	1,8 / 0.071	134 130 700		
LVLP-07-XLvb	131 770 507	LVLP -07 22 -XLvb	132 770 500	07	0,7 / 0.028	134 130 100	07- 09 -12	033 140 100
LVLP-09-XLvb	131 770 509			09	0,9 / 0.035	134 130 200		
LVLP-12-XLvb	131 770 512			12	1,2 / 0.047	134 130 300		
LVLP-15-XLvb	131 770 515			15	1,5 / 0.059	134 130 600	15 - 18	033 140 200
LVLP-18-XLvb	131 770 518			18	1,8 / 0.071	134 130 700		

FPRO P CONV	Standard / Estándar
--------------------	----------------------------

Projecteur / Projector / Zerstäubereinheit / Proyector		Tête / Aircap Luftkappe / Cabezal		Buse / Nozzle Düse / Boquilla			Pointeau / Needle Nadel / Aguja	
Ind. 1+7+11	#	Ind. 1	#	Ind. 7	Ø (mm / ")	#	Ind. 11	#
CONV-07-Lvb	131 774 407	CONV -07 22-Lvb	132 774 400	07	0,7 / 0.028	134 130 100	07 - 09 - 12	033 140 100
CONV-09-Lvb	131 774 409			09	0,9 / 0.035	134 130 200		
CONV-12-Lvb	131 774 412			12	1,2 / 0.047	134 130 300		
CONV-15-Lvb	131 774 415			15	1,5 / 0.059	134 130 600	15 - 18	033 140 200
CONV-18-Lvb	131 774 418			18	1,8 / 0.071	134 130 700		

FPRO P CONV	Produits épais / Thick paint / Dicker Lack / Pintura espesa
--------------------	--

Projecteur / Projector / Zerstäubereinheit / Proyector		Tête / Aircap Luftkappe / Cabezal		Buse / Nozzle Düse / Boquilla			Pointeau / Needle Nadel / Aguja	
Ind. 1+7+11	#	Ind. 1	#	Ind. 7	Ø (mm / ")	#	Ind. 11	#
CONV-23-Lvb	131 774 423	CONV -23 27-Lvb	132 774 450	23	2,3 / 0.09	134 131 100	23 - 27	033 140 300
CONV-27-Lvb	131 774 427			27	2,7 / 0.106	134 131 200		
CONV-33-Lvb	131 774 433	CONV -33 40-Lvb	132 774 460	33	3,3 / 0.13	134 131 300	33 - 40	033 140 400
CONV-40-Lvb	131 774 440			40	4 / 0.157	134 131 400		

FPRO P CONV	Produit chargé / HS paint / Gefüllte Produkte / Producto cargado
--------------------	---

Projecteur / Projector / Zerstäubereinheit / Proyector		Tête / Aircap Luftkappe / Cabezal		Buse / Nozzle Düse / Boquilla			Pointeau / Needle Nadel / Aguja	
Ind. 1+7+11	#	Ind. 1	#	Ind. 7	Ø (mm / ")	#	Ind. 11	#
CONV-23-Mvb	131 774 323	CONV -23 27-Mvb	132 774 350	23	2,3 / 0.09	134 131 100	23 - 27	033 140 300
CONV-27-Mvb	131 774 327			27	2,7 / 0.106	134 131 200		

FPRO P CONV	Jet rond tourbillonnaire / Swirling round fan / Rundwirbelstrahl / Abanico redondo turbulento
--------------------	--

Projecteur / Projector / Zerstäubereinheit / Proyector		Tête / Aircap / Luftkappe / Cabezal		Buse / Nozzle / Düse / Boquilla			Pointeau / Needle / Nadel / Aguja	
Ind. 1+7+11	#	Ind. 1	#	Ind. 7	Ø (mm / ")	#	Ind. 11	#
CONV-23-Srb	131 774 223	CONV -23 27-Srb	132 774 250	23	2,3 / 0.09	134 131 100	23 - 27	033 140 300
CONV-27-Srb	131 774 227			27	2,7 / 0.106	134 131 200		
CONV-33-Srb	131 774 233	CONV -33 40- Srb	132 774 260	33	3,3 / 0.13	134 131 300	33 - 40	033 140 400
CONV-40-Srb	131 774 240			40	4 / 0.157	134 131 400		

FPRO P CONV	Application colle / Glue application / Applikation von Kleber / Aplicación de colas
--------------------	--

Projecteur / Projector / Zerstäubereinheit / Proyector		Tête / Aircap / Luftkappe / Cabezal		Buse / Nozzle / Düse / Boquilla			Pointeau / Needle / Nadel / Aguja	
Ind. 1+7+11	#	Ind. 1	#	Ind. 7	Ø (mm / ")	#	Ind. 11	#
CONV-15-Mgb	131 774 315	CONV -15 18 -Mgb	132 774 370	15	1,5 / 0.059	134 131 500	15 - 18	033 140 200
CONV-18-Mgb	131 774 318			18	1,8 / 0.071	134 131 600		

FPRO P CONV	Produits abrasifs / Abrasive products / Abrasive Materialien / Productos abrasivos
--------------------	---

Projecteur / Projector / Zerstäubereinheit / Proyector		Tête / Aircap / Luftkappe / Cabezal		Buse / Nozzle / Düse / Boquilla			Pointeau / Needle / Nadel / Aguja	
Ind. 1+7+11	#	Ind. 1	#	Ind. 7	Ø (mm / ")	#	Ind. 11	#
CONV-07-Lwb	131 774 907	CONV -07 22-Lvb	132 774 400	07 T	0,7 / 0.028	134 135 100	07 - 23	033 148 100
CONV-09-Lwb	131 774 909			09 T	0,9 / 0.035	134 135 200		
CONV-12-Lwb	131 774 912			12 T	1,2 / 0.047	134 135 300		
CONV-15-Lwb	131 774 915			15 T	1,5 / 0.059	134 135 600		
CONV-18-Lwb	131 774 918			18 T	1,8 / 0.071	134 135 700		
CONV-23-Lwb	131 774 923	CONV -23 27-Lvb	132 774 450	23 T	2,3 / 0.09	134 136 100	07 - 23	033 148 100

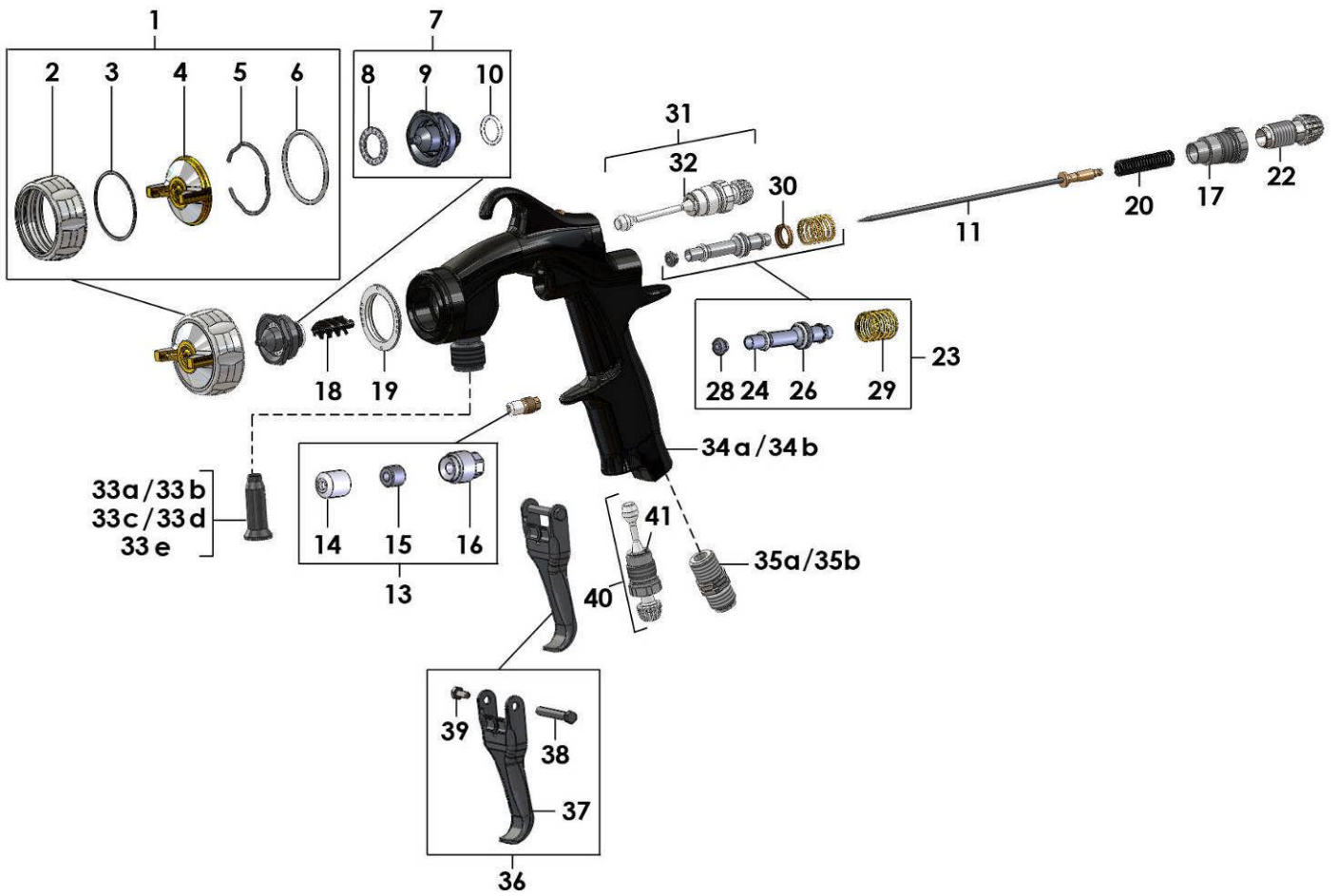

Pièces communes - Common parts - Gleiche Teile - Partes comunes

Ind	#	Désignation	Description	Bezeichnung	Denominación	Qté
*1	-	Tête complète (voir tableau)	Aircap assembly (refer to chart)	Luftkappe kpl. (siehe Tabelle)	Cabezal complet (consultar cuadro)	1
2	032 760 005	▪ Bague de tête	▪ Aircap ring	▪ Haltering	▪ Anillo del cabezal	1
3	129 080 007	▪ Joint de tête (x 2)	▪ Seal, aircap (x 2)	▪ O-Ring (2 St.)	▪ Junta de cabezal (x 2)	1
4	NC / NS	▪ Tête nue	▪ Aircap only	▪ Luftkappe	▪ Cabezal solo	1
5	NC / NS	▪ Anneau de retenue	▪ Stop ring	▪ Sicherungsring	▪ Anillo de retención	1
6	150 040 309	▪ Joint de bague (x 10)	▪ Seal, ring (x 10)	▪ O-Ring (10 St.)	▪ Junta del anillo (x 10)	1
*7	-	Buse équipée (voir tableau)	Nozzle assembly (refer to chart)	Düse kpl. (siehe Tabelle)	Boquilla equipada (consultar cuadro)	1
*8	129 130 004	▪ Bague de répartition (x 5)	▪ Distribution ring (x 5)	▪ Luftverteilerling (5 St.)	▪ Anillo de distribución (x 5)	1
9	NC / NS	▪ Buse	▪ Nozzle	▪ Düse	▪ Boquilla	1
10	129 209 902	▪ Joint de buse (x 5)	▪ Seal, nozzle (x 5)	▪ O-Ring, Düse (5 St.)	▪ Junta de boquilla (x 5)	1
*11	-	Pointeau (voir tableau)	Needle (refer to chart)	Farbnadel (siehe Tabelle)	Aguja (consultar cuadro)	1
13	129 130 903	Garniture pointeau (x 5)	Packing, needle (x 5)	Nadelgarnitur (5 St.)	Guarnición de aguja (x 5)	1
14	NC / NS	▪ Siège (x 5)	▪ Seat (x 5)	▪ Sitz (5 St.)	▪ Asiento (x 5)	1
15	NC / NS	▪ Palier (x 5)	▪ Bearing (x 5)	▪ Plastikeinsatz (5 St.)	▪ Palier (x 5)	1
16	029 130 006	▪ Presse-garniture (x 1)	▪ Packing holder (x 1)	▪ Packungsschraube (1 St.)	▪ Prensa-guarnición (x 1)	1
17	029 030 003	Fourreau	Sleeve, needle stop	Nadelführung	Manguito	1
18	129 140 031	Vortex (x 1)	Vortex (x 1)	Vortex (x 1)	Vortex (x 1)	1
19	129 130 003	Bague de répartition (x 5)	Distribution ring (x 5)	Luftverteilerling (5 St.)	Anillo de distribución (x 5)	1
*20	050 311 248	Ressort de pointeau	Spring, needle	Farbnadelfeder	Muelle de aguja	1
22	029 770 006	Butée de pointeau	Needle stop	Farbnadelanschlag	Tope de aguja	1
*23	129 030 020	Soupape d'air complète	Air valve assembly	Luftventil kpl.	Válvula de aire completa	1
24	NC / NS	▪ Corps de soupape	▪ Body, air valve	▪ Luftventilkörper	▪ Cuerpo de válvula	1
26	129 030 022	▪ Joint de soupape (x 10)	▪ Seal, air valve (x 10)	▪ Dichtung (10 St.)	▪ Junta de válvula (x 10)	1
*28	129 030 026	▪ Entraîneur (x 5)	▪ Carrier (x 5)	▪ Mitnehmer (5 St.)	▪ Arrastre (x 5)	1
*29	050 311 321	▪ Ressort de soupape	▪ Spring, valve	▪ Ventulfeder	▪ Muelle de válvula	1
30	129 140 008	Butée de soupape	Air valve stop	Luftventilanschlag	Tope de válvula	1
*31	129 130 020	Pointeau d'air (évents)	Air adjuster assembly	Spritzstrahlregulier- ventil	Aguja de aire (eventos)	1
32	NC / NS	▪ Circlips Ø 6	▪ Ring, model Ø 6	▪ Sicherungsring Ø 6	▪ Anillo truarc, tipo Ø 6	1

Ind	#	Désignation	Description	Bezeichnung	Denominación	Qté
33a	129 140 023	Injecteur 0,8 mm	Injector, model 0.8 mm / 0.031"	Injektor 0,8 mm	Inyector, tipo 0,8 mm	1
33b	129 140 024	Injecteur 0,9 mm	Injector, model 0.9 mm / 0.035"	Injektor 0,9 mm	Inyector, tipo 0,9 mm	1
33c	129 140 025	Injecteur 1,0 mm	Injector, model 1.0 mm / 0.039"	Injektor 1 mm	Inyector, tipo 1,0 mm	1
33d	129 140 026	Injecteur 1,2 mm	Injector, model 1.2 mm / 0.047"	Injektor 1,2 mm	Inyector, tipo 1,2 mm	1
33e	129 140 027	Injecteur 1,4 mm	Injector, model 1.4 mm / 0.055"	Injektor 1,4 mm	Inyector, tipo 1,4 mm	1
35a	050 102 624	Raccord d'air M 1/4 G - M 1/4 NPS	Air fitting, model double male 1/4 G - 1/4 NPS	Luftanschluss AG-AG 1/4NPS	Racor de aire, tipo M 1/4 G - M 1/4 NPS	1
*36	129 760 907	Gâchette + axe de gâchette + vis	Trigger + trigger spindle + screw	Abzugshebel + Achse + Schraube	Gatillo + eje de gatillo + tornillo	1
37	NC / NS	▪ Gâchette	▪ Trigger	▪ Abzugshebel	▪ Gatillo	1
*38 +39	129 140 904	▪ Axe de gâchette (x 5) + vis (x 5)	▪ Trigger spindle (x 5) + screw (x 5)	▪ Abzugsachse (5 St.) + Schraube (5 St.)	▪ Eje de gatillo (x 5) + tornillo (x 5)	1
*40	129 130 030	Pointeau d'air (crosse)	Air adjuster assembly	Spritzstrahlregulier-ventil	Aguja de aire (empuñadura)	1
41	NC / NS	▪ Circlips Ø 6	▪ Ring, model Ø 6	▪ Sicherungsring Ø 6	▪ Anillo truarc, tipo Ø 6	1

Nota : Mettre un injecteur (33) plus petit que la buse ou égal.

Nota : Install an injector (33) smaller or equal to the tip.

Anmerkung : Der installierte Injektor (33) muss kleiner oder gleich groß, wie die eingesetzte Düse sein.

Nota : Instalar un inyector (33) más pequeño que la boquilla o igual.

Pièces spécifiques - Specific parts - Spezifische Teile - Partes específicas

FPRO P LP

Ind	#	Désignation	Description	Bezeichnung	Denominación	Qté
34a	NC / NS	Corps du pistolet	Gun body	Pistolenkörper	Cuerpo de pistola	1

FPRO P CONV

Ind	#	Désignation	Description	Bezeichnung	Denominación	Qté
34b	NC / NS	Corps du pistolet	Gun body	Pistolenkörper	Cuerpo de pistola	1

POCHETTES - KITS - SÄTZE - BOLSAS

Ind	#	Désignation	Description	Bezeichnung	Denominación	Qté
*	129 130 901	Pochette de joints (ind. 3, 6, 8, 10, 14, 15, 26 + tube de graisse)	Seal kit (ind. 3, 6, 8, 10, 14, 15, 26 + grease tube)	Dichtungssatz (Pos. 3, 6, 8, 10, 14, 15, 26 + Tube Fett)	Bolsa de juntas (ind. 3, 6, 8, 10, 14, 15, 26 + tubo de grasa)	1
*	129 770 901	Pochette de maintenance (ind. 16, 17, 19, 20, 22, 24, 28, 29, 31, 37, 38, 39, 40 + pochette de joints + tube de graisse)	Servicing kit (ind. 16, 17, 19, 20, 22, 24, 28, 29, 31, 37, 38, 39, 40 + seal kit + grease tube)	Reparatursatz (Pos. 16, 17, 19, 20, 22, 24, 28, 29, 31, 37, 38, 39, 40 + Dichtungssatz + Tube Fett)	Bolsa de reparación (ind. 16, 17, 19, 20, 22, 24, 28, 29, 31, 37, 38, 39, 40 + bolsa de juntas + tubo de grasa)	1
*	129 770 905	Pochette de maintenance - ligne arrière (ind. 17, 20, 22)	Servicing kit - rear line (ind. 17, 20, 22)	Reparatursatz -Rückseite (Pos. 17, 20, 22)	Bolsa de reparación - linea trasera (ind. 17, 20, 22)	1
*	129 140 022	Pochette injecteur (ind. 33a, 33b, 33c, 33d, 33e)	Injector kit (ind. 33a, 33b, 33c, 33d, 33e)	Injektor Dichtungssatz (Pos. 33a, 33b, 33c, 33d, 33e)	Bolsa inyector (ind. 33a, 33b, 33c, 33d, 33e)	1

OPTION - ON REQUEST - OPTIONEN - OPCIÓN

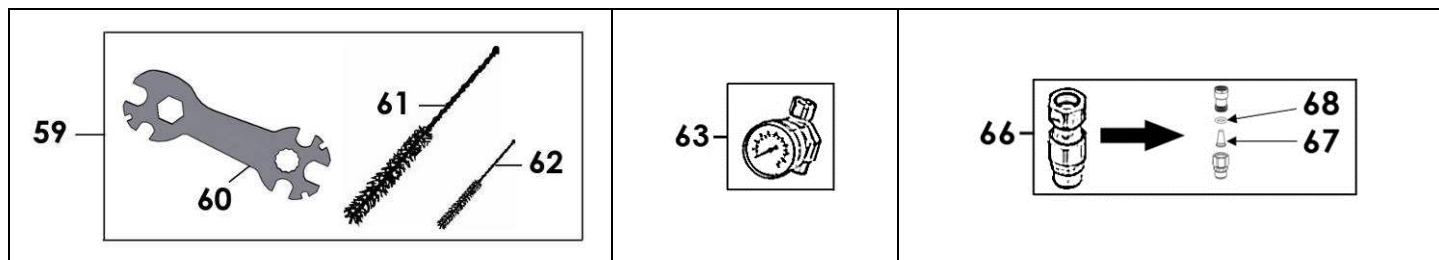

Ind	#	Désignation	Description	Bezeichnung	Denominación	Qté
35b	050 102 217	Raccord d'air M 1/4 G - M 1/4 BSP	Air fitting, model double male 1/4 G - 1/4 BSP	Luftanschluss Doppelnip- pel AG1/4BSP	Racor de aire, tipo M 1/4 G - M 1/4 BSP	1
59	129 760 921	Goupillons et clé	Brushes and wrench	Bürsten und Schlüssel	Cepillos y llave	1
60	049 030 042	▪ Clé plate	▪ Gun wrench	▪ Pistolenschlüssel	▪ Llave para pistola	1
61	906 300 101	▪ Goupillon grand modèle	▪ Large size brush	▪ Reinigungsbürste, groß	▪ Cepillo grande	1
62	906 300 102	▪ Goupillon petit modèle	▪ Little size brush	▪ Reinigungsbürste, klein	▪ Cepillo pequeño	1
63	150 070 560	Manomètre à la crosse (raccords MF 1/4 NPS)	Handle gauge (fittings : 1/4 NPS male - 1/4 NPS female)	Manometer für den Griff (Anschlüsse : AG 1/4 NPS - IG 1/4 NPS)	Manómetro a la empuñadura (racores : MH 1/4 NPS)	1
66	129 140 030	Filtre arrivée produit MF 3/8 NPS	Fluid in-line filter (MF 3/8 NPS)	Inline Materialfilter (IG 3/8 NPS x AG 3/8 NPS)	Filtro llegada producto (M 3/8 NPS - H 3/8 NPS)	1
67	151 399 902	▪ Tamis n° 6 (x 10)	▪ Screen n° 6 (x 10)	▪ Sieb Nr. 6 (10 St.)	▪ Tamiz n° 6 (x 10)	1
68	149 949 901	▪ Joint (x 10)	▪ Seal (x 10)	▪ Dichtung (10 St.)	▪ Junta (x 10)	1

* Pièces de maintenance préconisées.

* Preceding the index number denotes a suggested spare part.

* Bezeichnete Teile sind empfohlene Ersatzteile.

* Piezas de mantenimiento preventivas.

N C : Non commercialisé

N S : Denotes parts are not serviceable.

N S : Bezeichnete Teile gibt es nicht einzeln, sondern nur
komplett.

N S : no suministrado.

Doc. 573.496.050 Date/Datum/Fecha : 27/07/17 Annule/Cancel/Ersetzt/Anula :	Modif. / Änderung :	Pièces de rechange Spare parts list Ersatzteilliste Piezas de repuesto
---	----------------------------	---

**FPRO P
LOCK LP - LOCK CONV**

**PISTOLET PNEUMATIQUE / AIRSPRAY GUN
PNEUMATISCHE PISTOLE / PISTOLA NEUMÁTICA**

F PRO LOCK P LP (HVLP)		F PRO LOCK P LP (LVLP)	
(☐)	#	(☐)	#
	135.760.000		135.760.000
+ HVLP-09-Lva	135.767.409	+ LVLP-09-Lva	135.760.409
+ HVLP-12-Lva	135.767.412	+ LVLP-12-Lva	135.760.412
+ HVLP-09 XLva	135.767.509	+ LVLP-09-XLva	135.760.509
+ HVLP-12-XLva	135.767.512	+ LVLP-12-XLva	135.760.512

F PRO LOCK P CONV	
(☐)	#
	135.764.000
+ CONV-15-Lva	135.764.415
+ CONV-18-Lva	135.764.418
+ CONV-15-XLva	135.764.515
+ CONV-18-XLva	135.764.518

(☐) : pistolet sans projecteur / gun without projector / Pistole ohne Zerstäubereinheit / Pistola sin proyector

FPRO LOCK P LP	Standard / Estándar
-----------------------	----------------------------

Projecteur / Projector / Zerstäubereinheit / Proyector		Tête / Aircap Luftkappe / Cabezal		Buse / Nozzle Düse / Boquilla			Pointeau / Needle Nadel / Aguja	
Ind. 1+7+11	#	Ind. 1	#	Ind. 7	Ø (mm / ")	#	Ind. 11	#
HVLP-07-Lva	131 767 407	HVLP -07 22 -Lva	132 767 400	07	0,7 / 0.028	134 130 100	07- 09 -12	033 140 100
HVLP-09-Lva	131 767 409			09	0,9 / 0.035	134 130 200		
HVLP-12-Lva	131 767 412			12	1,2 / 0.047	134 130 300		
HVLP-15-Lva	131 767 415			15	1,5 / 0.059	134 130 600	15 - 18	033 140 200
HVLP-18-Lva	131 767 418			18	1,8 / 0.071	134 130 700		
HVLP-07-XLva	131 767 507	HVLP -07 22 -XLva	132 767 500	07	0,7 / 0.028	134 130 100	07- 09 -12	033 140 100
HVLP-09-XLva	131 767 509			09	0,9 / 0.035	134 130 200		
HVLP-12-XLva	131 767 512			12	1,2 / 0.047	134 130 300		
HVLP-15-XLva	131 767 515			15	1,5 / 0.059	134 130 600	15 - 18	033 140 200
HVLP-18-XLva	131 767 518			18	1,8 / 0.071	134 130 700		
LVLP-07-Lva	131 760 407	LVLP -07 22 -Lva	132 760 400	07	0,7 / 0.028	134 130 100	07- 09 -12	033 140 100
LVLP-09-Lva	131 760 409			09	0,9 / 0.035	134 130 200		
LVLP-12-Lva	131 760 412			12	1,2 / 0.047	134 130 300		
LVLP-15-Lva	131 760 415			15	1,5 / 0.059	134 130 600	15 - 18	033 140 200
LVLP-18-Lva	131 760 418			18	1,8 / 0.071	134 130 700		
LVLP-07-XLva	131 760 507	LVLP -07 22 -XLva	132 760 500	07	0,7 / 0.028	134 130 100	07- 09 -12	033 140 100
LVLP-09-XLva	131 760 509			09	0,9 / 0.035	134 130 200		
LVLP-12-XLva	131 760 512			12	1,2 / 0.047	134 130 300		
LVLP-15-XLva	131 760 515			15	1,5 / 0.059	134 130 600	15 - 18	033 140 200
LVLP-18-XLva	131 760 518			18	1,8 / 0.071	134 130 700		

FPRO LOCK P CONV	Standard / Estándar
-------------------------	----------------------------

Projecteur / Projector / Zerstäubereinheit / Proyector		Tête / Aircap Luftkappe / Cabezal		Buse / Nozzle Düse / Boquilla			Pointeau / Needle Nadel / Aguja	
Ind. 1+7+11	#	Ind. 1	#	Ind. 7	Ø (mm / ")	#	Ind. 11	#
CONV-07-Lva	131 764 407	CONV -07 22-Lva	132 764 400	07	0,7 / 0.028	134 130 100	07 - 09 - 12	033 140 100
CONV-09-Lva	131 764 409			09	0,9 / 0.035	134 130 200		
CONV-12-Lva	131 764 412			12	1,2 / 0.047	134 130 300		
CONV-15-Lva	131 764 415			15	1,5 / 0.059	134 130 600	15 - 18	033 140 200
CONV-18-Lva	131 764 418			18	1,8 / 0.071	134 130 700		
CONV-07-XLva	131 764 507	CONV -07 22 -XLva	132 764 500	07	0,7 / 0.028	134 130 100	07 - 09 - 12	033 140 100
CONV-09-XLva	131 764 509			09	0,9 / 0.035	134 130 200		
CONV-12-XLva	131 764 512			12	1,2 / 0.047	134 130 300		
CONV-15-XLva	131 764 515			15	1,5 / 0.059	134 130 600	15 - 18	033 140 200
CONV-18-XLva	131 764 518			18	1,8 / 0.071	134 130 700		

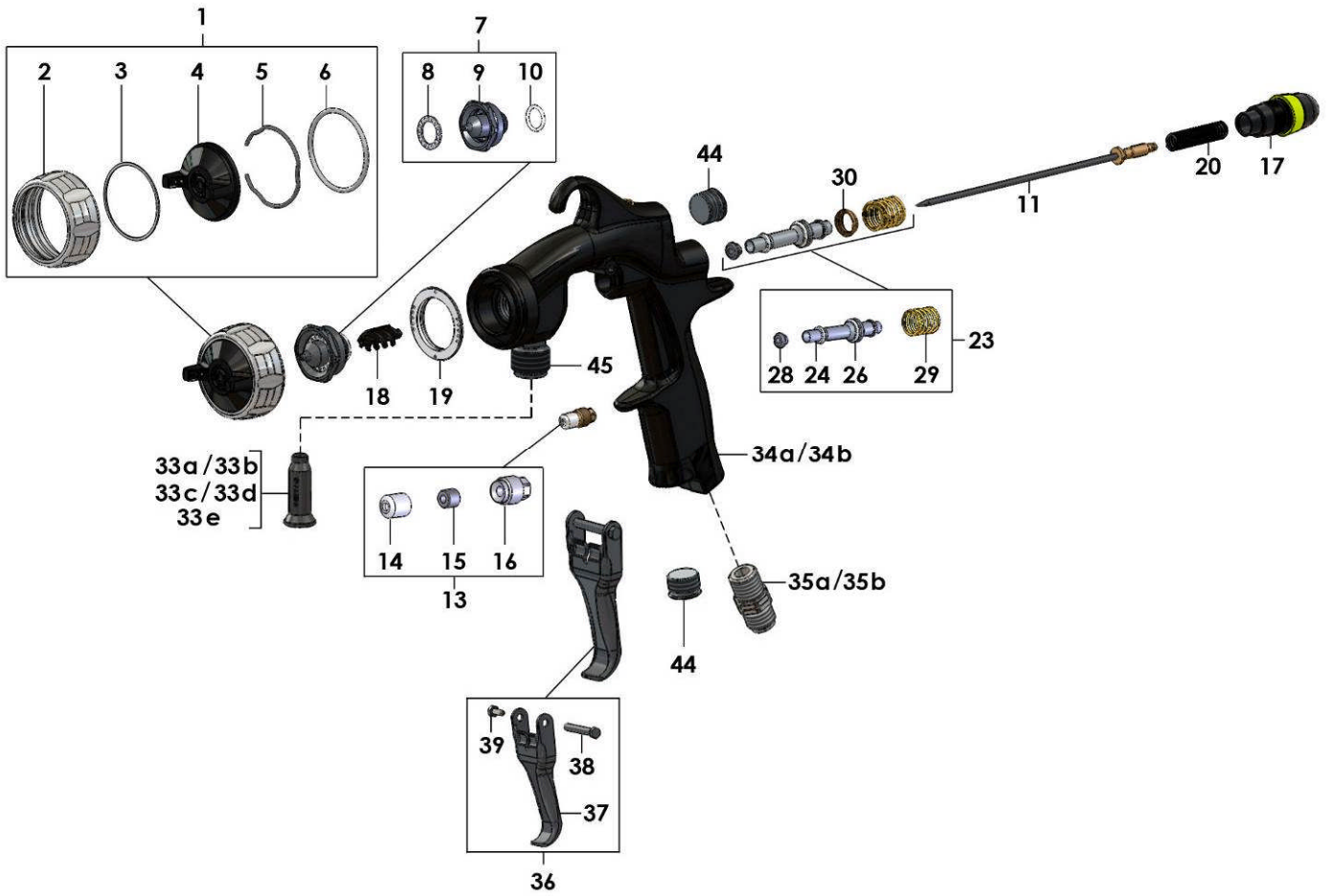

Pièces communes - Common parts - Gleiche Teile - Partes comunes

Ind	#	Désignation	Description	Bezeichnung	Denominación	Qté
*1	-	Tête complète (voir tableau)	Aircap assembly (refer to chart)	Luftkappe kpl. (siehe Tabelle)	Cabezal complet (consultar cuadro)	1
2	032 760 005	▪ Bague de tête	▪ Aircap ring	▪ Haltering	▪ Anillo del cabezal	1
3	129 080 007	▪ Joint de tête (x 2)	▪ Seal, aircap (x 2)	▪ O-Ring (2 St.)	▪ Junta de cabezal (x 2)	1
4	NC / NS	▪ Tête nue	▪ Aircap only	▪ Luftkappe	▪ Cabezal solo	1
5	NC / NS	▪ Anneau de retenue	▪ Stop ring	▪ Sicherungsring	▪ Anillo de retención	1
6	150 040 309	▪ Joint de bague (x 10)	▪ Seal, ring (x 10)	▪ O-Ring (10 St.)	▪ Junta del anillo (x 10)	1
*7	-	Buse équipée (voir tableau)	Nozzle assembly (refer to chart)	Düse kpl. (siehe Tabelle)	Boquilla equipada (consultar cuadro)	1
*8	129 130 004	▪ Bague de répartition (x 5)	▪ Distribution ring (x 5)	▪ Luftverteiler (5 St.)	▪ Anillo de distribución (x 5)	1
9	NC / NS	▪ Buse	▪ Nozzle	▪ Düse	▪ Boquilla	1
10	129 209 902	▪ Joint de buse (x 5)	▪ Seal, nozzle (x 5)	▪ O-Ring, Düse (5 St.)	▪ Junta de boquilla (x 5)	1
*11	-	Pointeau (voir tableau)	Needle (refer to chart)	Farbnadel (siehe Tabelle)	Aguja (consultar cuadro)	1
13	129 130 903	Garniture pointeau (x 5)	Packing, needle (x 5)	Nadelgarnitur (5 St.)	Guarnición de aguja (x 5)	1
14	NC / NS	▪ Siège (x 5)	▪ Seat (x 5)	▪ Sitz (5 St.)	▪ Asiento (x 5)	1
15	NC / NS	▪ Palier (x 5)	▪ Bearing (x 5)	▪ Plastikeinsatz (5 St.)	▪ Palier (x 5)	1
16	029 130 006	▪ Presse-garniture (x 1)	▪ Packing holder (x 1)	▪ Packungsschraube (1 St.)	▪ Prensa-guarnición (x 1)	1
17	129 760 001	Fourreau	Sleeve, needle stop	Nadelführung	Manguito	1
18	129 140 031	Vortex (x 1)	Vortex (x 1)	Vortex (x 1)	Vortex (x 1)	1
19	129 130 003	Bague de répartition (x 5)	Distribution ring (x 5)	Luftverteiler (5 St.)	Anillo de distribución (x 5)	1
*20	050 311 248	Ressort de pointeau	Spring, needle	Farbnadelfeder	Muelle de aguja	1
*23	129 030 020	Soupape d'air complète	Air valve assembly	Luftventil kpl.	Válvula de aire completa	1
24	NC / NS	▪ Corps de soupape	▪ Body, air valve	▪ Luftventilkörper	▪ Cuerpo de válvula	1
26	129 030 022	▪ Joint de soupape (x 10)	▪ Seal, air valve (x 10)	▪ Dichtung (10 St.)	▪ Junta de válvula (x 10)	1
*28	129 030 026	▪ Entraîneur (x 5)	▪ Carrier (x 5)	▪ Mitnehmer (5 St.)	▪ Arrastre (x 5)	1
*29	050 311 321	▪ Ressort de soupape	▪ Spring, valve	▪ Ventulfeder	▪ Muelle de válvula	1
30	129 140 008	Butée de soupape	Air valve stop	Luftventilanschlag	Tope de válvula	1

Ind	#	Désignation	Description	Bezeichnung	Denominación	Qté
33a	129 140 023	Injecteur 0,8 mm	Injector, model 0.8 mm / 0.031"	Injektor 0,8 mm	Inyector, tipo 0,8 mm	1
33b	129 140 024	Injecteur 0,9 mm	Injector, model 0.9 mm / 0.035"	Injektor 0,9 mm	Inyector, tipo 0,9 mm	1
33c	129 140 025	Injecteur 1,0 mm	Injector, model 1.0 mm / 0.039"	Injektor 1 mm	Inyector, tipo 1,0 mm	1
33d	129 140 026	Injecteur 1,2 mm	Injector, model 1.2 mm / 0.047"	Injektor 1,2 mm	Inyector, tipo 1,2 mm	1
33e	129 140 027	Injecteur 1,4 mm	Injector, model 1.4 mm / 0.055"	Injektor 1,4 mm	Inyector, tipo 1,4 mm	1
35a	050 102 624	Raccord d'air M 1/4 G - M 1/4 NPS	Air fitting, model double male 1/4 G - 1/4 NPS	Luftanschluss AG-AG 1/4NPS	Racor de aire, tipo M 1/4 G - M 1/4 NPS	1
*36	129 760 907	Gâchette + axe de gâchette + vis	Trigger + trigger spindle + screw	Abzugshebel + Achse + Schraube	Gatillo + eje de gatillo + tornillo	1
37	NC / NS	▪ Gâchette	▪ Trigger	▪ Abzugshebel	▪ Gatillo	1
*38 +39	129 140 904	▪ Axe de gâchette (x 5) + vis (x 5)	▪ Trigger spindle (x 5) + screw (x 5)	▪ Abzugsachse (5 St.) + Schraube (5 St.)	▪ Eje de gatillo (x 5) + tornillo (x 5)	1
44	129 650 002	Bouchon	Plug	Stopfen	Tapón	2
45	029 140 005	Raccord produit	Fluid fitting	Materialanschluss	Racor producto	1

Nota : Mettre un injecteur (33) plus petit que la buse ou égal.

Nota : Install an injector (33) smaller or equal to the tip.

Anmerkung : Der installierte Injektor (33) muss kleiner oder gleich groß, wie die eingesetzte Düse sein.

Nota : Instalar un inyector (33) más pequeño que la boquilla o igual.

Pièces spécifiques - Specific parts - Spezifische Teile - Partes específicas

FPRO LOCK P LP

Ind	#	Désignation	Description	Bezeichnung	Denominación	Qté
34a	NC / NS	Corps du pistolet	Gun body	Pistolenkörper	Cuerpo de pistola	1

FPRO LOCK P CONV

Ind	#	Désignation	Description	Bezeichnung	Denominación	Qté
34b	NC / NS	Corps du pistolet	Gun body	Pistolenkörper	Cuerpo de pistola	1

POCHETTES - KITS - SÄTZE - BOLSAS

Ind	#	Désignation	Description	Bezeichnung	Denominación	Qté
*	129 130 901	Pochette de joints (ind. 3, 6, 8, 10, 14, 15, 26 + tube de graisse)	Seal kit (ind. 3, 6, 8, 10, 14, 15, 26 + grease tube)	Dichtungssatz (Pos. 3, 6, 8, 10, 14, 15, 26 + Tube Fett)	Bolsa de juntas (ind. 3, 6, 8, 10, 14, 15, 26 + tubo de grasa)	1
*	129 760 901	Pochette de maintenance (ind. 16, 17, 19, 20, 24, 28, 29, 37, 38, 39, 44(x2) + pochette de joints + tube de graisse)	Servicing kit (ind. 16, 17, 19, 20, 24, 28, 29, 37, 38, 39, 44(x2) + seal kit + grease tube)	Reparatursatz (Pos. 16, 17, 19, 20, 24, 28, 29, 37, 38, 39, 44(x2) + Dichtungssatz + Tube Fett)	Bolsa de reparación (ind. 16, 17, 19, 20, 24, 28, 29, 37, 38, 39, 44(x2) + bolsa de juntas + tubo de grasa)	1
*	129 760 905	Pochette de maintenance - ligne arrière (ind. 17, 20)	Servicing kit - rear line (ind. 17, 20)	Reparatursatz - Rückseite (Pos. 17, 20)	Bolsa de reparación - línea trasera (ind. 17, 20)	1
*	129 140 022	Pochette injecteur (ind. 33a, 33b, 33c, 33d, 33e)	Injector kit (ind. 33a, 33b, 33c, 33d, 33e)	Injektor Dichtungssatz (Pos. 33a, 33b, 33c, 33d, 33e)	Bolsa inyector (ind. 33a, 33b, 33c, 33d, 33e)	1

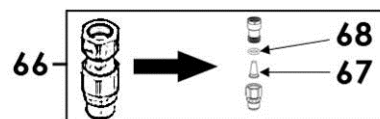
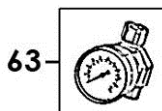
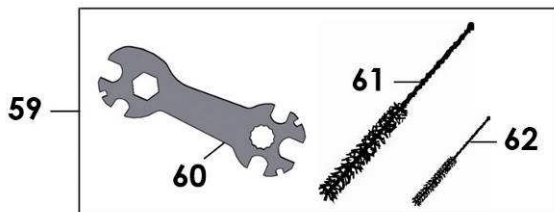
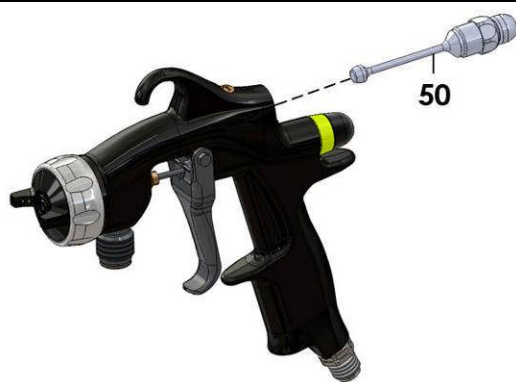

Ind	#	Désignation	Description	Bezeichnung	Denominación	Qté
35b	050 102 217	Raccord d'air M 1/4 G - M 1/4 BSP	Air fitting, model double male 1/4 G - 1/4 BSP	Luftanschluss Doppelnippel AG1/4BSP	Racor de aire, tipo M 1/4 G - M 1/4 BSP	1
50	129 130 040	Pointeau d'air (évents) verrouillable	Lockable air adjuster assembly	Spritzstrahlregulier- ventil, komplett	Aguja de aire (eventos) bloqueable	1
59	129 760 921	Goupillons et clé	Brushes and wrench		Cepillos y llave	1
60	049 030 042	▪ Clé plate	▪ Gun wrench	▪ Pistolenschlüssel	▪ Llave para pistola	1
61	906 300 101	▪ Goupillon grand modèle	▪ Large size brush	▪ Reinigungsbürste, groß	▪ Cepillo grande	1
62	906 300 102	▪ Goupillon petit modèle	▪ Little size brush	▪ Reinigungsbürste, klein	▪ Cepillo pequeño	1
63	150 070 560	Manomètre à la crosse (raccords MF 1/4 NPS)	Handle gauge (fittings : 1/4 NPS male - 1/4 NPS female)	Manometer für den Griff (Anschlüsse : AG 1/4 NPS - IG 1/4 NPS)	Manómetro a la empuñadura (racores : MH 1/4 NPS)	1
66	129 140 030	Filtre arrivée produit MF 3/8 NPS	Fluid in-line filter (MF 3/8 NPS)	Inline Materialfilter (3/8 NPS IG x 3/8 NPS AG)	Filtro llegada producto (M 3/8 NPS - H 3/8 NPS)	1
67	151 399 902	▪ Tamis n° 6 (x 10)	▪ Screen n° 6 (x 10)	▪ Sieb Nr 6 (10 St.)	▪ Tamiz n° 6 (x 10)	1
68	149 949 901	▪ Joint (x 10)	▪ Seal (x 10)	▪ Dichtung (10 St.)	▪ Junta (x 10)	1

* Pièces de maintenance préconisées.

* Preceding the index number denotes a suggested spare part.

* Bezeichnete Teile sind empfohlene Ersatzteile.

* Piezas de mantenimiento preventivas.

N C : Non commercialisé

N S : Denotes parts are not serviceable.

N S : Bezeichnete Teile gibt es nicht einzeln, sondern nur
komplett.

N S : no suministrado.

ALLONGE - EXTENSION - VERLÄNGERUNG - ALARGADERA
Ø 8 MM / 0.31"



Ind	#	Désignation	Description	Bezeichnung	Denominación	Qté
-	-	Jet rond Longueur : 150 mm	Cone fan Length : 150 mm / 5.9"	Rundstrahl Länge : 150 mm	Abanico redondo Longitud : 150 mm	-
-	075 900 213	▪ Buse de 12	▪ Nozzle, model 12	▪ Düse Gr. 12	▪ Boquilla de 12	1
-	075 900 224	▪ Buse de 18	▪ Nozzle, model 18	▪ Düse Gr. 18	▪ Boquilla de 18	1
-	-	Jet latéral Longueur : 250 mm	Lateral fan Length : 250 mm / 9.8"	Seitenstrahl Länge : 250 mm	Abanico lateral Longitud : 250 mm	-
-	075 900 111	▪ Buse de 12	▪ Nozzle, model 12	▪ Düse Gr. 12	▪ Boquilla de 12	1
-	075 900 122	▪ Buse de 18	▪ Nozzle, model 18	▪ Düse Gr. 18	▪ Boquilla de 18	1
-	-	Jet latéral Longueur : 400 mm	Lateral fan Length : 400 mm / 15.7"	Seitenstrahl Länge : 400 mm	Abanico lateral Longitud : 400 mm	-
-	075 900 311	▪ Buse de 12	▪ Nozzle, model 12	▪ Düse Gr. 12	▪ Boquilla de 12	1
-	075 900 322	▪ Buse de 18	▪ Nozzle, model 18	▪ Düse Gr. 18	▪ Boquilla de 18	1

* Pièces de maintenance préconisées.

* Preceding the index number denotes a suggested spare part.

* Bezeichnete Teile sind empfohlene Ersatzteile.

* Piezas de mantenimiento preventivas.

N C : Non commercialisé

N S : Denotes parts are not serviceable.

N S : Bezeichnete Teile gibt es nicht einzeln, sondern nur komplett.

N S : no suministrado.



MANUAL AIRSPRAY GUN

PREVENTIVE MAINTENANCE

TRANSLATION FROM THE ORIGINAL MANUAL

IMPORTANT : Before assembly and start-up, please read and clearly understand all the documents relating to this equipment (professional use only).

THE PICTURES AND DRAWINGS ARE NON CONTRACTUAL. WE RESERVE THE RIGHT TO MAKE CHANGES WITHOUT PRIOR NOTICE.

SAMES KREMLIN SAS
13, chemin de Malacher
38 240 - MEYLAN - France
☎ : 33 (0)4 76 41 60 60

www.sames-kremlin.com



Safety instructions :

- Never try to stop the spray fan with any part of the body (hands, fingers...) or with rags.
- The operator will need medical attention if the high pressure material spray is in contact with the body (eyes, fingers...).
- **Always lock the gun trigger with the safety device when not operating the gun.**
- **Always depressurize air and hoses** before carrying out any servicing on the gun.



In order to protect the operator, protective clothing (gloves, respirator mask, glasses, hearing protective earplug, clothes...) are required.



Use the equipment in a properly ventilated area.

This spray gun is a precision tool. Its correct functioning requires regular maintenance, carried out with care. When it is carried out directly after use, the cleaning of the gun is faster and easier.

- ➔ **Never use metallic brushes, files or pliers when dismantling the gun.**



Before any action on the gun,

- Shut off the compressed air supply,
- Depressurize the systems by triggering the gun.

Do not use fluid which would quickly clog the nozzle.
Air supply should be clean.

▪ **SHORT DURATION SHUTDOWN (LESS THAN 3 HOURS)**

Leave the equipment as it is. In any case, if the aircap becomes a little clogged with material, it is best to clean it with a brush and some solvent.

▪ **LONG DURATION SHUTDOWN**

Shut off the gun air and fluid supply.

Change material with solvent and trigger the gun to depressurize the hoses and flush the pump, the hoses and the gun.

Unscrew the air cap. Remove the needle and then remove the fluid nozzle with the wrench provided. Soak the needle, aircap, fluid nozzle in solvent and brush them carefully, as they are precision parts.

With a brush soaked in solvent, clean the internal parts of the gun. Wash and carefully brush the treated parts.

If a cup fits the gun, put a cover on the cup to prevent from the paint drying. If not, empty out the paint and replace it with solvent. Clean the inside and outside part of the cup with a brush soaked in solvent.

- ➔ **Do not soak the gun in solvent.**

- ➔ **Use only products or solvent compatible with the parts in contact with the material (refer to data sheet of the material manufacturer).**



MANUAL AIRSPRAY GUN

TROUBLESHOOTING GUIDE

TRANSLATION FROM THE ORIGINAL MANUAL

IMPORTANT : Before assembly and start-up, please read and clearly understand all the documents relating to this equipment (professional use only).

THE PICTURES AND DRAWINGS ARE NON CONTRACTUAL. WE RESERVE THE RIGHT TO MAKE CHANGES WITHOUT PRIOR NOTICE.

SAMES KREMLIN SAS
13, chemin de Malacher
38 240 - MEYLAN - France
☎ : 33 (0)4 76 41 60 60

www.sames-kremlin.com

▪ **DISTORTED SPRAY**

Slightly unscrew the aircap retaining ring and rotate the aircap by one half turn. If the defect is reversed, one of the lateral air holes is plugged up or deformed. Clean the gun aircap with solvent and unclog the air holes with a compressed air. If the defect is not reversed, it means that the fluid nozzle is damaged.

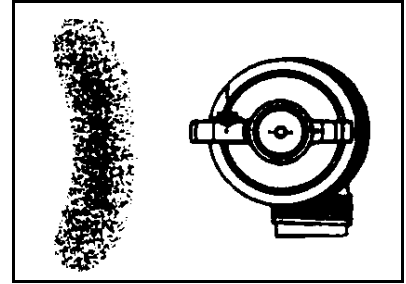

▪ **DISPLACED SPRAY**

This comes from a defect in the central fan. Clean the aircap and the fluid nozzle. Make sure that :

- the aircap is correctly centered on the nozzle,
- the nozzle is not too big for the needle,
- when work is done with a large needle opening and the needle almost closed, the spray pattern is not even in all directions.

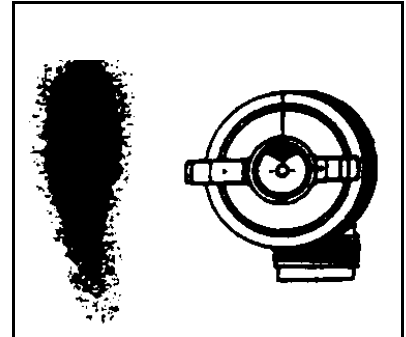

▪ **FRAGMENTED PATTERN**

The fan air pressure is too high at the holes in the air cap horns :

- turn the fan air control clockwise to reduce the fan air pressure,
- increase the paint output.

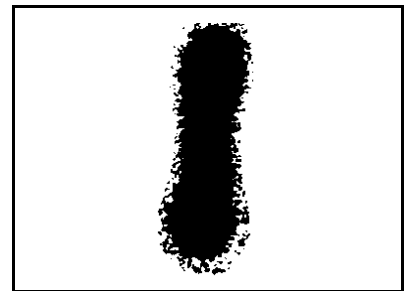

▪ **FAN TOO THICK IN THE CENTER**

This is the reverse of the above defect :

- the paint output is too high for the selected air pressure : increase the spraying air pressure and reduce the paint output.
- if the paint is too thick, dilute it.

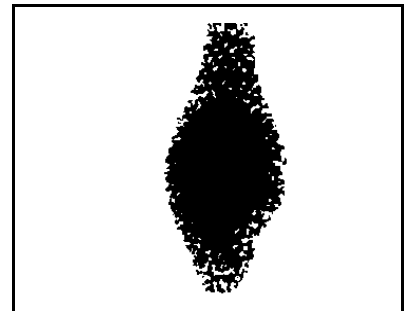

▪ **INTERMITTANT SPRAY PATTERN**

An air inlet in the paint circuit creates an intermittant pattern when :

- the paint cup is nearly empty,
- when the nozzle is not tightened on its seat : clamp it.

If the problem persists, remove the nozzle and clean it. Check that the seat and the cone are not damaged, remove the nozzle and clamp it.

Check that : the cup cover air hole is not blocked and the paint is homogeneous and fluid enough (use the viscosity cup).

Check that the 'pressure' gun is not used with a 'suction' cup.

TROUBLE	CAUSE	SOLUTION
No fluid out of the gun	Clogged nozzle	Cut the pressure on the pump. Depressurize the hoses. Remove and clean the nozzle with solvent by means of the brush. Check the seal condition.
Pattern width narrows during reversing phase of pump	Air trapped in the fluid circuit	Check connections and suction hose quality.
	Viscosity too high	Reduce viscosity.
Aircap becomes dirty frequently	Too much atomizing air	Reduce air pressure.
Fluid seeping from the air holes of the aircap	Defective tip seal	Replace it.
	Tip loose	Tighten it.
Fluid leak at the packing	Packing is worn	Tighten up the packing holder without blocking the needle. If there is still a leak, replace the packing and the needle.
Fluid leak at the front part of the gun, trigger released	Impurities in the paint	Trigger the gun 3 or 4 times.
	Needle worn or/and nozzle worn	Replace needle and nozzle.
Air leak at the valve	Valve worn	Change the valve.
Permanent air leak at the gun aircap when the trigger is released	Friction on the needle	Remove the trigger and check the needle.
	Valve worn	Replace the valve.



PNEUMATIC MANUAL SPRAY GUN

START-UP, ADJUSTMENTS AND HANDLING

TRANSLATION FROM THE ORIGINAL MANUAL

IMPORTANT : Before assembly and start-up, please read and clearly understand all the documents relating to the equipment (professional use only).

THE PICTURES AND DRAWINGS ARE NOT CONTRACTUAL. WE RESERVE THE RIGHT TO MAKE CHANGES WITHOUT PRIOR NOTICE.

SAMES KREMLIN SAS
13, chemin de Malacher
38 240 - MEYLAN - France
☎ : 33 (0)4 76 41 60 60

www.sames-kremlin.com

1. START-UP



Safety instructions :

- Never try to stop the spray fan with any part of the body (hands, fingers...) or with rags. Never point the spray gun at anyone or at any part of the body.
- The operator will need medical attention if the high pressure material spray is in contact with the the body (eyes, fingers...).
- **Always depressurize air and hoses** before carrying out any servicing on the gun.



In order to protect the operator, protective clothing (gloves, respirator mask, glasses, hearing protective earplug, clothes...) are required.

Use the equipment in a properly ventilated area.

- 1- Unscrew the needle adjustment knob at the back of the gun.
 - 2- Unscrew the air adjuster(s) (except for the Fpro Lock P spray gun).
 - 3- Select the desired projector (aircap + nozzle + needle) best suited for the job at hand.
 - 4- Screw on the nozzle, then the aircap to the gun.
- ➡ We advice you to put the gun in the 'OPEN' position to prevent any damage to the needle while fitting the nozzle
- 5 -Before tightening up firmly the aircap ring, position the aircap for the best spray. The fan is vertical when the 2 'ears' of the aircap are horizontal.
 - 6 - Trigger the gun.

2. ADJUSTMENT

This professional spray gun features 3 controls :

▪ SPRAYING FINENESS

It is realized by the central air. The air is adjusted by means of the air regulator mounted upstream of the gun on the network and more finely by means of the knob at the bottom of the gun handle of some manual guns (optional for the Fpro Lock P spray gun).

▪ FAN WIDTH (optional for the Fpro Lock P spray gun)

Can be adjusted by using the knurled knob. It controls the air going to the horns on the aircap. In this way, the air is controlled through the fanned air outlets and allows the fan to change from flat (wide open) to round (closed).

▪ FLUID OUTPUT

Having selected the proper fluid nozzle / needle assembly and the fluid pressure, it is possible to further control the output by changing the travel of the needle (needle stop knob) (optional for the Fpro Lock P spray gun).

Optimal set-up is usually obtained when the product needle is completely open. When this needle is nearly closed, a regular flow of product can not be guaranteed.

3. GUN HANDLING

When mounting the aircap on the gun, hold it vertically in order to correctly adjust the aircap before screwing the aircap ring.

Keep the gun perpendicular to the surface to be painted. Avoid working with the wrist.

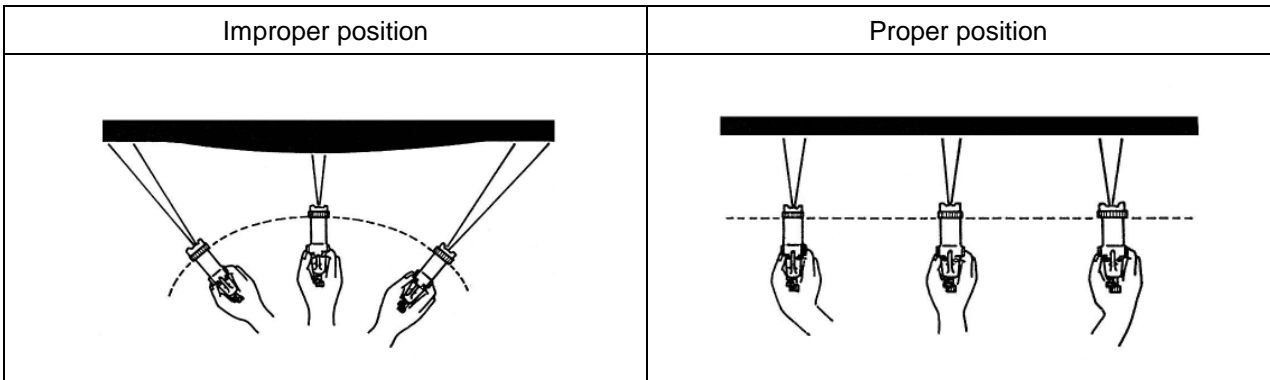

Do not forget that crossed sweeps cannot correct irregularities.

Spraying from a stationary gun will not give you even coverage. Start the pass and trigger just before the leading edge. Release the trigger before the pass ends, just after the trailing edge of the object.

Make sure that overlapping from the passes is even.



AIRSPRAY GUN

FPro P

TECHNICAL FEATURES

TRANSLATION FROM THE ORIGINAL MANUAL

IMPORTANT : Before assembly and start-up, please read and clearly understand all the documents relating to the equipment (professional use only).

THE PICTURES AND DRAWINGS ARE NOT CONTRACTUAL. WE RESERVE THE RIGHT TO MAKE CHANGES WITHOUT PRIOR NOTICE.

SAMES KREMLIN SAS
13, chemin de Malacher
38 240 - MEYLAN - France
☎ : 33 (0)4 76 41 60 60
www.sames-kremlin.com

1. DESCRIPTION

The FPro P gun is an airspray gun for professional use only.

There are 4 versions of the gun :

- FPro P LP,
- FPro P CONV,
- FPro Lock P LP,
- FPro Lock P CONV.

2. FPRO P LP - FPRO P CONV - FPRO LOCK P LP - FPRO LOCK P CONV

2.1. Description

Guns recommended to spray varnishes, lacquers, shades, polyurethanes, two components,...

The FPro P LP and FPRO LOCK P LP guns are pneumatic guns with a high transfer efficiency. A projector, model HVLP/LVLP can be fitted on the gun for small rates. For higher rates, we recommend the use of projectors, model CONV-23 27-Lvb, CONV-23 27-Mvb, CONV-23 27-Srb and CONV-33 40-Srb.

The FPro P CONV and FPRO LOCK P CONV guns, with high spraying quality, enable to spray any kind of materials (low or high viscosity).

2.2. Technical features

FEATURES	FPro P LP / FPRO LOCK P LP		FPro P CONV / FPRO LOCK P CONV	
	+ HVLP aircap	+ LVLP aircap	+ CONV aircap	
Version	pressure			
Maximum air supply pressure (network)	6 bar / 87 psi			
Air pressure at the gun handle	From 1.5 to 2.5 bar / from 22 to 36 psi		From 2.5 to 3.5 bar / from 36 to 50.7 psi	
Air flow	From 16.1 to 23.5 m ³ /h / from 9.5 to 13.8 CFM		From 21.8 to 28.2 m ³ /h / from 12.8 to 16.6 CFM	
Fluid supply maximum pressure	6 bar / 87 psi			
Weight	495 g / 1.09 lb	381 g / 0.84 lb	495 g / 1.09 lb	381 g / 0.84 lb
Shades and hydro or solvent based varnishes				
- low viscosity	***	**	***	
- medium viscosity	****	****	****	
- high viscosity	**	**	****	
Transfer rate (EN 13966-1 standard) (1)	78 % ± 2 %	72 % ± 2 %	66 % ± 2 %	
Maximum fluid temperature	50°C / 120°F			
Wetted parts	Nozzle, fluid passage : Stainless steel, POM C, Polypropylene Needle : stainless steel treated Body, trigger : Aluminium			
Weighted sound pressure (LAeq) (under pressure / with tip, model 12)	86.3 dBa			

(1) : Paint viscosity : 20 s CA n° 4 - 20°C / Gun aircap distance - surface to be painted : 20 cm

Nota : For the LP gun fitted with one of the HVLP aircaps, the maximum inlet air pressure at the gun handle must not exceed 2 bar / 29 psi to maintain 0.7 bar / 10.1 psi or less at the aircap.

■ AIR AND FLUID SUPPLY

FPro P & FPro Lock P guns	Fittings mounted on the gun	Air and fluid supply
Air	Male 1/4 NPS	Air hose (non-static hose) LP : minimum \varnothing 8 mm ID (for a 7.5 m / 24.6 ft length) CONV : minimum \varnothing 7 mm ID (for a 7.5 m / 24.6 ft length)
Fluid	Male 3/8 NPS	For pressure gun (LP & CONV) : Fluid hose : minimum \varnothing 7 mm ID (for a 7.5 m / 24.6 ft length)

▪ **PRESSURE AND AIR CONSUMPTION OF THE GUNS**

Air pressure adjustment with or without gauge at the gun handle

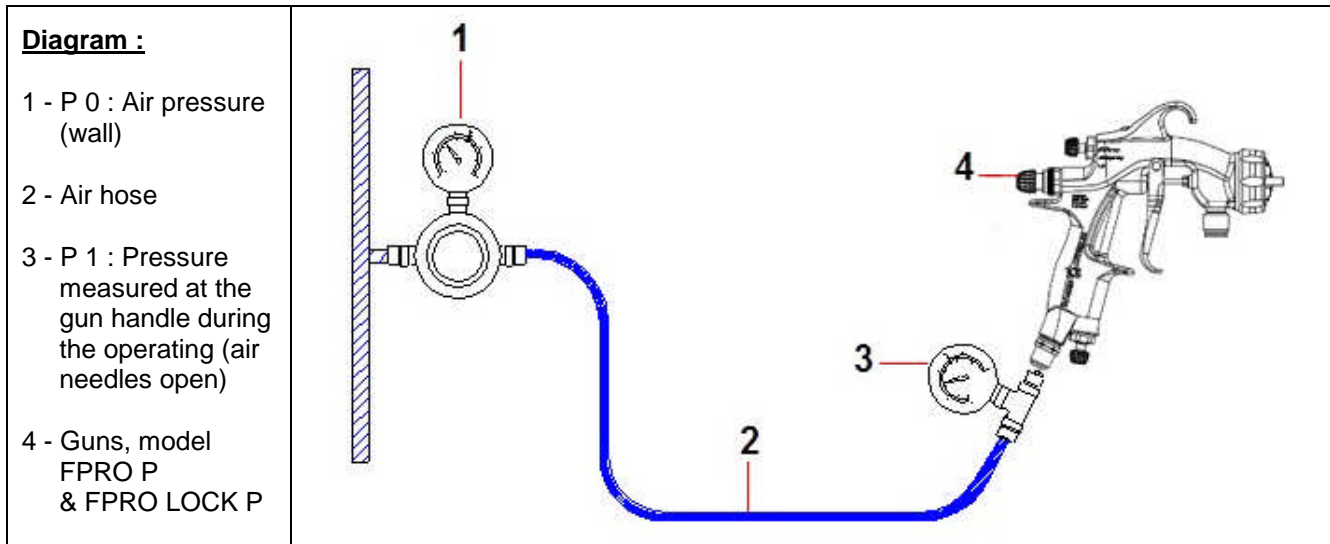

Gun, model FPRO P LP + HVLP aircap + hose Ø 8 mm, 7.5 m / 24.6 ft length									
P 0		P 1		Air flow rate		Fluid flow (2)		Fan width (3)	
bar	psi	bar	psi	m3/h	CFM	g/mn	oz/mn	cm	"
2,2	32	1,5	22	16,1	9.4	250	8.8	40	15.7
3	44	2	29	20,2	11.8	250	8.8	41	16.1
3,5	51	2,5	36	23,5	13.8	250	8.8	42	16.5
4,1	60	3	44	27,2	16				
4,7	68	3,5	51	30,6	18				

Gun, model FPRO P LP + LVLP aircap + hose Ø 8 mm, 7.5 m / 24.6 ft length									
P 0		P 1		Air flow rate		Fluid flow (2)		Fan width (3)	
bar	psi	bar	psi	m3/h	CFM	g/mn	oz/mn	cm	"
2,2	32	1,5	22	15	8.8	250	8.8	40	15.7
3	44	2	29	18,8	11	250	8.8	41	16.1
3,5	51	2,5	36	21,9	12.9	250	8.8	42	16.5
4,1	60	3	44	25,3	14.9				
4,7	68	3,5	51	28,5	16.7				

Gun, model FPRO P CONV + CONV aircap + hose Ø 7 mm, 7.5 m / 24.6 ft length									
P 0		P 1		Air flow rate		Fluid flow (2)		Fan width (3)	
bar	psi	bar	psi	m3/h	CFM	g/mn	oz/mn	cm	"
2,6	38	1,5	22						
3,2	46	2	29	18,4	10.8				
4	58	2,5	36	21,8	12.8	300	10.6	37	14.5
4,5	65	3	44	24,9	14.6	300	10.6	38	14.9
5	73	3,5	51	28,2	16.6	300	10.6	39	15.3

Gun, model FPRO LOCK P LP + HVLP L aircap + hose Ø 8 mm, 7.5 m / 24.6 ft length									
P 0		P 1		Air flow rate		Fluid flow (2)		Fan width (3)	
bar	psi	bar	psi	m3/h	CFM	g/mn	oz/mn	cm	"
2,2	32	1,5	22	16,1	9.4	250	8.8	33	13
3	44	2	29	20,2	11.8	250	8.8	34	13.4
3,5	51	2,5	36	23,5	13.8	250	8.8	35	13.7
4,1	60	3	44	27,2	16				
4,7	68	3,5	51	30,6	18				

Gun, model FPRO LOCK P LP + HVLP XL aircap + hose Ø 8 mm, 7.5 m / 24.6 ft length									
P 0		P 1		Air flow rate		Fluid flow (2)		Fan width (3)	
bar	psi	bar	psi	m3/h	CFM	g/mn	oz/mn	cm	"
2,2	32	1,5	22	16,1	9.4	250	8.8	40	15.7
3	44	2	29	20,2	11.8	250	8.8	41	16.1
3,5	51	2,5	36	23,5	13.8	250	8.8	42	16.5
4,1	60	3	44	27,2	16				
4,7	68	3,5	51	30,6	18				

Gun, model FPRO LOCK P LP + LVLP L aircap + hose Ø 8 mm, 7.5 m / 24.6 ft length									
P 0		P 1		Air flow rate		Fluid flow (2)		Fan width (3)	
bar	psi	bar	psi	m3/h	CFM	g/mn	oz/mn	cm	"
2,2	32	1,5	22	16,1	9.4	250	8.8	33	13
3	44	2	29	20,2	11.8	250	8.8	34	13.4
3,5	51	2,5	36	23,5	13.8	250	8.8	35	13.7
4,1	60	3	44	27,2	16				
4,7	68	3,5	51	30,6	18				

Gun, model FPRO LOCK P LP + LVLP XL aircap + hose Ø 8 mm, 7.5 m / 24.6 ft length									
P 0		P 1		Air flow rate		Fluid flow (2)		Fan width (3)	
bar	psi	bar	psi	m3/h	CFM	g/mn	oz/mn	cm	"
2,2	32	1,5	22	16,1	9.4	250	8.8	40	15.7
3	44	2	29	20,2	11.8	250	8.8	41	16.1
3,5	51	2,5	36	23,5	13.8	250	8.8	42	16.5
4,1	60	3	44	27,2	16				
4,7	68	3,5	51	30,6	18				

Gun, model FPRO LOCK P CONV + CONV L aircap + hose Ø 7 mm, 7.5 m / 24.6 ft length									
P 0		P 1		Air flow rate		Fluid flow (2)		Fan width (3)	
bar	psi	bar	psi	m3/h	CFM	g/mn	oz/mn	cm	"
2,6	38	1,5	22						
3,2	46	2	29	18,4	10.8				
4	58	2,5	36	21,8	12.8	300	10,6	36	14.5
4,5	65	3	44	24,9	14.6	300	10,6	37	14.9
5	73	3,5	51	28,2	16.6	300	10,6	38	15.3



Gun, model FPRO LOCK P CONV + CONV XL aircap + hose Ø 7 mm, 7.5 m / 24.6 ft length									
P 0		P 1		Air flow rate		Fluid flow (2)		Fan width (3)	
bar	psi	bar	psi	m3/h	CFM	g/mn	oz/mn	cm	"
2,6	38	1,5	22						
3,2	46	2	29	18,4	10.8				
4	58	2,5	36	21,8	12.8	300	10,6	45	17.7
4,5	65	3	44	24,9	14.6	300	10,6	46	18.1
5	73	3,5	51	28,2	16.6	300	10,6	47	18.5

(2)	Fluid viscosity : 20 s CA n° 4 (= 40 centipoises)
(3)	Distance gun aircap - surface to be painted : 20 cm

3. INSTALLATION

■ DESCRIPTION OF THE LABEL MARKING

Marking in accordance with the ATEX regulation

SAMES KREMLIN FRANCE	Name and address of the manufacturer	
CE  II 2 G	CE : European conformity  : For use in explosive area II : group II 2 : class 2 G : gas Surface equipment meant to an area where explosive atmospheres due to gas, vapours, mists are liable to appear from time to time in usual operating.	On the body
c T6 X	c : Protection by constructional safety T6 : Temperature class - Maximum surface temperature : 85°C / 185° F X : Special conditions that apply for a safe use. Refer to instructions listed in the instruction manuals accompanying your purchase.	
20xx	Marking of the manufacturing year (with 4 characters)	
FPro Type xx	Gun model	
P air : 6 bar / 87 psi	Gun air supply maximum pressure	

■ INSTALLATION DIAGRAM

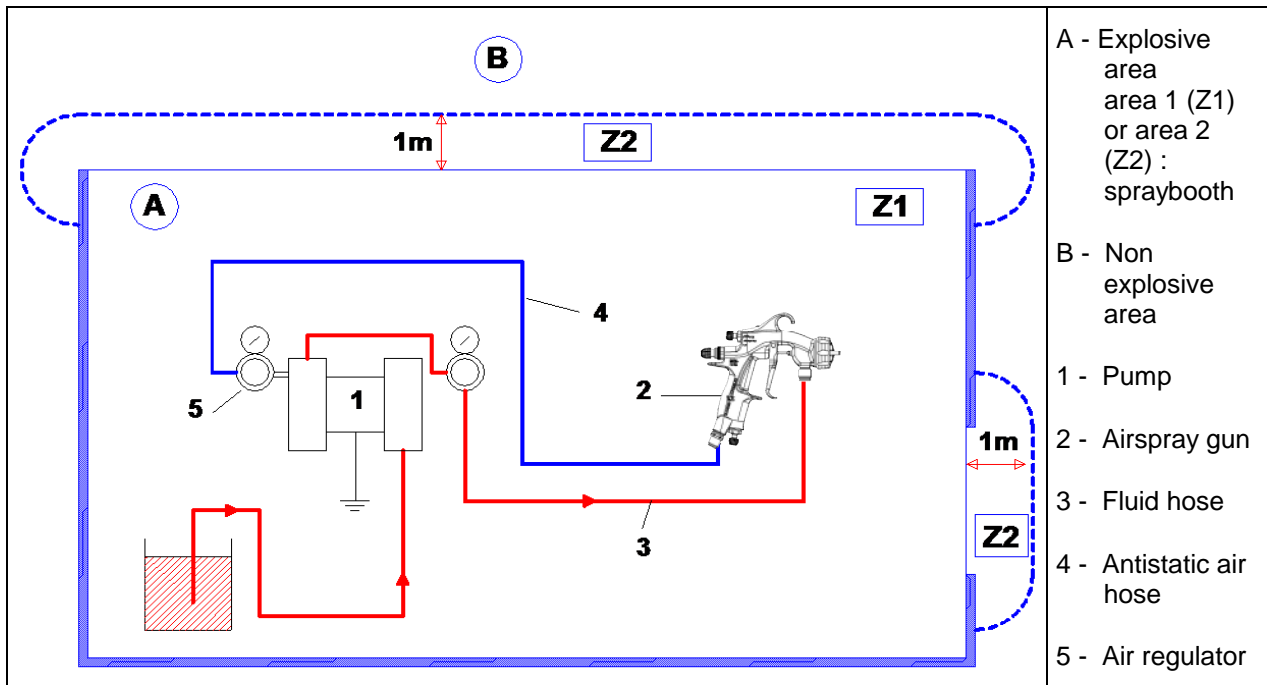

The 1 m / 39.37" distance indicated in the diagram is given for information purposes only and hold harmless to SAMES KREMLIN. The user is responsible for the extraction and conditioning of the painting area where the equipment is used, for working conditions (refer to EN 60079-10 standard).

The 1 m / 39.37" distance may be modified if trials carried out by the user deem this necessary.

- 1 - By means of a grounded air hose, connect the gun to an air regulator that can supply at least 3 bar / 43.5 psi.
- 2 - By means of a fluid hose, connect the gun fluid fitting to the pump. Tighten firmly the fittings.



Nota : In some particular cases, if the air hose (4) is not conductive, the fluid hose (3) must be conductive.

One of the 2 gun hoses (air or fluid) must be conductive.