



DOCUMENTATION - DOKUMENTATION - DOCUMENTACIÓN

PISTOLET MANUEL D'EXTRUSION / EXTRUSION MANUAL SPRAY GUN / MANUELLE
EXTRUSIONSPISTOLE / PISTOLA MANUAL DE EXTRUSIÓN

250 BAR / 3627 PSI

Notice / Manual / Betriebsanleitung : 582.062.110 - 1605

Date / Datum / Fecha : 27/05/16

Annule / Supersede / Ersetzt / Anula :

Modif. / Änderung :

NOTICE ORIGINALE / TRANSLATION FROM THE ORIGINAL MANUAL
/ ÜBERSETZUNG DER ORIGINAL BETRIEBSANLEITUNG
/ TRADUCCIÓN DEL MANUAL ORIGINAL

IMPORTANT : Lire attentivement tous les documents avant le stockage, l'installation ou la mise en service du matériel concerné (à usage strictement professionnel).

Before assembly and start-up, please read and clearly understand all the documents relating to this equipment (professional use only).

WICHTIGER HINWEIS: Vor Lagerung, Installation oder Inbetriebnahme des Geräts bitte sämtliche Dokumente sorgfältig lesen (Einsatz nur von geschultem Personal).

IMPORTANTE : Lea con atención todos los documentos antes de almacenar, instalar o poner en marcha el equipo (uso exclusivamente profesional).

PHOTOS ET ILLUSTRATIONS NON CONTRACTUELLES. MATERIELS SUJETS A MODIFICATION(S) SANS PREAVIS.

THE PICTURES AND DRAWINGS ARE NON CONTRACTUAL. WE RESERVE THE RIGHT TO MAKE CHANGES WITHOUT PRIOR NOTICE.

ALLE IN DIESEM DOKUMENT ENTHALTENEN SCHRIFTLICHEN ANGABEN UND ABBILDUNGEN STELLEN DIE NEUESTEN

PRODUKTINFORMATIONEN DAR. WIR BEHALTEN UNS DAS RECHT VOR, JEDERZEIT OHNE VORANKÜNDIGUNG ÄNDERUNGEN
VORZUNEHMEN.

LAS FOTOGRAFÍAS E ILUSTRACIONES NO SON VINCULANTES. LOS MATERIALES ESTÁN SUJETOS A CAMBIOS SIN PREVIO AVISO.

KREMLIN - REXSON

150, avenue de Stalingrad

93 245 - STAINS CEDEX - France

☎ : 33 (0)1 49 40 25 25 Fax : 33 (0)1 48 26 07 16

www.kremlin-rexson.com



INSTALLATION AND SAFETY INSTRUCTIONS

TRANSLATION OF THE ORIGINAL MANUAL

IMPORTANT : Before assembly and start-up, please read and clearly understand all the documents relating to this equipment (professional use only).

THE PICTURES AND DRAWINGS ARE NON CONTRACTUAL. WE RESERVE THE RIGHT TO MAKE CHANGES WITHOUT PRIOR NOTICE.

KREMLIN - REXSON

150, avenue de Stalingrad

93 245 - STAINS CEDEX – France

☎ : 33 (0)1 49 40 25 25 *Fax* : 33 (0)1 48 26 07 16

www.kremlin-rexson.com

1. SAFETY INSTRUCTIONS

GENERAL SAFETY INSTRUCTIONS



CAUTION : The equipment can be dangerous if you do not follow our instructions concerning installation and servicing described in this manual and in accordance with applicable European standards and local national safety regulations.

Please carefully read all the instruction literature before operating your equipment.

Only trained operators can use the equipment (To acquire an essential training, please contact the "KREMLIN REXSON University" training center - Stains).

The foreman must ensure that the operator has understood the safety instructions for this equipment as well as the instructions in the manuals for the different parts and accessories.

Read carefully all instruction manuals, label markings before operating the equipment.



















Incorrect use may result in injury. This equipment is for professional use only. It must be used only for what it has been designed for. Never modify the equipment. The parts and accessories supplied must be regularly inspected. Defective or worn parts must be replaced.

Guards (motor cover, coupling shields, connectors,...) have been designed for a safe use of the equipment.
The manufacturer will not be held responsible for bodily injury or failure and / or property damage due to destruction, the overshadowing or the partial or total removal of the guards.

Never exceed the equipment components' maximum working pressure.

Comply with regulations concerning safety, fire risks, electrical regulations in force in the country of final destination of the material. Use only products or solvent compatible with the parts in contact with the material (refer to data sheet of the material manufacturer).

PICTOGRAMS

					
NIP HAZARD	WARNING MOVING ELEVATOR	WARNING MOVING PARTS	WARNING MOVING SHOVEL	DO NOT EXCEED THIS PRESSURE	HIGH PRESSURE HAZARD
					
RELIEF OR DRAIN VALVE	WARNING HOSE UNDER PRESSURE	WEAR GLASSES OBLIGATORY	WEAR OF GLOVES IS OBLIGATORY	PRODUCT VAPOR HAZARDS	WARNING HOT PARTS OR AREAS
					
ELECTRICAL HAZARD	WARNING FIRE HAZARDS	EXPLOSION HAZARDS	GROUNDING	WARNING (USER)	WARNING SERIOUS INJURIES

FIRE - EXPLOSION - SPARKS - STATIC ELECTRICITY HAZARDS

A poor earth connection, inadequate ventilation, sparks or static electricity can cause an explosion or fire. to avoid these risks when using or servicing KREMLIN REXSON equipment, the following safety procedures must be followed :



- ensure a good earth connection and ground the parts to be handled i.e. solvents, materials, components and equipment,
- ensure adequate ventilation,
- keep working area clean and free from waste solvents, chemicals, or solid waste i.e. rags, paper and empty chemicals drums,
- never use electrical switches / power if in an atmosphere of volatile solvent vapour,
- stop working immediately in case of electrical arcs,
- never store chemicals and solvents in the working area.
- use paint whose flash point is the highest possible to prevent from any formation of gas and inflammable vapours (refer to materials' safety instructions),
- install a cover on the drums to reduce the diffusion of gas and vapours in the spraybooth.

TOXIC PRODUCT HAZARDS

Toxic products or vapours can cause severe injury not only through contact with the body, but also if the products are ingested or inhaled. It is imperative :



- to know the material products and their risks,
- notified or hazardous materials must be stored in accordance with the regulations,
- the material must be stored in an appropriate container, never place materials in a container where there is a risk of spillage or leakage,
- a procedure must be applied for the safe disposal of waste material. It must comply with all prevailing regulations and legislations of the country where the equipment is to be used,
- protective clothing should always be worn in compliance with the material manufacturers' recommendations,
- depending on the application and chemical safety instructions, safety glasses, hearing protective earplug, gloves, foot wear, protective masks and possible breathing equipment should be worn to comply with the regulations (Refer to chapter "Safety equipment of KREMLIN selection guide).



CAUTION!



It is forbidden to use material containing high concentrations of halogenated hydrocarbon solvents with **aluminium or zinc fillers** .Non-compliance with the instructions may cause explosion risk causing serious or fatal injury.

EQUIPMENT REQUIREMENTS

Guards (motor cover, coupling shields, connectors,...) have been designed for a safe use of the equipment.

The manufacturer will not be held responsible for bodily injury or failure and / or property damage due to destruction, the overshadowing or the partial or total removal of the guards.

PUMP



Before carrying out any work, it is imperative to read and clearly understand the disassembly and reassembly instructions before servicing. The operator must understand the equipment and the safety instructions. These instructions are available in the equipment manuals.



The air motor is designed to be mounted with a pump. Never modify any components or couplings. When operating, please keep hands away from moving parts. Before starting up the equipment, please read the PRESSURE RELIEF instructions. Please ensure that any relief or drain valves fitted are in good working order.

HOSES

- Keep hoses out of circulation areas, moving parts or hot surfaces,
- Never expose product hoses to temperature higher than + 60°C / 140° F or lower than 0°C / 32° F,
- Never pull or use the hoses to move the equipment,
- Tighten all fittings as well as the hoses before operating the equipment,
- Check the hoses regularly; change them if they are damaged,
- Never exceed the working pressure (WP) indicated on the hose.

USED PRODUCTS

Considering the wide variety of products that are available and can be used in our equipment it is impossible to check and make recommendations for all chemical data, regarding the risks of possible chemical attack and their long term chemical reaction

KREMLIN REXSON can not be held liable for :

- Compatibility of wetted parts,
- Risks to staff and the surroundings,
- for worn or defective parts, for faulty equipment or units, or the quality of final product.

It is the responsibility of the user to know and prevent any possible risks such as toxic vapours, fires or explosions. He shall determine the risks of immediate reactions or pursuant to repeated exposures of the staff,

KREMLIN REXSON shall not be liable for physical injuries, direct or indirect material damages caused by the use of chemicals.

2. HANDLING



Check the weight and the dimensions of the equipment

(☞ refer to 'Technical features' section of the instruction manual

If weight and dimensions are too important, the unloading must be carried out by means of a forklift or any other appropriate means with a qualified personnel and in a clear horizontal area to prevent from risks of damage injury or an accident.

The centre of gravity is not in the centre of the machine : carry out by hand a stability-test after having lifted the whole at 10 cm / 3.937" maximum.

After the unloading, the handling of the whole (eg: elevator pump) is carried out by means of a pallet truck taking the bottom part of the frame.

Remark : Each pump motor is fitted with a ring. The ring is designed for the hoisting of one pump and can not be used for the handling of the complete machine.

3. STORING

Storing before installation :

- Storing ambient temperature : 0 / +50 °C / 0 / +122°F
- Protect the whole against dust, water trickling, dampness and shocks.

Storing after installation :

- Operating temperature : +15 / +35 °C / +59 / +138.2° F
- Protect the whole against dust, water trickling, dampness and shocks.

4. INSTALLATION OF THE EQUIPMENT

The machine is installed on a stable horizontal floor (for eg a concrete flag).



To avoid risks caused by static electricity, the equipment as well as its components must be grounded.

- **For the pumping equipments** (pumps, pneumatic rams, frame...), a section wire of 2.5 mm² is fixed on the material. Use this wire to connect the material to "the general ground". In case of severe environments (mechanical protection of the wire of earthing insufficient, vibrations, mobile material...) where function damages at the ground are probable, the user have to replace the provided wire of 2.5 mm² by a device more adapted to its environment (wire with a more important section, bonding strip, fixing by thimble with eyelet...),

The continuity of the ground must be controlled by a qualified electrician. If the continuity of the ground is not ensured, check the terminal, the wire and the earthing point. **Never** use the material without have solved this problem.

- In the severe cases of environments (mechanical protection of the wire of earthing insufficient, vibrations, mobile material...) where damages of the function put at the ground are probable, the user will have to replace the wire of 2.5 mm² provided, by a device more adapted to its environment (wire of more important section, bonding strip, fixing by thimble with eyelet...),
- **The gun** must be 'grounded' via a material hose or an air hose. In case of spraying by means of a gun with cup, the air hose must be conductive,
- **The materials to be painted** must also be grounded.

All the materials situated in the working area shall be grounded.



- **Never store** more than necessary inflammable materials inside the working area,
- The materials must be stored into **approved drums** and grounded,
- Use only grounded **metals containers** for the use of cleaning solvents,
- **Cardboard and paper are prohibited.**

5. MARKING OF THE EQUIPMENT

Each equipment has a marking plate.

The plate consists of the name of the manufacturer, the equipment part number and important information for correct use of the equipment (air pressure, electric power,...).

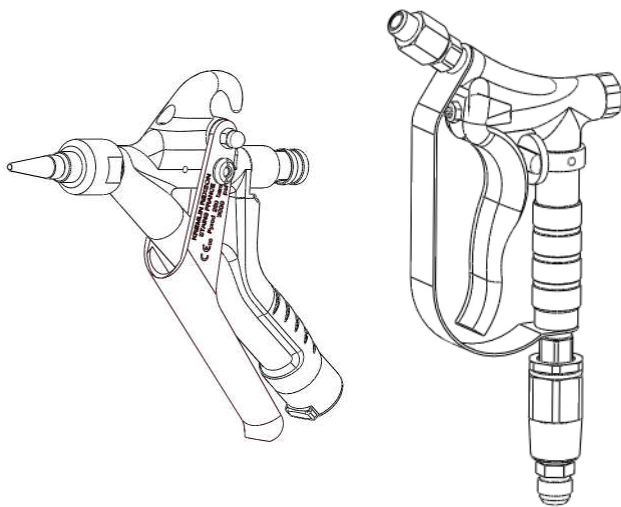

EXTRUSION MANUAL SPRAY GUN

**250 BAR / 3627 PSI
500 BAR / 7251.5 PSI**

Preventive maintenance

TRANSLATION OF THE ORIGINAL MANUAL

IMPORTANT: Before assembly and start-up, please read and clearly understand all the documents relating to the equipment (professional use only).

THE PICTURES AND DRAWINGS ARE NOT CONTRACTUAL. WE RESERVE THE RIGHT TO MAKE CHANGES WITHOUT PRIOR NOTICE.

KREMLIN - REXSON

150, avenue de Stalingrad

93 245 - STAINS CEDEX – France

☎ : 33 (0)1 49 40 25 25 Fax : 33 (0)1 48 26 07 16

www.kremlin-rexson.com



Safety instructions :

- Never try to stop the spray fan with any part of the body (hands, fingers...) or with rags. Never point the spray gun at anyone or at any part of the body.
- The operator will need medical attention if the high pressure material spray is in contact with the the body (eyes, fingers...).
- **Always lock the gun trigger with the safety device when not operating the gun.**
- **Always depressurize air and hoses** before carrying out any servicing on the gun.



In order to protect the operator, protective clothing (gloves, respirator mask, glasses, hearing protective earplug, clothes...) are required.

Use the equipment in a properly ventilated area.

This spray gun is a precision tool. Its correct functioning requires regular maintenance, carried out with care. When it is carried out directly after use, the cleaning of the gun is faster and easier.

For a correct operating of the gun, replace seals every 6 months.

Never use metallic brushes, files or pliers when dismantling the gun.

▪ **SHORT DURATION SHUTDOWN**

Leave the equipment as it is if the material used makes it possible. In any case, if the tip becomes a little clogged with material, it is best to clean it with a brush and some solvent.

▪ **LONG DURATION SHUTDOWN**

Depressurise the material circuits.

Unscrew the tip from the gun, clog it, put it in solvent to soak and then brush it clean.

Use only products or solvent compatible with the parts in contact with the material (refer to data sheet of the material manufacturer).

Flush the installation and leave it purged through with cleaning paste.

➔ **Never soak the gun itself in solvent.**

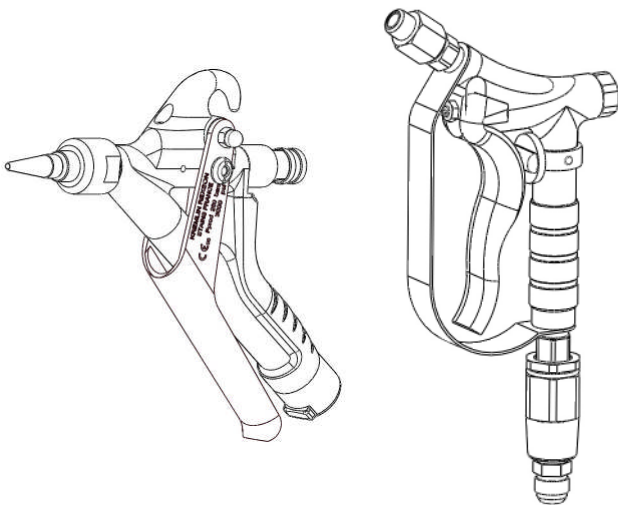

EXTRUSION MANUAL SPRAY GUN

**250 BAR / 3627 PSI
500 BAR / 7251.5 PSI**

Troubleshooting guide

TRANSLATION OF THE ORIGINAL MANUAL

IMPORTANT: Before assembly and start-up, please read and clearly understand all the documents relating to the equipment (professional use only).

THE PICTURES AND DRAWINGS ARE NOT CONTRACTUAL. WE RESERVE THE RIGHT TO MAKE CHANGES WITHOUT PRIOR NOTICE.

KREMLIN - REXSON

150, avenue de Stalingrad

93 245 - STAINS CEDEX – France

☎ : 33 (0)1 49 40 25 25 Fax : 33 (0)1 48 26 07 16

www.kremlin-rexson.com

The extrusion quality depends directly on the shape of the tip. It is recommended to replace it regularly to get a constant fan pattern.

A premature wearing deforms the tip and makes it bigger, thus resulting in higher output.

TROUBLE	CAUSE	SOLUTION
Material is no longer coming out of the gun	Clogged nozzle	Check material supply circuit. Cut the pressure on the pump Remove and clean the nozzle. Depressurise the hoses.
Deformed bead	Nozzle worn	Change it.
Extrusion of intermittent material	Lack of material	Check the material supply.
	Loose elements	Tighten the different elements (nozzle, fittings, etc.)
Fluid leak	Seals missing or damaged	Check the seals, replace if necessary.
	Loose elements	Tighten the different elements (nozzle, fittings, etc.).
Fluid leak in front of the gun	Dirt in the material	Trigger the gun 3 or 4 times or clean the seat.
	Bad tightness between the ball and its seat	Clean the seat or replace the needle assembly (model 250 bar / 3627 psi) / the ball (model 500 bar / 7251.5 psi) and the seat.
	Ball or ball seat misplaced	Replace the needle assembly (model 250 bar / 3627 psi) / the ball (model 500 bar / 7251.5 psi) and the ball seat*.
	Ball or ball seat are dirty	Clean the ball and the ball seat*.
	Worn ball or ball seat	Replace the needle assembly (model 250 bar / 3627 psi) / the ball (model 500 bar / 7251.5 psi) or / and the ball seat*.
Fluid leak around the needle	Worn fluid packing	Clean or replace it.
Fluid leak from the trigger end of the gun	Loose retainer (model 500 bar / 7251.5 psi)	Take out the lever and tighten the retainer (model 500 bar / 7251.5 psi).
	Worn fluid packing	Replace the fluid packing.

*When installing ball and ball seat, make sure that the seat is in line with the parts inside the gun.



**PIECES DE RECHANGE
SPARE PARTS
ERSATZTEILLISTE
PIEZAS DE REPUESTO**

**PISTOLET MANUEL D'EXTRUSION
EXTRUSION MANUAL SPRAY GUN
MANUELLE EXTRUSIONSPISTOLE
PISTOLA MANUAL DE EXTRUSIÓN
250 BAR / 3627 PSI**

NOTICE ORIGINALE
/ TRANSLATION OF THE ORIGINAL MANUAL
/ ÜBERSETZUNG DER ORIGINAL BETRIEBSANLEITUNG
/ TRADUCCIÓN DEL LIBRO ORIGINAL

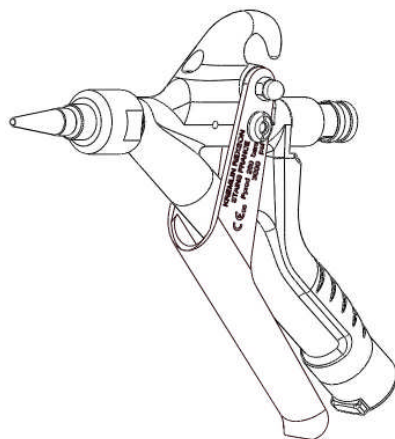

151.110.200

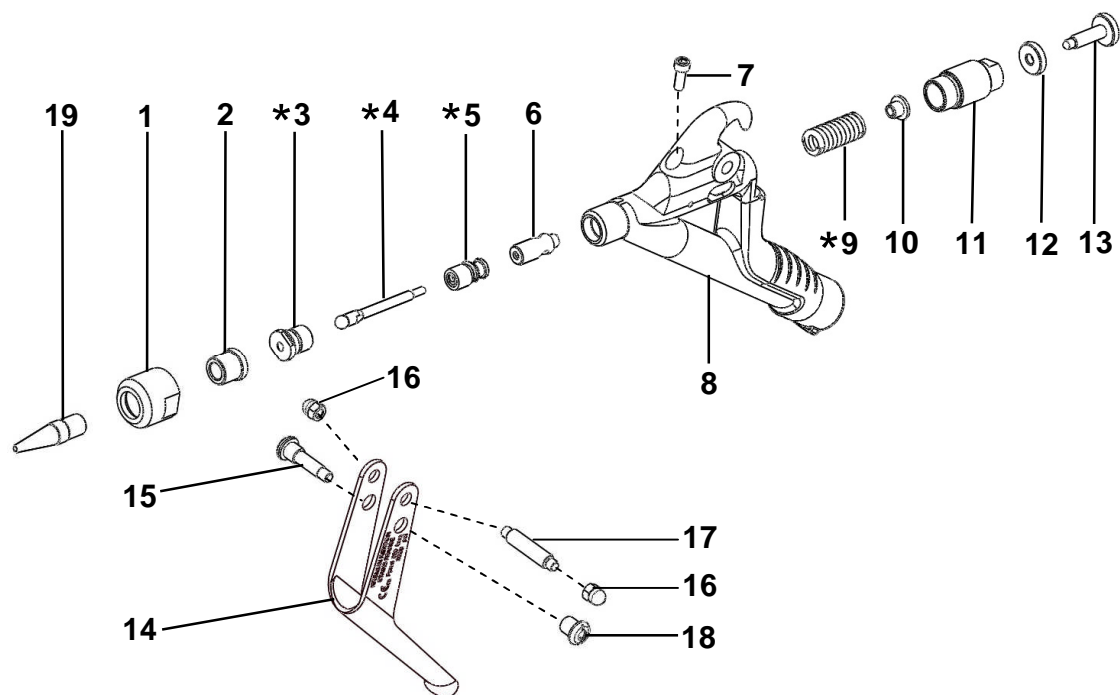

Ind	#	Désignation	Description	Bezeichnung	Denominación	Qté
1	630 417	Ecrou de buse	Nozzle nut	Düsenmutter	Tuerca de boquilla	1
2	630 421	Porte buse	Nozzle holder	Düsenhalterung	Porta-boquilla	1
*3	205 896	Siège	Seat	Sitz	Asiento	1
*4	205 895	Pointeau assemblé	Needle assembly	Farbnadel kpl.	Aguja equipada	1
*5	102 871	Bague de guidage équipée	Guide bush assembly	Führungsbuchse kpl.	Anillo guía equipada	1
6	205 891	Guide pointeau	Needle guide	Nadelführung	Guía aguja	1
7	88 112	Vis	Screw	Schraube	Tornillo	1
8	211 839	Corps	Body	Körper	Cuerpo	1
*9	205 894	Ressort pointeau	Needle spring	Farbnadelfeder	Muelle de aguja	1
10	205 996	Rondelle appui ressort	Spring support washer	Scheibe für Federführung	Arandela apoyo muelle	1
11	205 893	Guide ressort	Spring guide	Federführung	Guía muelle	1
12	204 674	Contre-écrou	Lock nut	Kontermutter	Contra tuerca	1
13	204 673	Vis de réglage	Adjustment screw	Einstellschraube	Tornillo de ajuste	1
14	630 407	Gâchette	Trigger	Abzughebel	Gatillo	1
15	209 990	Axe	Spindle	Achse	Eje	1
16	88 351	Ecrou	Nut	Mutter	Tuerca	2
17	630 449	Axe de poignée	Handle spindle	Griffachse	Eje de empuñadura	1
18	209 991	Ecrou	Nut	Mutter	Tuerca	1
19	151 119 002	Buse Ø 2	Nozzle, model Ø 2	Düse Ø 2	Boquilla, tipo Ø 2	1
*	151 110 690	Kit de maintenance (ind. 3, 4, 5, 9)	Servicing kit (ind. 3, 4, 5, 9)	Servicekit (Pos. 3, 4, 5, 9)	Bolsa de reparación (ind. 3, 4, 5, 9)	1

* Pièces de maintenance préconisées.

* Preceding the index number denotes a suggested spare part.

* Bezeichnete Teile sind empfohlene Ersatzteile.

* Piezas de mantenimiento preventivas.