



DOCUMENTATION - DOKUMENTATION - DOCUMENTACIÓN

PISTOLET / GUN / PISTOLE / PISTOLA

**M22 G**

**PNEUMATIQUE / PNEUMATIC  
PNEUMATISCHE / NEUMÁTICA**

Notice / Manual / Betriebsanleitung : 582.067.110 - 1605

Date / Datum / Fecha : 27/05/16

Annule / Supersede / Ersetzt / Anula :

Modif. / Änderung :

**NOTICE ORIGINALE / TRANSLATION FROM THE ORIGINAL MANUAL  
/ ÜBERSETZUNG DER ORIGINAL BETRIEBSANLEITUNG  
/ TRADUCCIÓN DEL MANUAL ORIGINAL**

**IMPORTANT : Lire attentivement tous les documents avant le stockage, l'installation ou la mise en service du matériel concerné (à usage strictement professionnel).**

**Before assembly and start-up, please read and clearly understand all the documents relating to this equipment (professional use only).**

**WICHTIGER HINWEIS: Vor Lagerung, Installation oder Inbetriebnahme des Geräts bitte sämtliche Dokumente sorgfältig lesen (Einsatz nur von geschultem Personal).**

**IMPORTANTE : Lea con atención todos los documentos antes de almacenar, instalar o poner en marcha el equipo (uso exclusivamente profesional).**

PHOTOS ET ILLUSTRATIONS NON CONTRACTUELLES. MATERIELS SUJETS A MODIFICATION(S) SANS PREAVIS.

THE PICTURES AND DRAWINGS ARE NON CONTRACTUAL. WE RESERVE THE RIGHT TO MAKE CHANGES WITHOUT PRIOR NOTICE.

ALLE IN DIESEM DOKUMENT ENTHALTENEN SCHRIFTLICHEN ANGABEN UND ABBILDUNGEN STELLEN DIE NEUESTEN

PRODUKTINFORMATIONEN DAR. WIR BEHALTEN UNS DAS RECHT VOR, JEDERZEIT OHNE VORANKÜNDIGUNG ÄNDERUNGEN VORZUNEHMEN.

LAS FOTOGRAFÍAS E ILUSTRACIONES NO SON VINCULANTES. LOS MATERIALES ESTÁN SUJETOS A CAMBIOS SIN PREVIO AVISO.

**KREMLIN - REXSON**

150, avenue de Stalingrad

93 245 - STAINS CEDEX - France

☎ : 33 (0)1 49 40 25 25      Fax : 33 (0)1 48 26 07 16

**www.kremlin-rexson.com**



<p align="center"><b>FR</b></p> <p><b><u>Pour une utilisation sûre, il est de votre responsabilité de :</u></b></p> <ul style="list-style-type: none"> <li>• Lire attentivement tous les documents contenus dans le CD joint avant la mise en service de l'équipement,</li> <li>• D'installer, d'utiliser, d'entretenir et de réparer l'équipement conformément aux préconisations de KREMLIN REXSON ainsi qu'aux réglementations nationales et/ou locales,</li> <li>• Vous assurez que les utilisateurs de cet équipement ont été formés, ont parfaitement compris les règles de sécurité et qu'ils les appliquent.</li> </ul>	<p align="center"><b>UK</b></p> <p><b><u>To ensure safe use of the machinery, it is your responsibility to:</u></b></p> <ul style="list-style-type: none"> <li>• Carefully read all documents contained on the enclosed CD before putting the machinery into service,</li> <li>• Install, use, maintain and repair the machinery in accordance with KREMLIN REXSON's recommendations and national and/or local regulations,</li> <li>• Make sure that the users of the machinery have received proper training and that they have perfectly understood the safety rules and apply them.</li> </ul>	<p align="center"><b>DE</b></p> <p><b><u>Eine sichere Nutzung setzt voraus, dass Sie:</u></b></p> <ul style="list-style-type: none"> <li>• alle in der CD enthaltenen Dokumente vor der Inbetriebnahme der Anlage aufmerksam lesen,</li> <li>• die Anlage im Einklang mit den Empfehlungen von KREMLIN REXSON sowie mit den nationalen und/oder lokalen Bestimmungen installieren, verwenden, warten und reparieren,</li> <li>• sich vergewissern, dass die Nutzer dieser Anlage angemessen geschult wurden, die Sicherheitsbestimmungen verstanden haben und sie anwenden.</li> </ul>
<p align="center"><b>ES</b></p> <p><b><u>Para una utilización segura, será de su responsabilidad:</u></b></p> <ul style="list-style-type: none"> <li>• leer atentamente todos los documentos que se incluyen en el CD adjunto antes de la puesta en servicio del equipo,</li> <li>• instalar, utilizar, efectuar el mantenimiento y reparar el equipo con arreglo a las recomendaciones de KREMLIN REXSON y a la normativa nacional y/o local,</li> <li>• cerciorarse de que los usuarios de este equipo han recibido la formación necesaria, han entendido perfectamente las normas de seguridad y las aplican.</li> </ul>	<p align="center"><b>IT</b></p> <p><b><u>Per un uso sicuro, vi invitiamo a:</u></b></p> <ul style="list-style-type: none"> <li>• leggere attentamente tutta la documentazione contenuta nel CD allegato prima della messa in funzione dell'apparecchio,</li> <li>• installare, utilizzare, mantenere e riparare l'apparecchio rispettando le raccomandazioni di KREMLIN REXSON, nonché le normative nazionali e/o locali,</li> <li>• accertarvi che gli utilizzatori dell'apparecchio abbiano ricevuto adeguata formazione, abbiano perfettamente compreso le regole di sicurezza e le applichino.</li> </ul>	<p align="center"><b>PT</b></p> <p><b><u>Para uma utilização segura, é da sua responsabilidade:</u></b></p> <ul style="list-style-type: none"> <li>• Ler atentamente todos os documentos incluídos no CD em anexo antes de pôr o equipamento em funcionamento,</li> <li>• Proceder à instalação, utilização, manutenção e reparação do equipamento de acordo com as preconizações de KREMLIN REXSON, bem como com outros regulamentos nacionais e/ou locais aplicáveis,</li> <li>• Assegurar-se que os utilizadores do equipamento foram devidamente capacitados, compreenderam perfeitamente e aplicam as devidas regras de segurança.</li> </ul>
<p align="center"><b>NL</b></p> <p><b><u>Voor een veilig gebruik dient u:</u></b></p> <ul style="list-style-type: none"> <li>• alle document op de bijgevoegde cd aandachtig te lezen alvorens het apparaat in werking te stellen,</li> <li>• het apparaat te installeren, gebruiken, onderhouden en repareren volgens de door KREMLIN REXSON gegeven aanbevelingen en overeenkomstig de nationale en/of plaatselijke reglementeringen,</li> <li>• zeker te stellen dat de gebruikers van dit apparaat zijn opgeleid, de veiligheidsregels perfect hebben begrepen en dat zij die ook toepassen.</li> </ul>	<p align="center"><b>SE</b></p> <p><b><u>För en säker användning av utrustningen ansvarar ni för följande:</u></b></p> <ul style="list-style-type: none"> <li>• Läs noga samtliga dokument som finns på den medföljande cd-skivan innan utrustningen tas i drift.</li> <li>• Installera, använd, underhåll och reparera utrustningen enligt anvisningarna från KREMLIN REXSON och enligt nationella och/eller lokala bestämmelser.</li> <li>• Försäkra er om att användare av denna utrustning erhållit utbildning, till fullo förstått säkerhetsföreskrifterna och tillämpar dem.</li> </ul>	<p align="center"><b>FI</b></p> <p><b><u>Käytön turvallisuuden varmistamiseksi velvollisuutesi on:</u></b></p> <ul style="list-style-type: none"> <li>• Lukea huolella kaikki CD:llä olevat asiakirjat ennen laitteiston käyttöönottoa,</li> <li>• Noudataa laitteiston asennuksessa, käytössä, kunnossapidossa ja huollossa KREMLIN REXSON in suosituksia sekä kansallisia ja/tai paikallisia määräyksiä,</li> <li>• Varmistaa, että laitteiston käyttäjät ovat koulutettuja ja ymmärtävät täysin turvallisuusmääräykset ja miten niitä sovelletaan.</li> </ul>
<p align="center"><b>PL</b></p> <p><b><u>Dla zapewnienia bezpiecznego użytkowania na użytkownika spoczywa obowiązek:</u></b></p> <ul style="list-style-type: none"> <li>• Uważnego zapoznania się ze wszystkimi dokumentami znajdującymi się na załączonej płycie CD przed pierwszym uruchomieniem urządzenia,</li> <li>• Instalowania, użytkowania, konserwacji i naprawy urządzenia zgodnie z zaleceniami firmy KREMLIN REXSON oraz z przepisami miejscowymi,</li> <li>• Upewnienia, że wszyscy przeszkoleni użytkownicy urządzenia zrozumieli zasady bezpieczeństwa i stosują się do nich.</li> </ul>	<p align="center"><b>CS</b></p> <p><b><u>Pro bezpečné používání jste povinni:</u></b></p> <ul style="list-style-type: none"> <li>• Před uvedením zařízení do provozu si pozorně přečíst veškeré dokumenty obsažené na příloženém CD,</li> <li>• Nainstalovat, používat, udržovat a opravovat zařízení v souladu s pokyny firmy KREMLIN REXSON a s národními a/nebo místními legislativními předpisy,</li> <li>• Ujistit se, že uživatelé tohoto zařízení byli vyškoleni, že dokonale pochopili bezpečnostní pravidla a že je dodržují.</li> </ul>	<p align="center"><b>RU</b></p> <p><b><u>Для целей безопасного использования необходимо:</u></b></p> <ul style="list-style-type: none"> <li>• Ознакомиться со всеми документами, содержащимися в прилагаемом компакт-диске до ввода оборудования в эксплуатацию;</li> <li>• Устанавливать, использовать, производить техническое обслуживание и ремонт оборудования в соответствии с рекомендациями KREMLIN REXSON и национальным и/или местным законодательством;</li> <li>• Убедиться, что пользователи настоящего оборудования прошли подготовку, надлежащим образом усвоили правила безопасности и обеспечивают их соблюдение.</li> </ul>

Déclaration(s) de conformité au verso de ce document / Declaration(s) of conformity at the back of this document / Konformitätserklärung(en) auf der Rückseite dieser Unterlage / Declaración (es) de conformidad en el reverso de este documento / Dichiarazione/i di conformità sul retro del presente documento / Declaração(ões) de conformidade no verso do documento / Conformiteitsverklaring(en) op de keerzijde van dit document / Försäkran om överensstämmelse på omstående sida av detta dokument / Vaatimustenmukaisuusvakuutukset tämän asiakirjan kääntöpuolella / Deklaracja(e) zgodności na odwrocie dokumentu / Prohlášení o shodě se nachází/nacházejí na zadní straně tohoto dokumentu / Сертификат(ы) соответствия расположены на оборотной стороне настоящего документа

**VALABLE JUSQU'AU 19 AVRIL 2016**  
**VALID UNTIL 19 APRIL 2016**  
**GÜLTIG BIS ZUM 19. APRIL 2016**  
**VALIDEZ HASTA EL 19 DE ABRIL DE 2016**  
**VALIDO FINO AL 19 APRILE 2016**  
**APLICÁVEL ATÉ 19 DE ABRIL DE 2016**  
**GELDIG TOT 19 APRIL 2016**  
**GÄLLER TILL OCH MED DEN 19 APRIL 2016**  
**VOIMASSA 19.4.2016 SAAKKA**  
**WAŻNOŚĆ DO 19 KWIETNIA 2016 R.**  
**PLATÍ DO 19. DUBNA 2016**  
**ДЕЙСТВИТЕЛЬНО ДО 19 АПРЕЛЯ 2016 ГОДА**



**DECLARATION CE DE CONFORMITE**  
**EC DECLARATION OF CONFORMITY**  
**EG KONFORMITÄTSERKLÄRUNG**  
**DECLARACIÓN CE DE CONFORMIDAD**  
**DICHIARAZIONE CE DI CONFORMITÀ**  
**DECLARAÇÃO CE DE CONFORMIDADE EG-**  
**VERKLARING VAN OVEREENSTEMMING**  
**EG-FÖRSÄKRAN OM ÖVERENSSTÄMMELSE**  
**EY-VAATIMUKSEN MUKAISUUSVAKUUTUS**  
**DEKLARACJA ZGODNOŚCI CE**  
**CE PROHLÁŠENÍ O SHODĚ**  
**ДЕКЛАРАЦИЯ СООТВЕТСТВИЯ CE**

Le fabricant / The manufacturer / Der Hersteller / El fabricante / Il produttore / O fabricante / De fabrikant / Tillverkare / Valmistaja / Producent / Výrobce / Изготовитель:	<b>KREMLIN REXSON</b> 150, avenue de Stalingrad 93 240 - STAINS - FRANCE Tél. 33 (0)1 49 40 25 25 - Fax : 33 (0)1 48 26 07 16
------------------------------------------------------------------------------------------------------------------------------------------------------------------------------------------	----------------------------------------------------------------------------------------------------------------------------------------

Déclare que le matériel désigné ci-après / Herewith declares that the equipment / erklärt hiermit, dass die / Declara que el material designado a continuación / Dichiaro che il materiale sottoindicato / Declara que o material a seguir designado / verklaart dat de hieronder aangeduide apparatuur / Kungör att den utrustning som anges här nedan / ilmoittaa, että alla mainitut laitteistot / Oświadcza, że wymienione poniżej urządzenia / Prohlašuje, že níže uvedené vybavení / Декларирует, что нижеуказанное оборудование:

**PISTOLETS MANUELS DE PULVERISATION PNEUMATIQUES / AIRSPRAY MANUAL SPRAYING GUNS**  
**/ LUFTZERSTÄUBENDE HAND-SPRITPISTOLEN / PISTOLAS MANUALES DE PULVERIZACIÓN NEUMÁTICAS**

M 22	G	A	P
	M 22 G HTI		M 22 P HTI
	M 22 G HPA	M 22 A HPA	M 22 P HPA
	M 22 G HPA GSP		M 22 P HTV
	M 22 G BASIK HPA	M 22 A BASIK HPA	M 22 P BASIK HPA
			M 22 P WBE HPA
S 3	G	A	P
	S 3 HTI		S 3 P HTI
	S 3 G HPA	S 3 A HPA	S 3 P HPA

Est conforme à la législation d'harmonisation de l'Union applicable suivante / Is in conformity with the relevant Union harmonisation legislation / Erfüllt die einschlägigen Harmonisierungsrechtsvorschriften der Union / es conforme con la legislación de armonización pertinente de la Unión / è conforme alla pertinente normativa di armonizzazione dell'Unione / in overeenstemming met de desbetteffende harmonisatiewetgeving van de Unie / med den relevanta harmoniserade unionslagstiftningen / on asiaa koskevan unionin yhdenmukaistamislainsäädännön vaatimusten mukainen / jest zgodny z odpowiednimi wymaganiami unijnego prawodawstwa harmonizacyjnego / Shoduje se s následující příslušnou evropskou harmonizační legislativou / Соответствует следующим стандартизированным нормам Союза

Directive ATEX / ATEX Directive / ATEX Richtlinie / Directiva ATEX / Direttiva ATEX / Diretiva ATEX / ATEX-Richtijn / ATEX-direktivet / ATEX-direktivi / Dyrektywa ATEX / Směrnice ATEX / Директива ATEX	<b>94/9/CE</b>
-------------------------------------------------------------------------------------------------------------------------------------------------------------------------------------------------------------	----------------



Dominique LAGOUGE

Directeur Général / Chief Executive Officer / Generaldirektor  
 / Director General / Direttore Generale / Director Geral / Algemeen  
 Directeur / Generaldirektör / Pääjohtaja / Dyrektor Naczelny  
 / Dyrektor Generalny / Generální ředitel / Генеральный директор

Fait à Stains, le / Established in Stains, on / Geschehen zu Stains, am / En Stains, a / Redatto a Stains, / Vastgesteld te Stains, / Ufformat i Stains, den / Stains, Ranska, / Sporządzono w Stains, dnia / Stains, dnia / Издано в г. Стен (Stains) 10/07/2014 - 07/10/2014

**VALABLE A PARTIR DU 20 AVRIL 2016**  
**VALID FROM 20 APRIL 2016**  
**GÜLTIG AB DEM 20. APRIL 2016**  
**VALIDEZ A PARTIR DEL 20 DE ABRIL DE 2016**  
**VALIDO A PARTIRE DAL 20 APRILE 2016**  
**APLICÁVEL A PARTIR DE 20 DE ABRIL DE 2016**  
**GELDIG VANAF 20 APRIL 2016.**  
**GÄLLER FRÅN OCH MED DEN 20 APRIL 2016**  
**VOIMASSA 20.4.2016 ALKAEN**  
**WAŻNOŚĆ OD 20 KWIETNIA 2016 R.**  
**PLATÍ OD 20. DUBNA 2016**  
**ДЕЙСТВТЕЛЬНО С 20 АПРЕЛЯ 2016 ГОДА**



**DECLARATION UE DE CONFORMITE**  
**UE DECLARATION OF CONFORMITY**  
**EU-KONFORMITÄTSEKTLÄRUNG**  
**DECLARACIÓN UE DE CONFORMIDAD**  
**DICHIARAZIONE DI CONFORMITÀ UE**  
**DECLARAÇÃO UE DE CONFORMIDADE**  
**EU-KONFORMITEITSVERKLARING**  
**EU-FÖRSÄKRAN OM ÖVERENSSTÄMMELSE**  
**EU-VAATIMUKSEN MUKAISUUSVAKUUTUS**  
**DEKLARACJA ZGODNOŚCI UE**  
**EU PROHLÁŠENÍ O SHODĚ**  
**ДЕКЛАРАЦИЯ О СООТВЕТСТВИИ НОРМАМ ЕС**

Le fabricant / The manufacturer / Der Hersteller / El fabricante / Il produttore / O fabricante / De fabrikant / Tillverkare / Valmistaja / Producent / Výrobce / Изготовитель:	<b>KREMLIN REXSON</b> 150, avenue de Stalingrad 93 240 - STAINS - FRANCE Tél. 33 (0)1 49 40 25 25 - Fax : 33 (0)1 48 26 07 16
------------------------------------------------------------------------------------------------------------------------------------------------------------------------------------------	----------------------------------------------------------------------------------------------------------------------------------------

Déclare que le matériel désigné ci-après / Herewith declares that the equipment / erklärt hiermit, dass die / Declara que el material designado a continuación / Dichiaro che il materiale sottoindicato / Declara que o material a seguir designado / verklaart dat de hieronder aangeduide apparatuur / Kungör att den utrustning som anges här nedan / ilmoittaa, että alla mainitut laitteistot / Oświadczam, że wymienione poniżej urządzenia / Prohlašuje, že níže uvedené vybavení / Декларирует, что ниженазванное оборудование:

**PISTOLETS MANUELS DE PULVERISATION PNEUMATIQUES / AIRSPRAY MANUAL SPRAYING GUNS**  
**/ LUFTZERSTÄUBENDE HAND-SPRITPISTOLEN / PISTOLAS MANUALES DE PULVERIZACIÓN NEUMÁTICAS**

M 22	G	A	P
	M 22 G HTI		M 22 P HTI
	M 22 G HPA	M 22 A HPA	M 22 P HPA
	M 22 G HPA GSP		M 22 P HTV
	M 22 G BASIK HPA	M 22 A BASIK HPA	M 22 P BASIK HPA
			M 22 P WBE HPA
S 3	G	A	P
	S 3 HTI		S 3 P HTI
	S 3 G HPA	S 3 A HPA	S 3 P HPA

Est conforme à la législation d'harmonisation de l'Union applicable suivante / Is in conformity with the relevant Union harmonisation legislation / Erfüllt die einschlägigen Harmonisierungsrechtsvorschriften der Union / es conforme con la legislación de armonización pertinente de la Unión / è conforme alla pertinente normativa di armonizzazione dell'Unione / in overeenstemming met de desbetteffende harmonisatiewetgeving van de Unie / med den relevanta harmoniserade unionslagstiftningen / on asiaa koskevan unionin yhdenmukaistamislainsäädännön vaatimusten mukainen / jest zgodny z odpowiednimi wymaganiami unijnego prawodawstwa harmonizacyjnego / Shoduje se s následující příslušnou evropskou harmonizační legislativou / Соответствует следующим стандартизированным нормам Союза

Directive ATEX / ATEX Directive / ATEX Richtlinie / Directiva ATEX / Direttiva ATEX / Diretiva ATEX / ATEX-Richtlijn / ATEX-direktivet / ATEX-direktivi / Dyrektywa ATEX / Směrnice ATEX / Директива ATEX 	<b>2014/34/UE</b>
Procédure d'évaluation de la conformité : Module A Documentation technique (Annexe VIII) archivée par : / Conformity assessment procedure: Module A Technical documentation (ANNEX VIII) recorded by: / Verfahren zur Konformitätsbewertung: Modul A Technische Unterlagen (ANLAGE VIII) archiviert durch: / Procedimiento de evaluación de la conformidad: Módulo A Documentación técnica (ALLEGATO VIII) archiviata a cura di: / Procedimento de avaliação da conformidade: Módulo A Documentação técnica (ANEXO VIII) arquivada por: / Conformiteitsbeoordelingsprocedure: Module A Technische documentatie (BIJLAGE VIII) gearhiveerd door: / Förfarande för bedömning av överensstämmelse: Modul A Teknisk dokumentation (BILAGA VIII) arkiverad av: / Vaatimusten mukaisuusarviointimenetelmä: moduuli A Tekninen dokumentaatio (LIITE VIII) arkistoitu: / Procedura oceny zgodności: Moduł A Dokumentacji technicznej (ZAŁĄCZNIK VIII) zarchiwizowane przez: / Postup posuzování shody: Modul A Technická dokumentace (PŘÍLOHA VIII) archivována: / Процедура оценки соответствия: Модуль А Техническая документация (ПРИЛОЖЕНИЕ VIII), архивированная: ISSeP Zoning A. Schweitzer Rue de la Platinerie B - 7340 COLFONTAINE BELGIQUE	

Dominique LAGOUGE

Directeur Général / Chief Executive Officer / Generaldirektor  
 / Director General / Direttore Generale / Director Geral / Algemeen  
 Directeur / Generaldirektör / Pääjohtaja / Dyrektor Naczelny  
 / Dyrektor Generalny / Generální ředitel / Генеральный директор

Fait à Stains, le / Established in Stains, on / Geschehen zu Stains, am / En Stains, a / Redatto a Stains, / Vastgesteld te Stains, / Utformat i Stains, den / Stains, Ranska, / Sporządzono w Stains, dnia / Stains, dnia / Издано в г. Стен (Stains) 29/03/2016 - 03/29/2016



# INSTALLATION AND SAFETY INSTRUCTIONS

## TRANSLATION OF THE ORIGINAL MANUAL

**IMPORTANT** : Before assembly and start-up, please read and clearly understand all the documents relating to this equipment (professional use only).

*THE PICTURES AND DRAWINGS ARE NON CONTRACTUAL. WE RESERVE THE RIGHT TO MAKE CHANGES WITHOUT PRIOR NOTICE.*

### **KREMLIN - REXSON**

150, avenue de Stalingrad

93 245 - STAINS CEDEX – France

**☎** : 33 (0)1 49 40 25 25      *Fax* : 33 (0)1 48 26 07 16

**[www.kremlin-rexson.com](http://www.kremlin-rexson.com)**

# 1. SAFETY INSTRUCTIONS

## GENERAL SAFETY INSTRUCTIONS



**CAUTION** : The equipment can be dangerous if you do not follow our instructions concerning installation and servicing described in this manual and in accordance with applicable European standards and local national safety regulations.

Please carefully read all the instruction literature before operating your equipment.

**Only trained operators can use the equipment** (To acquire an essential training, please contact the "KREMLIN REXSON University" training center - Stains).

The foreman must ensure that the operator has understood the safety instructions for this equipment as well as the instructions in the manuals for the different parts and accessories.

Read carefully all instruction manuals, label markings before operating the equipment.



















Incorrect use may result in injury. This equipment is for professional use only. It must be used only for what it has been designed for. Never modify the equipment. The parts and accessories supplied must be regularly inspected. Defective or worn parts must be replaced.

**Guards (motor cover, coupling shields, connectors,...) have been designed for a safe use of the equipment.**  
**The manufacturer will not be held responsible for bodily injury or failure and / or property damage due to destruction, the overshadowing or the partial or total removal of the guards.**

**Never exceed the equipment components' maximum working pressure.**

Comply with regulations concerning safety, fire risks, electrical regulations in force in the country of final destination of the material. Use only products or solvent compatible with the parts in contact with the material (refer to data sheet of the material manufacturer).

## PICTOGRAMS

					
NIP HAZARD	WARNING MOVING ELEVATOR	WARNING MOVING PARTS	WARNING MOVING SHOVEL	DO NOT EXCEED THIS PRESSURE	HIGH PRESSURE HAZARD
					
RELIEF OR DRAIN VALVE	WARNING HOSE UNDER PRESSURE	WEAR GLASSES OBLIGATORY	WEAR OF GLOVES IS OBLIGATORY	PRODUCT VAPOR HAZARDS	WARNING HOT PARTS OR AREAS
					
ELECTRICAL HAZARD	WARNING FIRE HAZARDS	EXPLOSION HAZARDS	GROUNDING	WARNING (USER)	WARNING SERIOUS INJURIES

## FIRE - EXPLOSION - SPARKS - STATIC ELECTRICITY HAZARDS

A poor earth connection, inadequate ventilation, sparks or static electricity can cause an explosion or fire. to avoid these risks when using or servicing KREMLIN REXSON equipment, the following safety procedures must be followed :



- ensure a good earth connection and ground the parts to be handled i.e. solvents, materials, components and equipment,
- ensure adequate ventilation,
- keep working area clean and free from waste solvents, chemicals, or solid waste i.e. rags, paper and empty chemicals drums,
- never use electrical switches / power if in an atmosphere of volatile solvent vapour,
- stop working immediately in case of electrical arcs,
- never store chemicals and solvents in the working area.
- use paint whose flash point is the highest possible to prevent from any formation of gas and inflammable vapours (refer to materials' safety instructions),
- install a cover on the drums to reduce the diffusion of gas and vapours in the spraybooth.

## TOXIC PRODUCT HAZARDS

Toxic products or vapours can cause severe injury not only through contact with the body, but also if the products are ingested or inhaled. It is imperative :



- to know the material products and their risks,
- notified or hazardous materials must be stored in accordance with the regulations,
- the material must be stored in an appropriate container, never place materials in a container where there is a risk of spillage or leakage,
- a procedure must be applied for the safe disposal of waste material. It must comply with all prevailing regulations and legislations of the country where the equipment is to be used,
- protective clothing should always be worn in compliance with the material manufacturers' recommendations,
- depending on the application and chemical safety instructions, safety glasses, hearing protective earplug, gloves, foot wear, protective masks and possible breathing equipment should be worn to comply with the regulations (Refer to chapter "Safety equipment of KREMLIN selection guide).



### **CAUTION!**



It is forbidden to use material containing high concentrations of halogenated hydrocarbon solvents with **aluminium or zinc fillers** .Non-compliance with the instructions may cause explosion risk causing serious or fatal injury.

## **EQUIPMENT REQUIREMENTS**

**Guards (motor cover, coupling shields, connectors,...) have been designed for a safe use of the equipment.**

**The manufacturer will not be held responsible for bodily injury or failure and / or property damage due to destruction, the overshadowing or the partial or total removal of the guards.**

### **PUMP**



Before carrying out any work, it is imperative to read and clearly understand the disassembly and reassembly instructions before servicing. The operator must understand the equipment and the safety instructions. These instructions are available in the equipment manuals.



The air motor is designed to be mounted with a pump. Never modify any components or couplings. When operating, please keep hands away from moving parts. Before starting up the equipment, please read the PRESSURE RELIEF instructions. Please ensure that any relief or drain valves fitted are in good working order.

### **HOSES**

- Keep hoses out of circulation areas, moving parts or hot surfaces,
- Never expose product hoses to temperature higher than + 60°C / 140° F or lower than 0°C / 32° F,
- Never pull or use the hoses to move the equipment,
- Tighten all fittings as well as the hoses before operating the equipment,
- Check the hoses regularly; change them if they are damaged,
- Never exceed the working pressure (WP) indicated on the hose.

## **USED PRODUCTS**

Considering the wide variety of products that are available and can be used in our equipment it is impossible to check and make recommendations for all chemical data, regarding the risks of possible chemical attack and their long term chemical reaction

KREMLIN REXSON can not be held liable for :

- Compatibility of wetted parts,
- Risks to staff and the surroundings,
- for worn or defective parts, for faulty equipment or units, or the quality of final product.

It is the responsibility of the user to know and prevent any possible risks such as toxic vapours, fires or explosions. He shall determine the risks of immediate reactions or pursuant to repeated exposures of the staff,

KREMLIN REXSON shall not be liable for physical injuries, direct or indirect material damages caused by the use of chemicals.



## 2. HANDLING



### **Check the weight and the dimensions of the equipment**

**(☞ refer to 'Technical features' section of the instruction manual**

If weight and dimensions are too important, the unloading must be carried out by means of a forklift or any other appropriate means with a qualified personnel and in a clear horizontal area to prevent from risks of damage injury or an accident.

The centre of gravity is not in the centre of the machine : carry out by hand a stability-test after having lifted the whole at 10 cm / 3.937" maximum.

After the unloading, the handling of the whole (eg: elevator pump) is carried out by means of a pallet truck taking the bottom part of the frame.

**Remark : Each pump motor is fitted with a ring. The ring is designed for the hoisting of one pump and can not be used for the handling of the complete machine.**

## 3. STORING

Storing before installation :

- Storing ambient temperature : 0 / +50 °C / 0 / +122°F
- Protect the whole against dust, water trickling, dampness and shocks.

Storing after installation :

- Operating temperature : +15 / +35 °C / +59 / +138.2° F
- Protect the whole against dust, water trickling, dampness and shocks.

## 4. INSTALLATION OF THE EQUIPMENT

The machine is installed on a stable horizontal floor (for eg a concrete flag).



**To avoid risks caused by static electricity, the equipment as well as its components must be grounded.**

- **For the pumping equipments** (pumps, pneumatic rams, frame...), a section wire of 2.5 mm<sup>2</sup> is fixed on the material. Use this wire to connect the material to "the general ground". In case of severe environments (mechanical protection of the wire of earthing insufficient, vibrations, mobile material...) where function damages at the ground are probable, the user have to replace the provided wire of 2.5 mm<sup>2</sup> by a device more adapted to its environment (wire with a more important section, bonding strip, fixing by thimble with eyelet...),

The continuity of the ground must be controlled by a qualified electrician. If the continuity of the ground is not ensured, check the terminal, the wire and the earthing point. **Never** use the material without have solved this problem.

- In the severe cases of environments (mechanical protection of the wire of earthing insufficient, vibrations, mobile material...) where damages of the function put at the ground are probable, the user will have to replace the wire of 2.5 mm<sup>2</sup> provided, by a device more adapted to its environment (wire of more important section, bonding strip, fixing by thimble with eyelet...),
- **The gun** must be 'grounded' via a material hose or an air hose. In case of spraying by means of a gun with cup, the air hose must be conductive,
- **The materials to be painted** must also be grounded.

**All the materials situated in the working area shall be grounded.**



- **Never store** more than necessary inflammable materials inside the working area,
- The materials must be stored into **approved drums** and grounded,
- Use only grounded **metals containers** for the use of cleaning solvents,
- **Cardboard and paper are prohibited.**





## 5. MARKING OF THE EQUIPMENT



Each equipment has a marking plate.



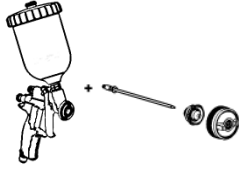
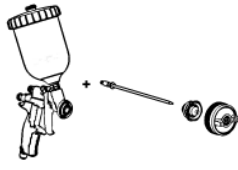

The plate consists of the name of the manufacturer, the equipment part number and important information for correct use of the equipment (air pressure, electric power,...).

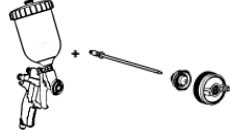

# PIECES DE RECHANGE SPARE PARTS ERSATZTEILLISTE PIEZAS DE REPUESTO

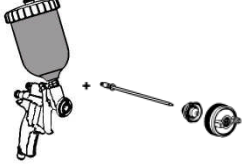
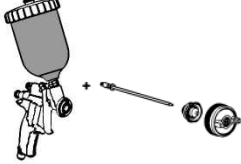

## M 22 G HTI - HPA - GSP (HPA)

M 22 G HTi (K HVLP)			M 22 G HTi		
					
		#			#
	-	136.130.100		-	136.130.100
	+ 12 E5 KHVLP	136.130.101		+ 12 EP 5	136.130.111
	+ 13 E5 KHVLP	136.130.102		+ 13 EP 5	136.130.112
	+ 14 E5 KHVLP	136.130.103		+ 14 EP 5	136.130.113
	+ 15 E5 KHVLP	136.130.104		+ 15 EP 5	136.130.114
	+ 18 E5 KHVLP	136.130.105		+ 18 EP 5	136.130.115
	+ 22 E5 KHVLP	136.130.106		+ 22 EP 5	136.130.116

M 22 G HPA		
		
		#
	-	136.135.100
	+ 12 EN 5	136.135.101
	+ 13 EN 5	136.135.102
	+ 14 EN 5	136.135.103
	+ 15 EN 5	136.135.104
	+ 18 EN 5	136.135.105
	+ 22 EN 5	136.135.106

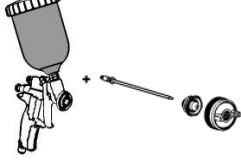
M 22 G HTi (K HVLP)			M 22 G HTi		
					
		#			#
	-	136.131.100		-	136.131.100
	+ 12 E5 KHVLP	136.132.107 (0,25 l)		-	-
	+ 12 E5 KHVLP	136.131.101		+ 12 EP 5	136.131.111
	+ 13 E5 KHVLP	136.131.102		+ 13 EP 5	136.131.112
	+ 14 E5 KHVLP	136.131.103		+ 14 EP 5	136.131.113
	+ 15 E5 KHVLP	136.131.104		+ 15 EP 5	136.131.114
	+ 18 E5 KHVLP	136.131.105		+ 18 EP 5	136.131.115
	+ 22 E5 KHVLP	136.131.106		+ 22 EP 5	136.131.116

M 22 G HPA		
		
		#
	-	136.136.100
	+ 12 EN 5	136.136.101
	+ 13 EN 5	136.136.102
	+ 14 EN 5	136.136.103
	+ 15 EN 5	136.136.104
	+ 18 EN 5	136.136.105
	+ 22 EN 5	136.136.106

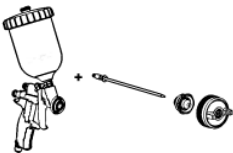
M 22 GSP		
		
		#
	-	136.138.100
	+ 15 EN 5	136.138.104
	+ 18 EN 5	136.138.105
	+ 22 EN 5	136.138.106

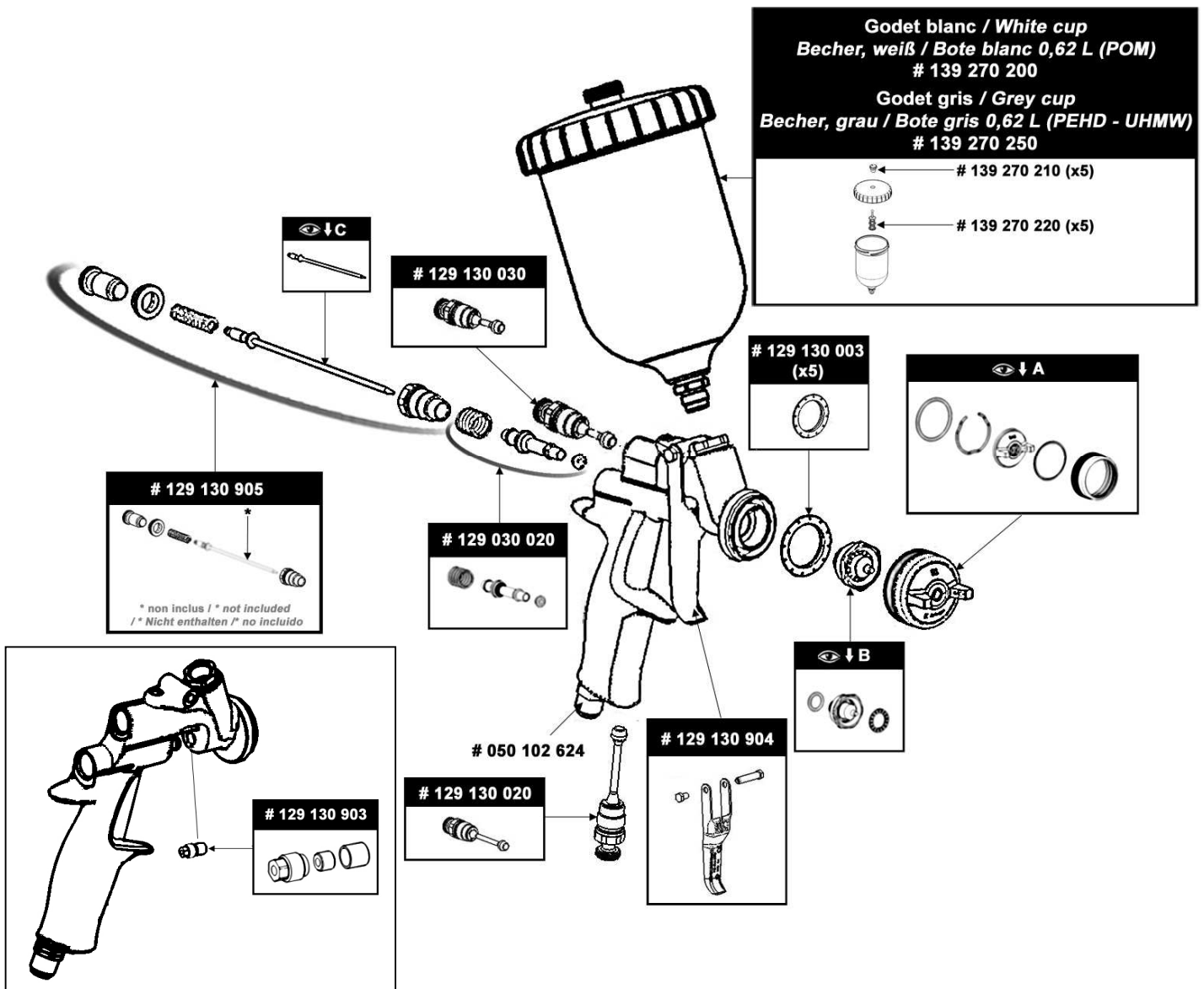

# M 22 GSP (HPA)

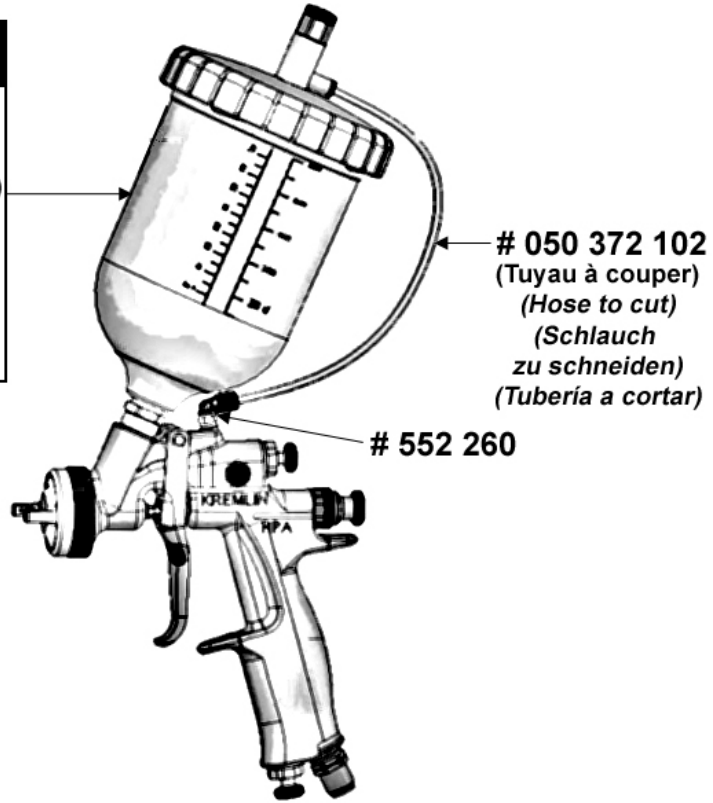
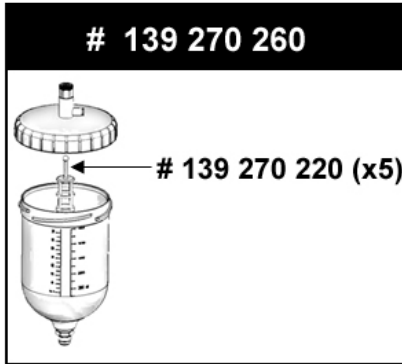

**Pochette de maintenance / Servicing kit**  
**Reparaturatz / Bolsa de reparación**  
**# 129 140 901**  
( < année / year / jahr / año 2009 )



**Pochette de joints / Seal kit**  
**Dichtungssatz / Bolsa de juntas**  
**# 129 130 901**

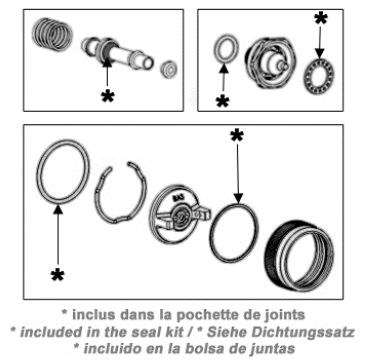





**Pochette de maintenance / Servicing kit**  
**Reparaturatz / Bolsa de reparación**  
**# 129 130 902**

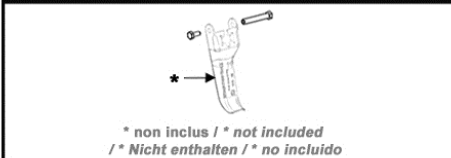

**Pochette de maintenance / Servicing kit**  
**Reparaturatz / Bolsa de reparación**  
**# 129 140 904**



		A		B		C	
	#		#		#		#

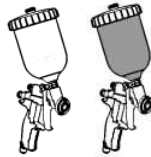

9 E 5 K HVLP	031.130.007	E 5 K HVLP	132.130.100	9	134.130.200	07 - 09 - 12 - 13	033.130.100
12 E 5 K HVLP	031.130.001			12	134.130.300		
13 E 5 K HVLP	031.130.002			13	134.130.400		
14 E 5 K HVLP	031.130.003			14	134.130.500	14 - 15 - 18	033.130.200
15 E 5 K HVLP	031.130.004			15	134.130.600		
18 E 5 K HVLP	031.130.005			18	134.130.700		
22 E 5 K HVLP	031.130.006			22	134.130.800	22 - 27	033.130.300

12 EP 5	031.130.011	EP 5	132.130.300	12	134.130.300	07 - 09 - 12 - 13	033.130.100
13 EP 5	031.130.012			13	134.130.400		
14 EP 5	031.130.013			14	134.130.500	14 - 15 - 18	033.130.200
15 EP 5	031.130.014			15	134.130.600		
18 EP 5	031.130.015			18	134.130.700		
22 EP 5	031.130.016			22	134.130.800	22 - 27	033.130.300

12 EN 5	031.135.001	EN 5	132.130.200	12	134.130.300	07 - 09 - 12 - 13	033.130.100
13 EN 5	031.135.002			13	134.130.400		
14 EN 5	031.135.003			14	134.130.500	14 - 15 - 18	033.130.200
15 EN 5	031.135.004			15	134.130.600		
18 EN 5	031.135.005			18	134.130.700		
22 EN 5	031.135.006			22	134.130.800	22 - 27	033.130.300



15 EN 5	031.135.004	EN 5	132.130.200	15	134.130.600	14 - 15 - 18	033.130.200
18 EN 5	031.135.005			18	134.130.700		
22 EN 5	031.135.006			22	134.130.800	22 - 27	033.130.300

# 049 030 042



# 906 300 101



**Godet gris / Grey cup**  
**Becher, grau / Bote gris (0,25l)**  
# 139 280 250

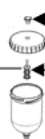

# 139 270 210 (x5)

# 139 270 220 (x5)

**Manomètre à la crosse / Handle gauge**  
**Manometer für den Griff**  
**Manómetro a la empuñadura**  
# 150 070 560



# 049 221 900



# 049 221 800

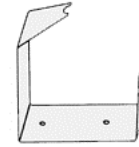

**M 22 G HTi - M 22 G HPA**

**Pointeau avec embout en résine acétale**  
**Needle with polyacetal needle-end**  
**Nadel mit Nadelspitze in Polyacetal**  
**Aguja con punta en resina de acetato**



# 033 130 400 (07P - 09P - 12P - 13P)

# 033 130 500 (14P - 15P - 18P)

# 033 130 300 (22 -27)

# 129 140 092 (x5) (07P - 09P - 12P - 13P)

# 129 140 093 (x5) (14P - 15P - 18P)

# 129 140 090 (x5) (22 -27)



# ENTRETIEN PREVENTIF PREVENTIVE MAINTENANCE VORBEUGENDE WARTUNG MANTENIMIENTO PREVENTIVO

## PISTOLET PNEUMATIQUE MANUEL / MANUAL AIRSPRAY GUN / HAND LUFTSPRITZPISTOLE / PISTOLA NEUMÁTICA MANUAL

AVANT CHAQUE OPERATION DE MAINTENANCE / DO THIS BEFORE ANY MAINTENANCE ACTION  
VOR JEDER WARTUNGSARBEIT IST FOLGENDES ZU TUN / ANTES DE CADA OPERACIÓN DE MANTENIMIENTO

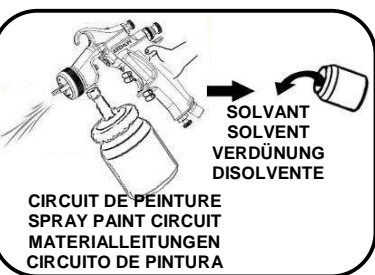
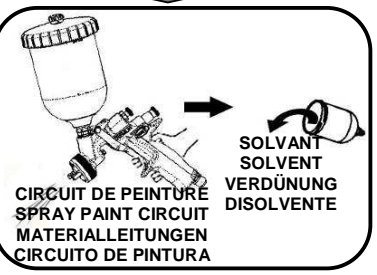
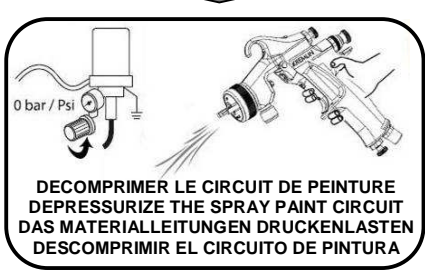
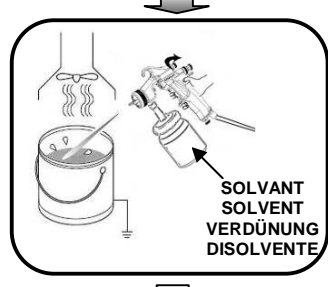
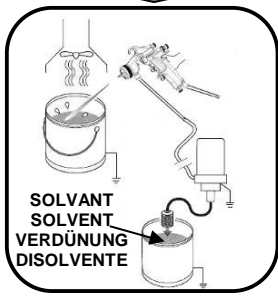
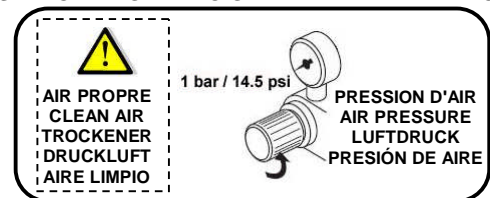
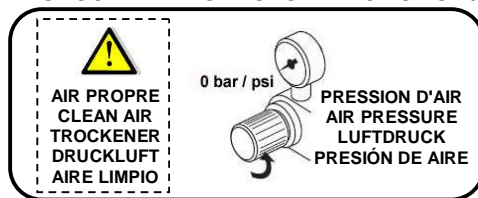

TOUS LES JOURS / DAILY TASKS/ TÄGLICH / DIARIO

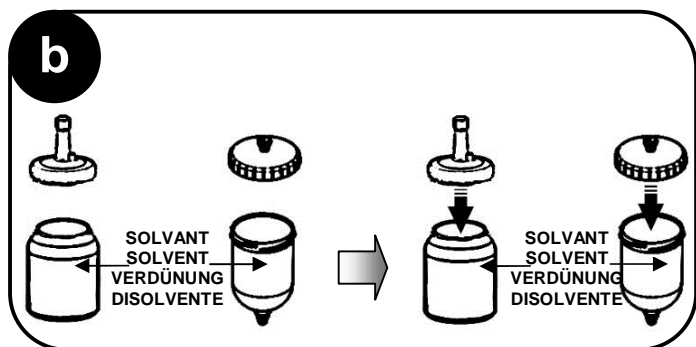
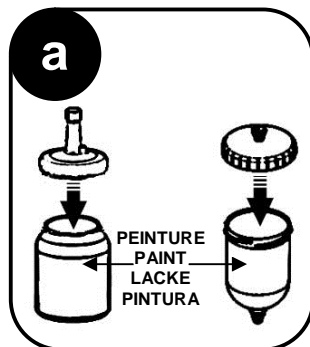
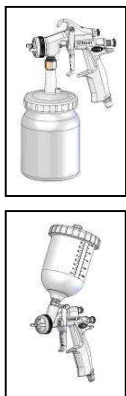
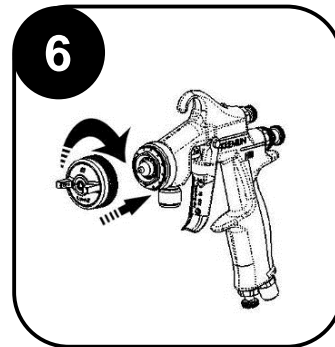
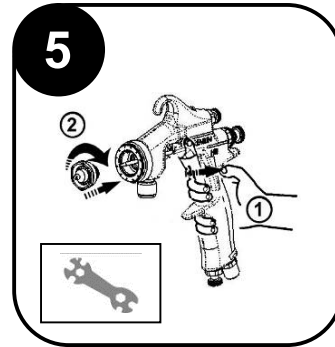
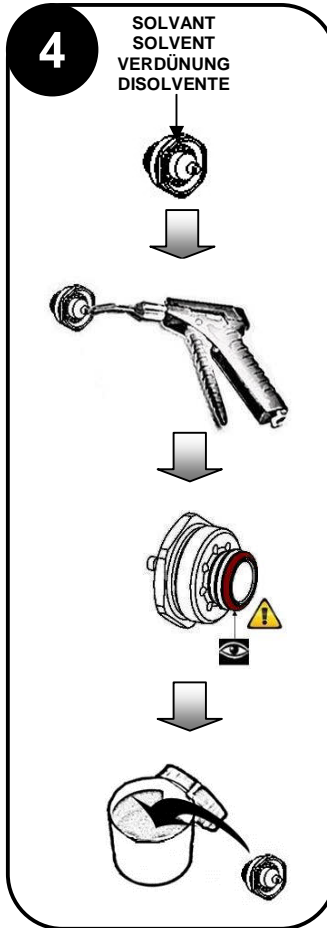
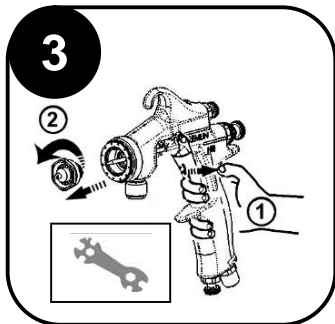
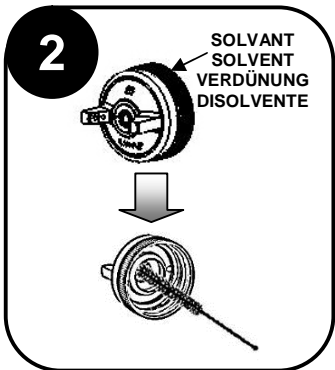
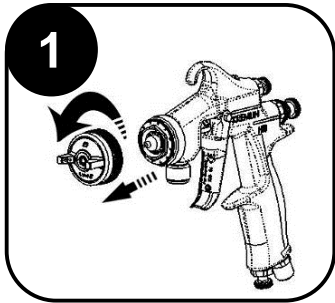

TOUS LES MOIS / MONTHLY TASKS/ WÖCHENTLICH / SEMANAL

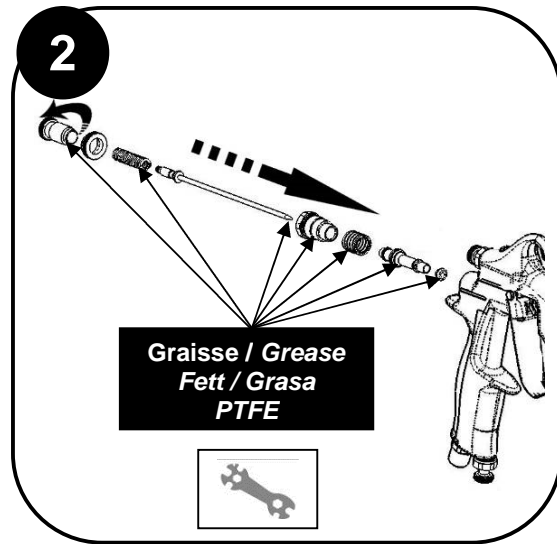
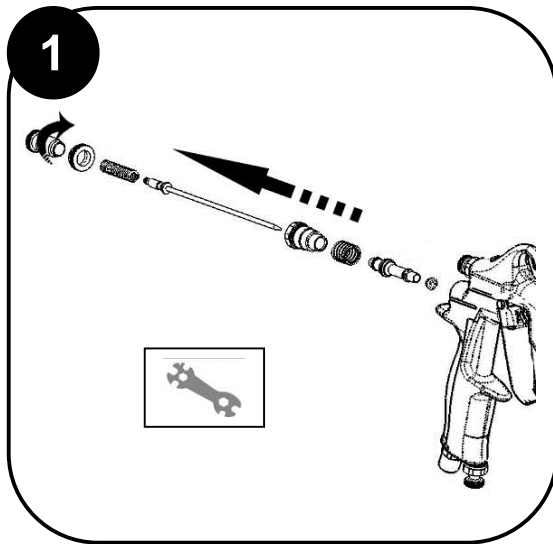
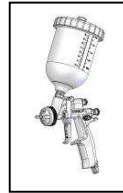

DEMONTAGE / REMONTAGE  
DISASSEMBLY / REASSEMBLY  
DEMONTAGE / MONTAGE  
DESMONTAJE / MONTAJE

TOUS LES ANS / YEARLY SERVICE / JÄHRLICH / ANUAL

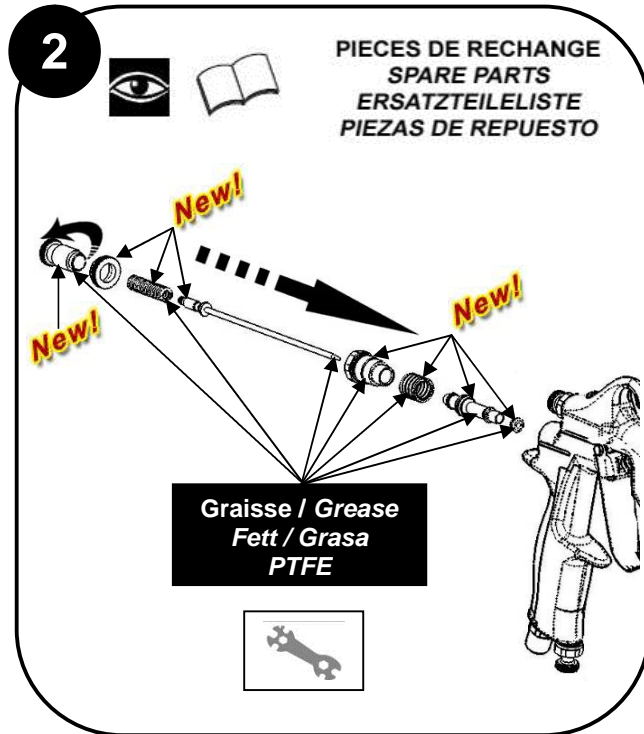
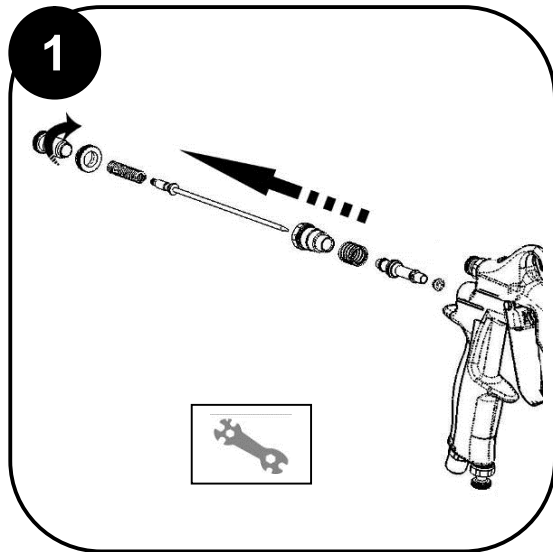
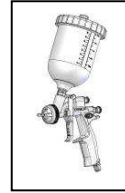

# GUIDE DE DEPANNAGE TROUBLESHOOTING GUIDE FEHLERSUCHE INCIDENCIAS DE FUNCIONAMIENTO

## PISTOLET PNEUMATIQUE MANUEL / MANUAL AIRSPRAY GUN / HAND LUFTSPRITZPISTOLE / PISTOLA NEUMÁTICA MANUAL

AVANT CHAQUE OPERATION DE MAINTENANCE / DO THIS BEFORE ANY MAINTENANCE ACTION  
VOR JEDER WARTUNGSARBEIT IST FOLGENDES ZU TUN / ANTES DE CADA OPERACIÓN DE MANTENIMIENTO



0 bar / psi

**AIR PROPRE  
CLEAN AIR  
TROCKENER  
DRUCKLUFT  
AIRE LIMPIO**



**PRESSION D'AIR  
AIR PRESSURE  
LUFTDRUCK  
PRESIÓN DE AIRE**



1 bar / 14.5 psi

**AIR PROPRE  
CLEAN AIR  
TROCKENER  
DRUCKLUFT  
AIRE LIMPIO**



**PRESSION D'AIR  
AIR PRESSURE  
LUFTDRUCK  
PRESIÓN DE AIRE**



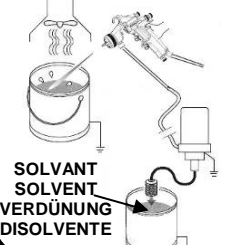

**SOLVANT  
SOLVENT  
VERDÜNUNG  
DISOLVENTE**

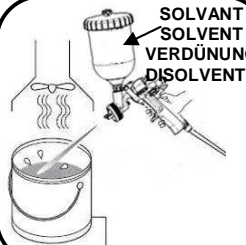

**SOLVANT  
SOLVENT  
VERDÜNUNG  
DISOLVENTE**

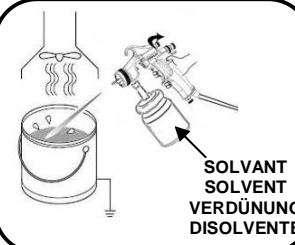

**SOLVANT  
SOLVENT  
VERDÜNUNG  
DISOLVENTE**

0 bar / Psi



**DECOMPRIMER LE CIRCUIT DE PEINTURE  
DEPRESSURIZE THE SPRAY PAINT CIRCUIT  
DAS MATERIALEITUNGEN DRUCKENLASTEN  
DESCOMPRESION EL CIRCUITO DE PINTURA**

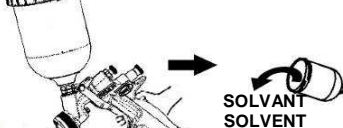

**SOLVANT  
SOLVENT  
VERDÜNUNG  
DISOLVENTE**

**CIRCUIT DE PEINTURE  
SPRAY PAINT CIRCUIT  
MATERIALEITUNGEN  
CIRCUITO DE PINTURA**

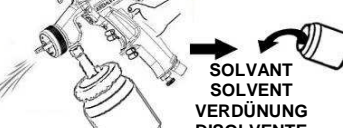

**SOLVANT  
SOLVENT  
VERDÜNUNG  
DISOLVENTE**

**CIRCUIT DE PEINTURE  
SPRAY PAINT CIRCUIT  
MATERIALEITUNGEN  
CIRCUITO DE PINTURA**



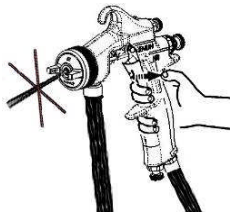

PAS DE DÉBIT / NO FLOW  
KEIN FARBAUSTRITT  
AUS DER PISTOLE  
LA PINTURA NO SALE  
POR LA PISTOLA

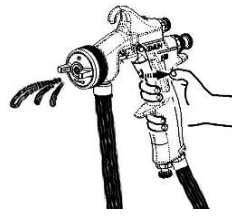

DÉBIT FAIBLE  
LOW FLOW RATE  
ZU WENIG  
MATERIALAUSBRINGENGE  
CAUDAL BAJO

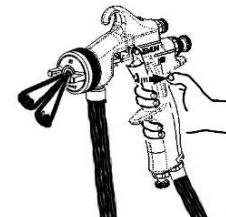

JET DÉFORMÉ  
SPRAY FAN NOT UNIFORM  
SPRITZBILD UNGLEICHMÄßIG  
CHORRO DEFORMADO

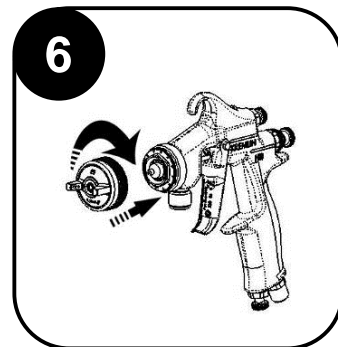
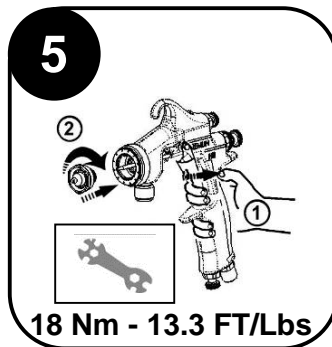
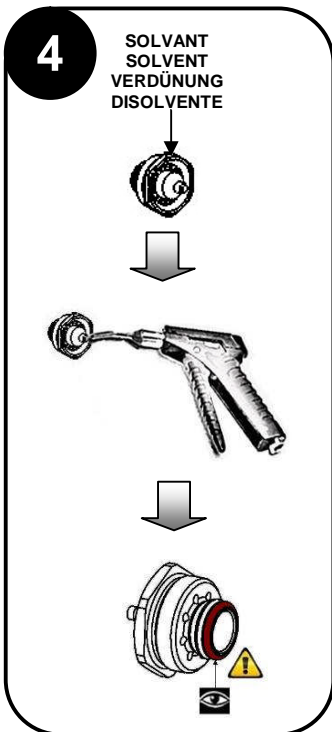
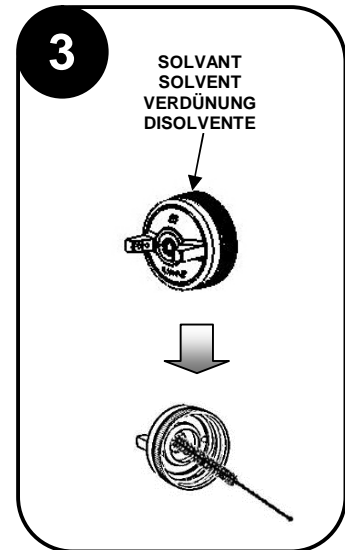
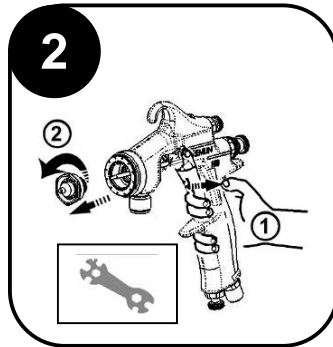
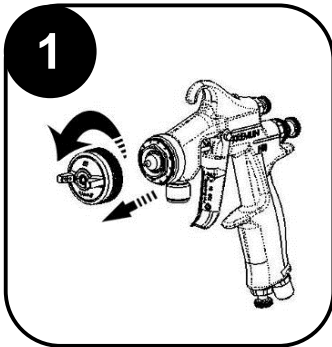



JET EN FORME DE HARICOT / DISTORTED SPRAY FAN  
DER SPRITZSTRAHL IST BONGENFÖRMIG / ABANICO EN FORMA DE ARCO



1/2 TOUR  
1/2 ROTATION  
1/2 DREHUNG  
1/2 VUELTA

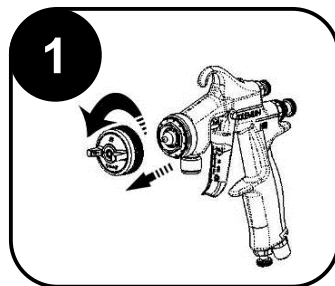

1

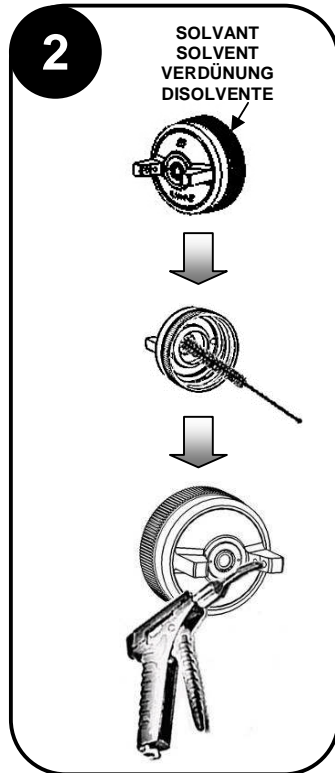

2

SOLVANT  
SOLVENT  
VERDÜNNUNG  
DISOLVENTE

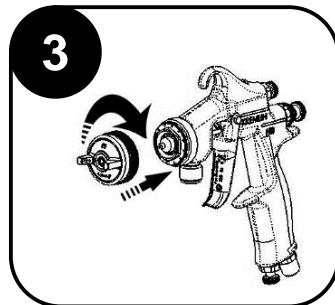

3



DEMONTAGE / REMONTAGE  
DISASSEMBLY / REASSEMBLY  
DEMONTAGE / MONTAGE  
DESMONTAJE / MONTAJE

PIECES DE RECHANGE  
SPARE PARTS  
ERSATZTEILELISTE  
PIEZAS DE REPUESTO

New!





**JET DÉPORTÉ / DISPLACED SPRAY FAN**  
**UNGLEICHMÄßIGER SPRITZSTRAHL / ABANICO DEFORMADO**

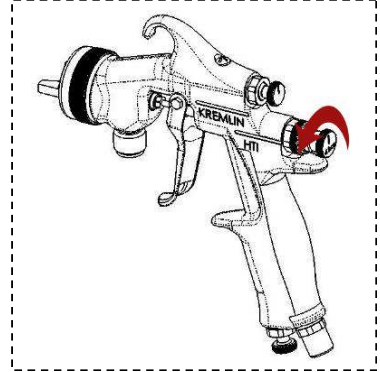
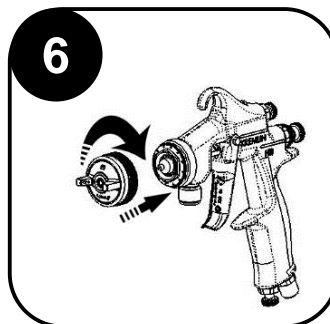
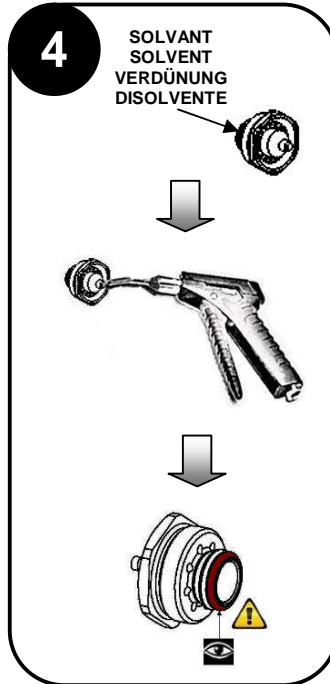
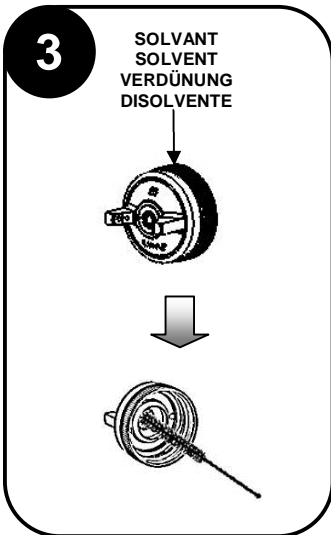
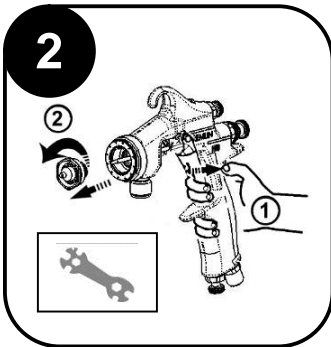
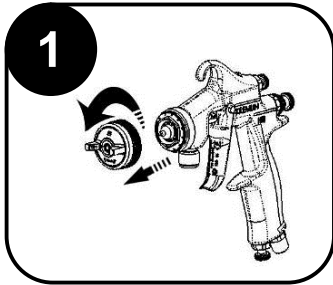





JET COUPÉ / FRAGMENTED SPRAY FAN  
 STRAHL IST IN DER MITTE DÜNNER / ABANICO CORTADO

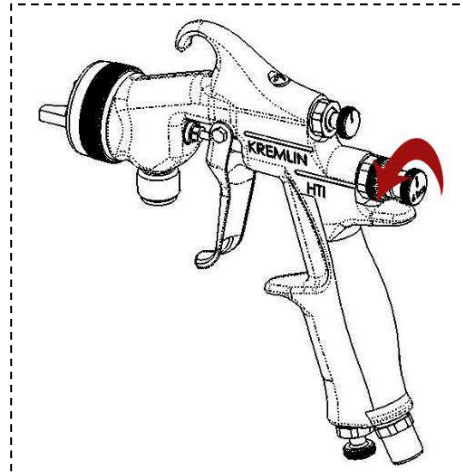
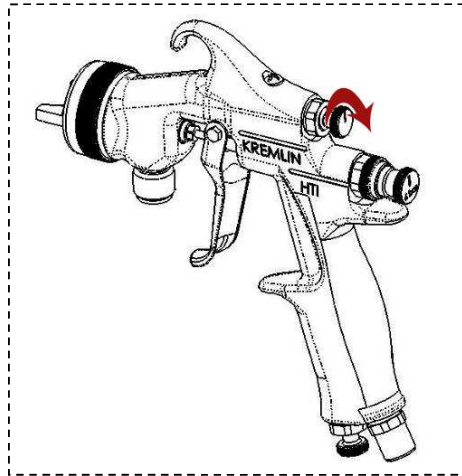

JET CHARGÉ AU CENTRE / SPRAY FAN TOO LARGE IN THE CENTER  
 STRAHL IST IN DER MITTE BREITER / ABANICO CARGADO EN EL CENTRO

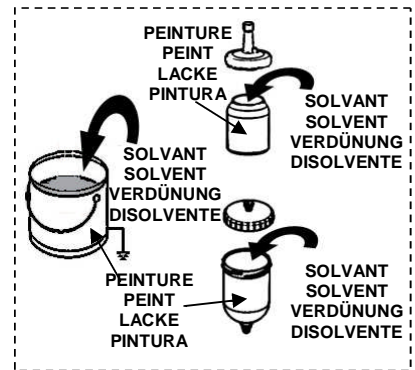
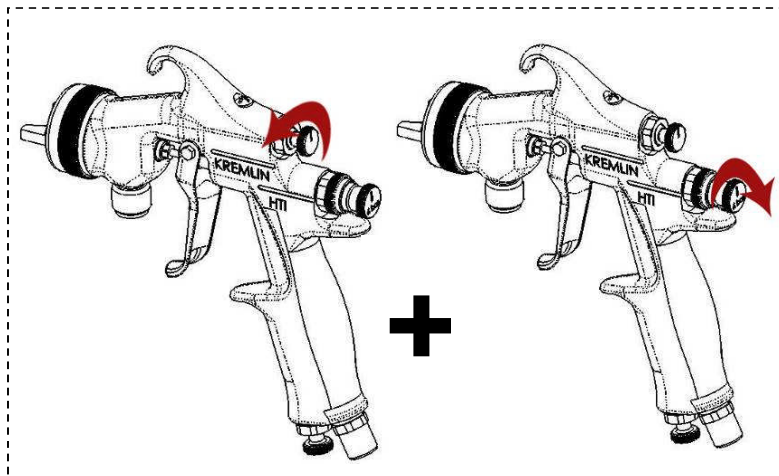

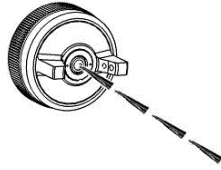

**JET DE PEINTURE SACCADE / INTERMITTANT SPRAY FAN  
 SPRITZSTRAHL FLATTERT / ABANICO ENTRE CORTADO**

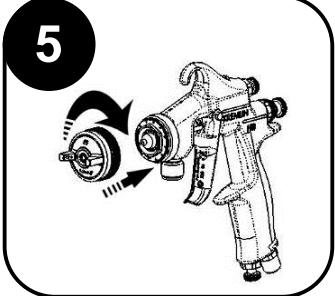
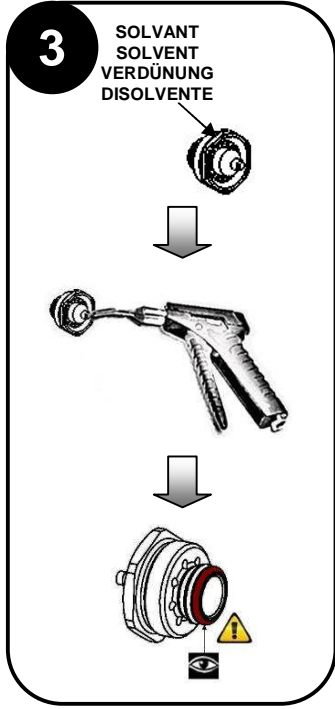
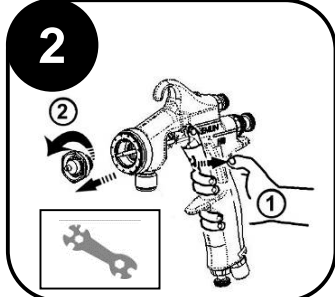
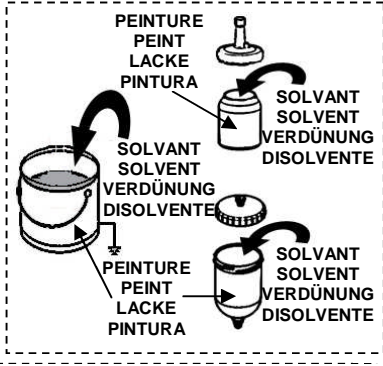
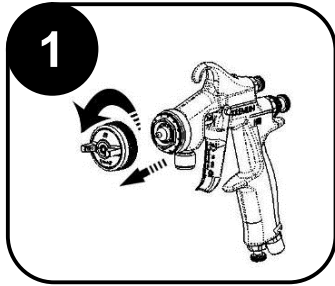
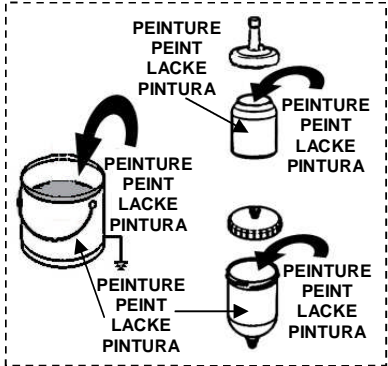

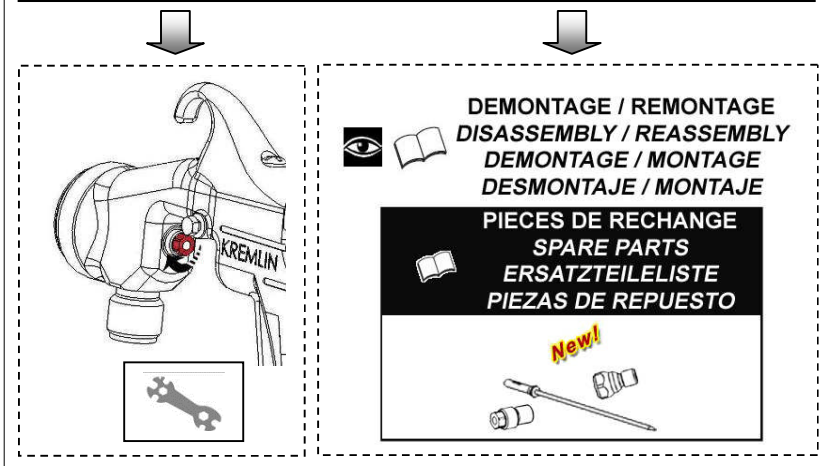
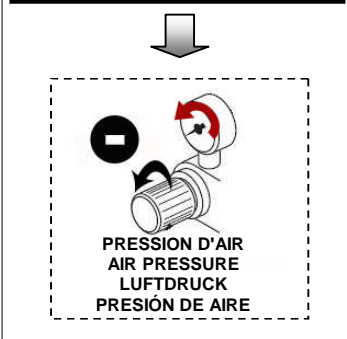
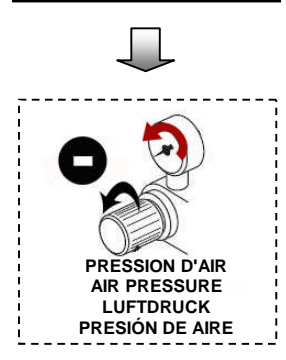
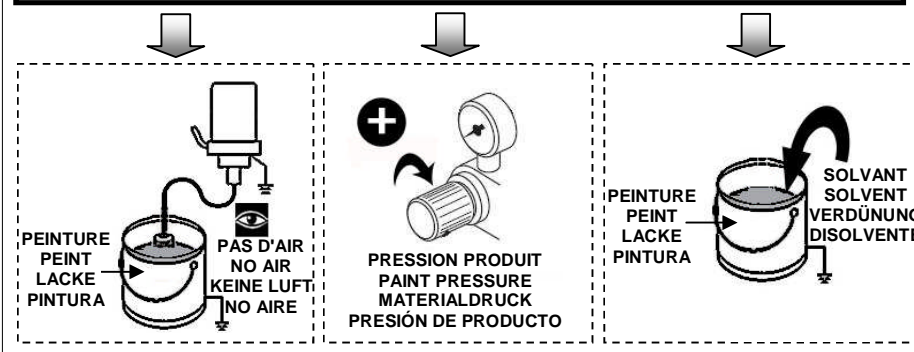
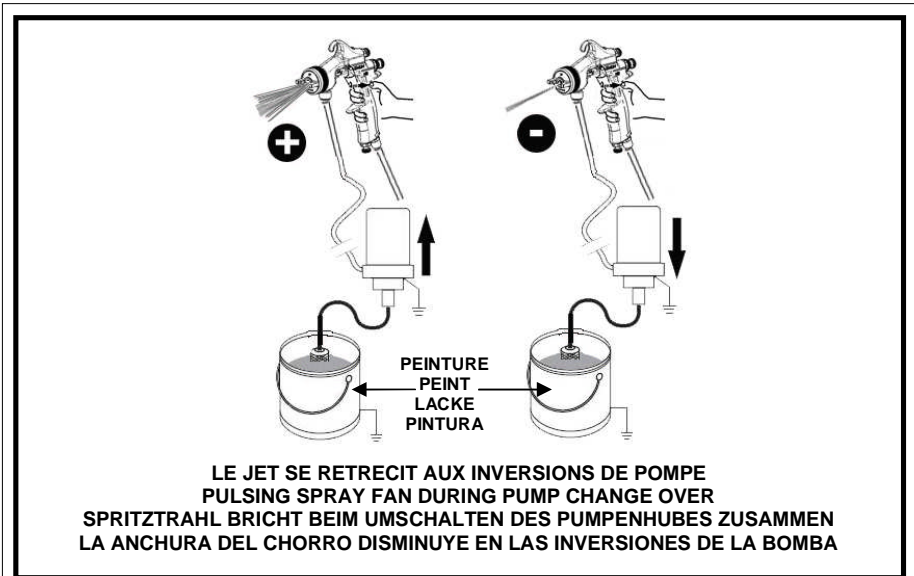



PEINTURE / PAINT  
/ LACKE / PINTURA

FUITE DE PEINTURE PAR LES TROUS D'AIR DE LA TETE DU PISTOLET  
PAINT LEAKING FROM AIR HOLES OF THE CAP  
MATERIAL KOMMT AUS LUFTBOHRUNG DES DÜSENKOPFES  
PINTURA SALE POR LOS AGUJEROS DE AIRE DEL CABEZAL

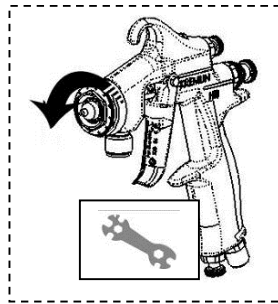
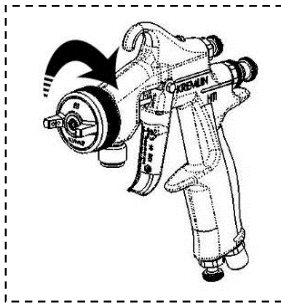

DEMONTAGE / REMONTAGE  
DISASSEMBLY / REASSEMBLY  
DEMONTAGE / MONTAGE  
DESMONTAJE / MONTAJE

PIECES DE RECHANGE  
SPARE PARTS  
ERSATZTEILELISTE  
PIEZAS DE REPUESTO

**New!**

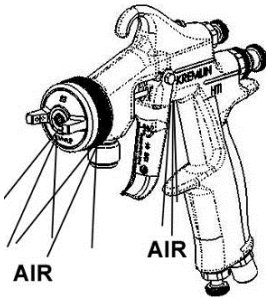

FUITE D'AIR A L'AVANT DU PISTOLET  
AIR LEAKING FROM AIR CAP  
BESTÄNDIGER LUFTAUSSTRITT AM DÜSENKOPF  
FUGA DE AIRE POR LA PARTE DELANTERA  
DE LA PISTOLA



DEMONTAGE / REMONTAGE  
DISASSEMBLY / REASSEMBLY  
DEMONTAGE / MONTAGE  
DESMONTAJE / MONTAJE

PIECES DE RECHANGE  
SPARE PARTS  
ERSATZTEILELISTE  
PIEZAS DE REPUESTO

**New!**



# **PNEUMATIC MANUAL SPRAY GUN**

## ***START-UP, ADJUSTMENT AND HANDLING***

### **TRANSLATION FROM THE ORIGINAL MANUAL**

***IMPORTANT : Before assembly and start-up, please read and clearly understand all the documents relating to the equipment (professional use only).***

THE PICTURES AND DRAWINGS ARE NOT CONTRACTUAL. WE RESERVE THE RIGHT TO MAKE CHANGES WITHOUT PRIOR NOTICE.

#### **KREMLIN - REXSON**

150, avenue de Stalingrad

93 245 - STAINS CEDEX – France

**☎** : 33 (0)1 49 40 25 25      **Fax** : 33 (0)1 48 26 07 16

**[www.kremlin-rexson.com](http://www.kremlin-rexson.com)**

## 1. START-UP



### Safety instructions :

- Never try to stop the spray fan with any part of the body (hands, fingers...) or with rags. Never point the spray gun at anyone or at any part of the body.
- The operator will need medical attention if the high pressure material spray is in contact with the the body (eyes, fingers...).
- **Always depressurize air and hoses** before carrying out any servicing on the gun.



In order to protect the operator, protective clothing (gloves, respirator mask, glasses, hearing protective earplug, clothes...) are required.

Use the equipment in a properly ventilated area.

- 1- Unscrew the needle adjustment knob at the back of the gun.
  - 2- Unscrew the air adjuster (s).
  - 3- Select the desired projector (aircap + nozzle + needle) best suited for the job at hand.
  - 4- Screw on the nozzle, then the aircap to the gun.
- ➡ We advice you to put the gun in the "OPEN" position to prevent any damage to the needle while fitting the nozzle
- 5 -Before tightening up firmly the aircap ring, position the aircap for the best spray. The fan is vertical when the 2 "ears" of the aircap are horizontal.
  - 6 - Trigger the gun.

## 2. ADJUSTMENT

This professional spray gun features 3 controls :

### ▪ SPRAYING FINENESS

It is realized by the central air. The air is adjusted by means of the air regulator mounted upstream of the gun on the network and more finely by means of the knob at the bottom of the gun handle of some manual guns.

### ▪ FAN WIDTH

Can be adjusted by using the knurled knob. It controls the air going to the horns on the aircap. In this way, the air is controlled through the fanned air outlets and allows the fan to change from flat (wide open) to round (closed).

### ▪ FLUID OUTPUT

Having selected the proper fluid nozzle / needle assembly and the fluid pressure, it is possible to further control the output by changing the travel of the needle (needle stop knob).

Optimal set-up is usually obtained when the product needle is completely open. When this needle is nearly closed, a regular flow of product can not be guaranteed

### 3. GUN HANDLING

When mounting the aircap on the gun, hold it vertically in order to correctly adjust the aircap before screwing the aircap ring.

Keep the gun perpendicular to the surface to be painted. Avoid working with the wrist.

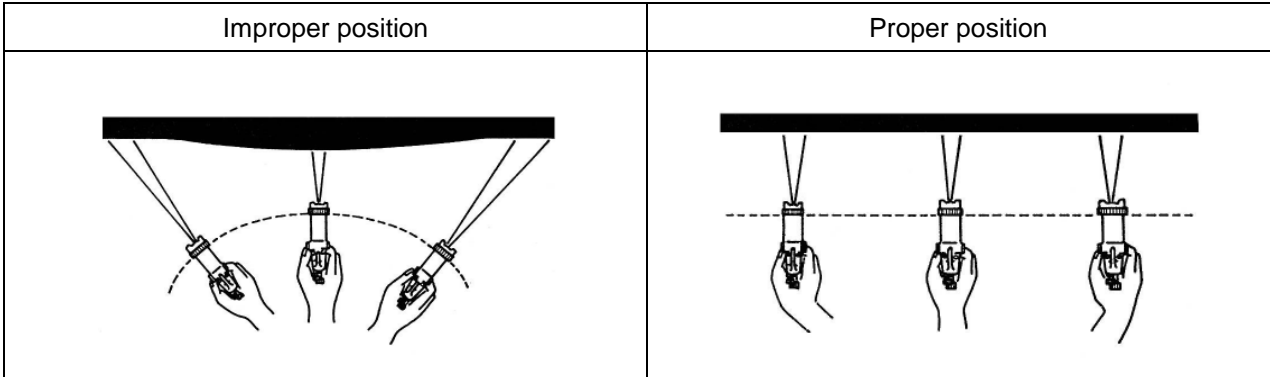

Do not forget that crossed sweeps cannot correct irregularities.

Spraying from a stationary gun will not give you even coverage. Start the pass and trigger just before the leading edge. Release the trigger before the pass ends, just after the trailing edge of the object.

Make sure that overlapping from the passes is even.

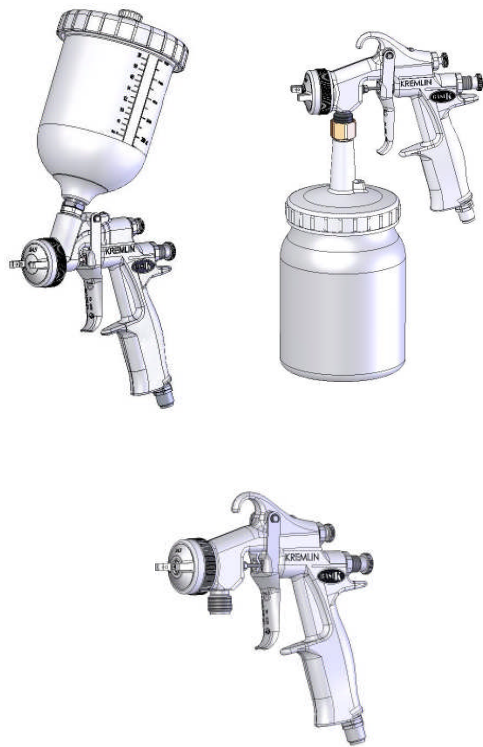

## AIRSPRAY GUN

**M 22**

**TECHNICAL FEATURES**

### TRANSLATION FROM THE ORIGINAL MANUAL

***IMPORTANT : Before assembly and start-up, please read and clearly understand all the documents relating to the equipment (professional use only).***

THE PICTURES AND DRAWINGS ARE NOT CONTRACTUAL. WE RESERVE THE RIGHT TO MAKE CHANGES WITHOUT PRIOR NOTICE.

#### **KREMLIN - REXSON**

150, avenue de Stalingrad  
93 245 - STAINS CEDEX - France

**☎** : 33 (0)1 49 40 25 25      **Fax** : 33 (0)1 48 26 07 16

**[www.kremlin-rexson.com](http://www.kremlin-rexson.com)**



# 1. M 22 BASIK

## 1.1. Description

Robust, multi-purpose gun for intensive works.

There are 3 versions of the M22 BasiK gun : gravity, suction and pressure.

## 1.2. Technical features

FEATURES	M 22 G BasiK (BA 5 aircap)	M 22 A BasiK (BA 2 aircap)	M 22 P BasiK (BA 3 aircap)
Version	HPA gravity gun	HPA suction gun	HPA pressure gun
Air supply maximum pressure (network)	6 bar / 87 psi		
Air pressure at the gun handle	From 2 to 4 bar / from 29 to 58 psi		
Air flow rate (m <sup>3</sup> /h) (at 3 bar)	28 m <sup>3</sup> /h / 16.5 c.f.m	24 m <sup>3</sup> /h / 14.1 c.f.m	30 m <sup>3</sup> /h – 17.7 c.f.m
Fluid supply maximum pressure	Gravity cup (0.6 l)	SM 6 suction cup (1 l)	Maximum 6 bar / 87 psi
Weight	690 g / 1.5 lb	1000 g / 2.2 lb	530 g / 1.1 lb
Transfer rate (EN 13966-1 Standard) (α)	65 % ± 2	62 % ± 2	63 % ± 2
Wetted parts	Stainless steel	Stainless steel	Stainless steel
Nozzle / Needle	Stainless steel / Treated stainless steel		
Cup	Poyacetale	aluminium	-
Fluid maximum temperature	50°C / 122° F		

(α) : Paint viscosity : 20 s CA n° 4 - 20°C / Gun aircap distance - surface to be painted : 20 cm / 8"

### ▪ AIR AND FLUID CONNECTIONS

Gun	Fluid	Air
<b>M 22 G BasiK</b>	Poyacetale gravity cup (0.6 liter / 0.16 US gal) (white colour) for water based or solvanted paints	Gun fitting : M 1/4 NPS (+ fitting, model double male 1/4 BSP not mounted)  ⇒ Air hose (non static quality) <b>minimum 7 mm / 1/4" ID</b> (for a 7.5 m / 25 ft length)
<b>M 22 A BasiK</b>	Gun fitting : M 3/8 NPS + SM6 suction cup (1 liter, aluminium)	
<b>M 22 P BasiK</b>	Gun fitting : M 3/8 NPS ⇒ Fluid hose : minimum 7 mm / 1/4" ID (for a 7.5 m / 25 ft length)	

▪ **PRESSURE AND AIR CONSUMPTION OF THE GUNS**

Adjustment of the air pressure with or without gauge at the gun handle

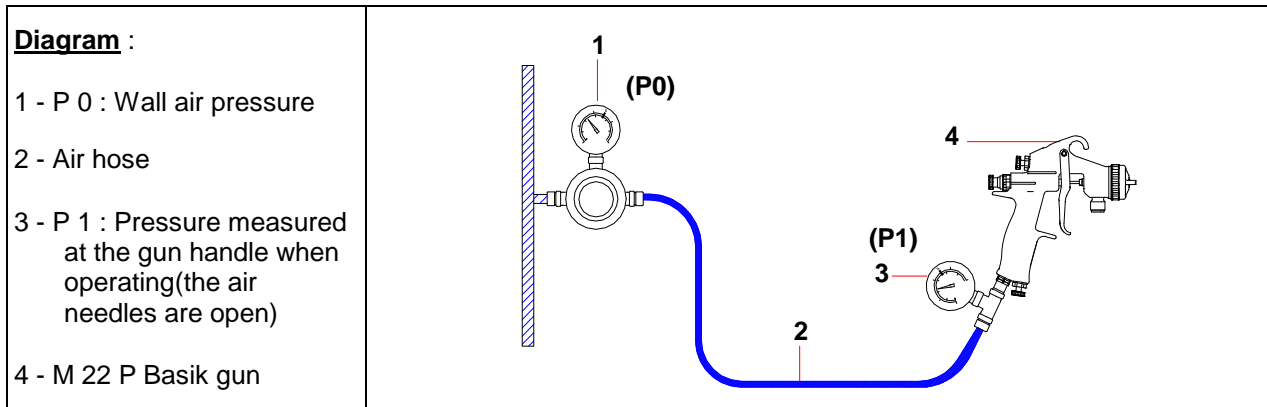

M 22 G BasiK gun + BA 5 aircap + hose, model 7 mm / 1/4" ID, 7.5 m / 25 ft length				M 22 P BasiK gun + BA 3 aircap + hose, model 7 mm / 1/4" ID, 7.5 m / 25 ft length			
P 0 wall pressure		P 1 handle pressure		P 0 wall pressure		P 1 handle pressure	
(bar)	(psi)	(bar)	(psi)	(bar)	(psi)	(bar)	(psi)
3,2	46	2	29	3,2	46	2	29
3,8	55	2,5	36	4	58	2,5	36
4,5	65	3	43,5	4,5	65	3	43,5
5	72	3,5	50	5	73	3,5	50
5,5	79.8	4	58	5,5	79.8	4	58

**Gravity gun : M 22 G BasiK with 18 BA 5 projector**

Air pressure (P1)		Air flow rate		Paint flow rate (2)		Fan width (3)	
bar	PSI	m3/h	CFM	g/mn	oz/mn	cm	"
3	43.5	28	16.5	280	9.9	31	12.2

**Suction gun : M 22 A BasiK with 15 BA 2 projector**

Air pressure (P1)		Air flow rate		Paint flow rate (2)		Fan width (3)	
bar	PSI	m3/h	CFM	g/mn	oz/mn	cm	"
3	43.5	24	14.1	220	7.8	24,5	9.6

**Pressure gun : M 22 P BasiK with 9 BA 3 projector**

Air pressure (P1)		Air flow rate		Paint flow rate (2)		Fan width (3)	
bar	PSI	m3/h	CFM	g/mn	oz/mn	cm	"
3	43.5	30	16.7	250	8.8	31	12.2

(2)	Paint viscosity : 20 s CA n° 4 ( = 40 centipoises)
(3)	Gun aircap distance - surface to be painted : 20 cm / 8"

## 2. M 22 HTi - HPA (A & P)

### 2.1. Description

Guns recommended to spray varnishes, lacquers, shades, polyurethanes, two components...

The HTi guns are pneumatic guns with a high transfer efficiency. Two projectors, models EP 3 and E 3 KHVLP can be fitted on the same gun. For higher rates, we recommend the use of projectors, models ER1, ER2, ER3, ER4, ER9 and ES9.

The guns, model HPA, with high spraying quality, enable to spray any kind of materials (low or high viscosity). Two projectors, models EN 2 (for M 22, suction version) and EN 3 (for M 22, pressure version) can be fitted on the same on the gun.

### 2.2. Technical features

FEATURES	HTi		HPA	
	+ E 3 KHVLP aircap	+ EP 3 aircap	+ EN 3 aircap	+ EN 2 aircap
Version	pressure	pressure	pressure	suction
Maximum air supply pressure (network)	6 bar / 87 psi			
Air pressure at the gun handle	From 1,5 to 2,5 bar / from 22 to 36 psi	From 1,5 to 2,5 bar / from 22 to 36 psi	From 2,5 to 3,5 bar / from 36 to 50.7 psi	From 2,5 to 3,5 bar / from 36 to 50.7 psi
Air flow (m3/h)	From 23 to 33	From 20,2 to 29	From 28 to 36,1	From 23 to 29,7
Fluid supply maximum pressure	6 bar / 87 psi	6 bar / 87 psi	6 bar / 87 psi	SM 6 cup (1 liter)
Weight	530 g / 1.17 lb			
Shades and hydro or solvent based varnishes				
- low viscosity	***	**	**	**
- middle viscosity	***	***	***	***
- high viscosity	**	**	***	***
Transfer rate (EN 13966-1 standard)	74 % ± 2 %	72 % ± 2 %	63 % ± 2 %	
Maximum fluid temperature	50°C / 120° F			
Nozzle, needle, fluid passage	Stainless steel			
Needle	Treated stainless steel			

(1) : Paint viscosity : 20 s CA n° 4 - 20°C - 68°F / Gun aircap distance - surface to be painted : 20 cm / 8"

**Nota : For HTi gun fitted with a E 3 aircap, the maximum inlet air pressure at the gun handle must not exceed 2 bar (29 psi) to maintain 0.7 bar (10.1 psi) or less at the air cap.**

#### ■ AIR AND FLUID SUPPLY

M 22 gun, model HTi & HPA	Fittings mounted on the gun	Air and fluid supply
Air	Male 1/4 NPS	Air hose (non-static hose) <b>HTi : minimum 8 mm ID</b> (for a 7.5 m / 24.6 ft length) <b>HPA : minimum 7 mm ID</b> (for a 7.5 m / 24.6 ft length)
Fluid	Male 3/8 NPS	For pressure gun (HTi & HPA) : Fluid hose : minimum 7 mm ID (for a 7.5 m / 24.6 ft length) For HPA suction gun : SM 6 cup (1 liter)

▪ **PRESSURE AND AIR CONSUMPTION OF THE GUNS**

**Air pressure adjustment with or without gauge at the gun handle**

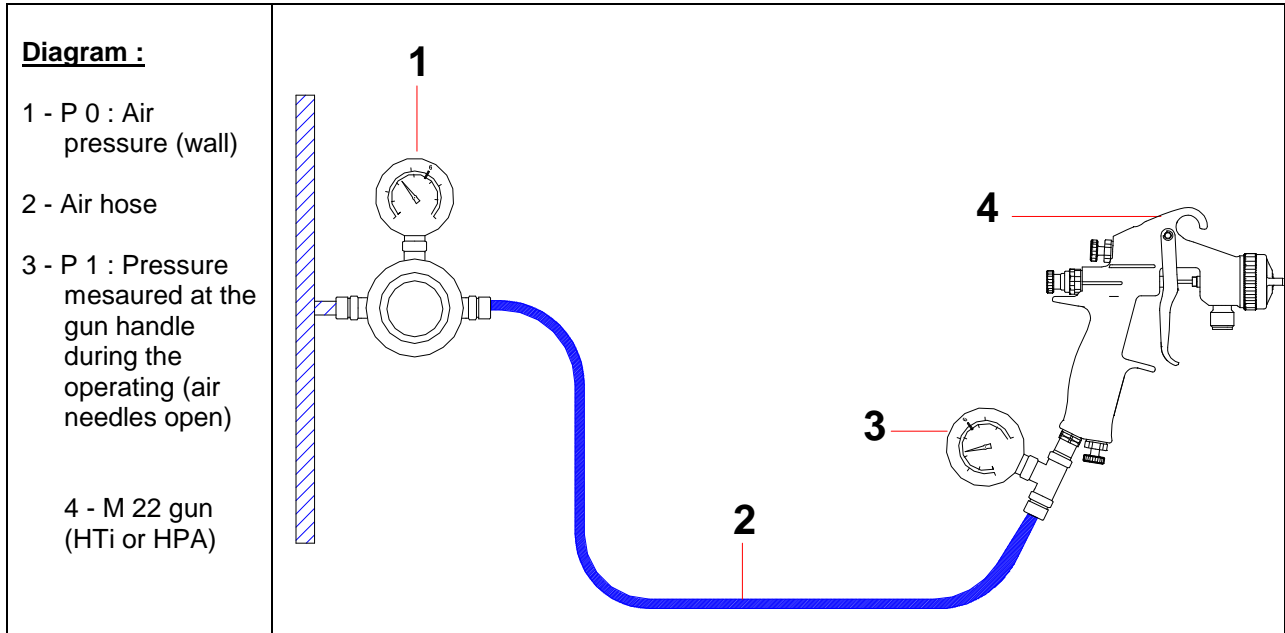

<b>HTi gun + E 3 K HVLP aircap + hose Ø 8 mm (7.5 m / 24.6 ft length)</b>	<b>HPA gun + EN 3 aircap + hose Ø 7 mm (7.5 m / 24.6 ft length)</b>
-------------------------------------------------------------------------------	-------------------------------------------------------------------------

P 0		P 1		P 0		P 1	
(bar)	(psi)	(bar)	(psi)	(bar)	(psi)	(bar)	(psi)
2,2	32	1,5	22	2,6	38	1,5	22
3	44	2	29	3,2	46	2	29
3,5	51	2,5	36	4	58	2,5	36
4,1	60	3	44	4,5	65	3	44
4,7	68	3,5	51	5	73	3,5	51

**HTi with projector, model 9 E 3 KHVLP**

Air pressure (P 1)		Air flow rate	
bar	PSI	m3/h	CFM
1,5	21.75	23	13.5
2	29	28	16.5
2,5	36	33	19.4
3	43.5	38	22.4
3,5	50	42,6	25

Fluid flow (2)		Fan width (3)	
g/mn	oz/mn	cm	"
250	8.8	33	13
250	8.8	34	13.4
250	8.8	35	13.8

**HTi with projector, model 9 EP 3**

Air pressure (P 1)		Air flow rate	
bar	PSI	m3/h	CFM
1,5	21.75	20,2	11.9
<b>2</b>	<b>29</b>	<b>24,5</b>	<b>14.4</b>
2,5	36	29	17
3	43.5	33,2	19.5
3,5	50	37,3	22

Fluid flow (2)		Fan width (3)	
g/mn	oz/mn	cm	"
250	8.8	31	12.2
<b>250</b>	<b>8.8</b>	<b>30,5</b>	<b>12</b>
250	8.8	30,5	12
300	10.6	32	12.6
300	10.6	32	12.6

**HPA pressure version with projector, model 9 EN 3**

Air pressure (P 1)		Air flow rate	
bar	PSI	m3/h	CFM
2	29	23,8	14
2,5	36	28	16.5
<b>3</b>	<b>43.5</b>	<b>32,2</b>	<b>18.9</b>
3,5	50	36,1	21.2

Fluid flow (2)		Fan width (3)	
g/mn	oz/mn	cm	"
300	10.6	29,5	11.6
<b>300</b>	<b>10.6</b>	<b>29,5</b>	<b>11.6</b>
300	10.6	27,5	10.8

**HPA suction version with projector, model 15 EN 2**

Air pressure (P 1)		Air flow rate		Fluid flow (2)		Fan width (3)	
bar	PSI	m3/h	CFM	g/mn	oz/mn	cm	"
1,5	21.75	16	9.4	107	3.8	19,5	7.7
2	29	19,5	11.5	188	6.6	23	9
2,5	36	23	13.5	198	7	24,5	9.6
<b>3</b>	<b>43.5</b>	<b>26,4</b>	<b>15.5</b>	<b>218</b>	<b>7.7</b>	<b>27,5</b>	<b>10.8</b>
3,5	50	29,7	17.5	207	7.3	28,5	11.2

(2)	Fluid viscosity : 20 s CA n° 4 ( = 40 centipoises)
(3)	Distance gun aircap - surface to be painted : 20 cm
	Optimum fan adjustment

### 3. M 22 HTI - HPA (G)

#### 3.1. Description

Guns recommended to spray varnishes, lacquers, shades, polyurethanes, two components...

The HTI guns are pneumatic guns with a high transfer efficiency. Two projectors, models EP 5 and E 5 K HVLP can be fitted on the same gun.

The guns, model HPA, with high spraying quality, enable to spray any kind of materials (low or high viscosity).

#### 3.2. Technical features

FEATURES	HTi (E 5 K HVLP aircap)	HTi (EP 5 aircap)	HPA (EN 5 aircap)
Maximum air supply pressure (network)	6 bar / 87 psi		
Air pressure at the gun handle	From 1,5 to 2,5 bar / from 22 to 36 psi	From 2 to 3 bar / from 29 to 44 psi	From 2 to 4 bar / from 29 to 58 psi
Air flow	27,2 m3/h to 2 bar / 16 CFM to 29 psi	20,2 m3/h to 2,5 bar / 11.9 CFM to 36 psi	26,5 m3/h to 2,5 bar / 15.6 CFM to 36 psi
Fluid supply	Gravity cup (0,6 liter)		
Weight (gun without cup)	530 g / 1.17 lb		
Weight (gun with cup)	690 g / 1.52 lb		
Shades and hydro or solvent based varnishes			
- low viscosity	* * * *	* * *	* * *
- middle viscosity	* * * *	* * * *	* * * *
- high viscosity	* *	* * *	* * * *
Minimum transfer rate (1) (EN 13966-1 standard)	76 % ± 2 %	74 % ± 2 %	-
Maximum fluid temperature	50° C / 120° F		
Nozzle, needle, fluid passage	Stainless steel / anodized aluminium		
White cup (acetale resin)	For hydro and solvent based paints		
Grey cup (PEHD)	For PU and pre catalysed materials		

(1) : Paint viscosity : 20 s CA n° 4 - 20°C - 68°F / Gun aircap distance - surface to be painted : 20 cm / 8"

**Nota : For HTi gun fitted with a E 5 aircap, the maximum inlet air pressure at the gun handle must not exceed 2 bar (29 psi) to maintain 0.7 bar (10.1 psi) or less at the air cap.**

#### ▪ AIR AND FLUID SUPPLY

M 22 guns, model HTi & HPA	Elements mounted on the spray gun (depending on model)	Air and fluid supply
<b>Air</b>	Fitting : M 1/4 NPS (+ MM 1/4 BSP not mounted)	Air hose (non-static hose) HTi : minimum 8 mm int. ID (for a 7.5 m / 24.6 ft length) HPA : minimum 7 mm ID (for a 7.5 m / 24.6 ft length)
<b>Fluid</b>	White or grey gravity cup (0,6 liter)	Option : white cup (0,25 liter) grey cup (0,25 liter)

▪ **PRESSURE AND AIR CONSUMPTION OF THE GUNS**

Air pressure adjustment with or without gauge at the gun handle.

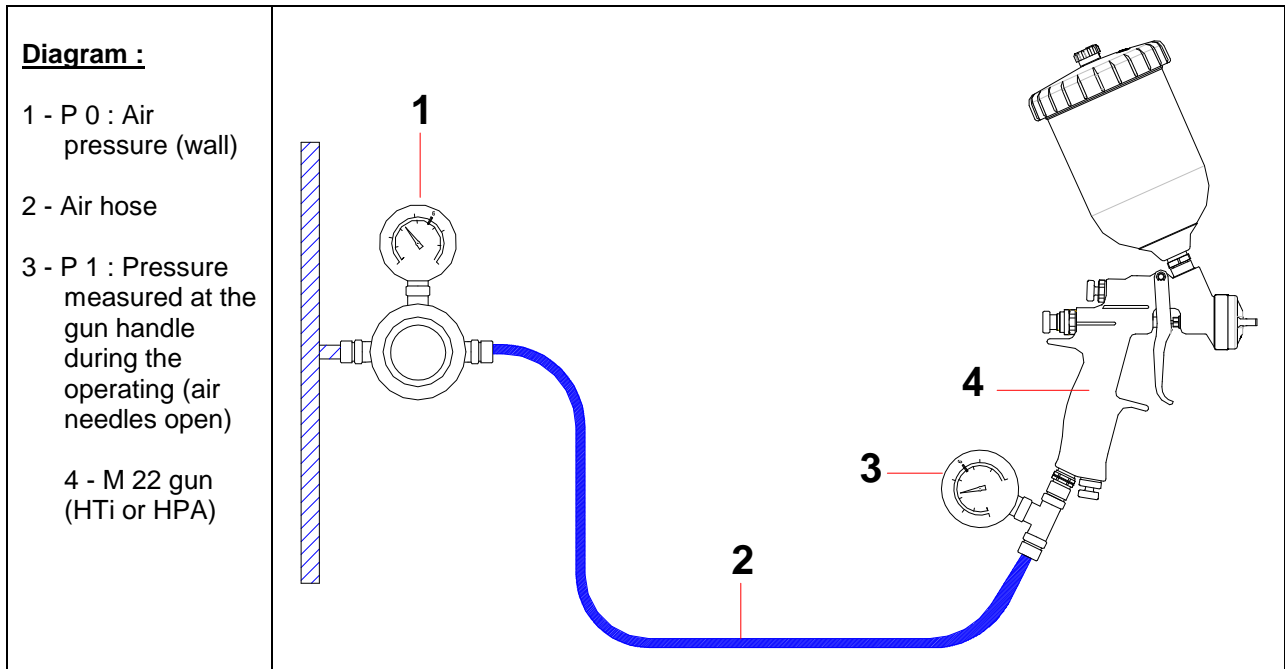

<b>HTi gun + E5 K HVLP aircap + hose Ø 8 mm (7.5 m / 24.6 ft length)</b>	<b>HPA gun + EN 5 aircap + hose Ø 7 mm (7.5 m / 24.6 ft length)</b>
------------------------------------------------------------------------------	-------------------------------------------------------------------------

P 0		P 1		P 0		P 1	
(bar)	(psi)	(bar)	(psi)	(bar)	(psi)	(bar)	(psi)
2,25	33	1,5	22	2,5	36	1,5	22
3	44	2	29	3,2	46	2	29
3,5	51	2,5	36	3,8	55	2,5	36
4,2	61	3	44	4,5	65	3	44
4,75	69	3,5	51	5	72	3,5	51

Air pressure (P 1)	HTi + E 5 (K HVLP) aircap		HTi + EP 5 aircap		HPA + EN 5 aircap	
	(m3/h)	(CFM)	(m3/h)	(CFM)	(m3/h)	(CFM)
1,5 bar / 21.75 psi	21,5	12.7	14	8.2	-	-
2 bar / 29 psi	27,2	16	17	10	22,8	13.4
2,5 bar / 36 psi	32,9	19.4	20,2	11.9	26,5	15.6
3 bar / 43.5 psi			23	13.6	30,2	17.8
3,5 bar / 50.8 psi			26	15.3	36,9	21.7
4 bar / 58 psi					40,6	23.9

Nozzle	Fluid flow (2)					
	(cm <sup>3</sup> /mn)	(oz/mn)	(cm <sup>3</sup> /mn)	(oz/mn)	(cm <sup>3</sup> /mn)	(oz/mn)
13	170	6	173	6.1	210	7.4
14	200	7	214	7.6	238	8.4
15	245	8.6	229	8.1	256	9
18	260	9.2	275	9.7	282	10
22	284	10	342	12.1	345	12.2

Distance gun aircap - surface to be painted	Fan width with nozzle 14 (3)					
	(cm)	(")	(cm)	(")	(cm)	(")
15 cm	30	12	25	10	26	10
20 cm	33	13	28	11	28	11
25 cm	39	15	32	13	30	12

<b>(2)</b>	Fluid viscosity : 20 s CA n° 4 ( = 40 centipoises) For HTi + E 5 K HVLP : P 1 = 2 bar / 29 psi For HTi + EP 5 : P 1 = 2,5 bar / 36 psi For HPA + EN 5 : P 1 = 2,5 bar / 36 psi
<b>(3)</b>	Gun aircap distance - surface to be painted : 20 cm / 8"
	Optimum fan adjustment

### M 22 GSP

Air pressure = 6 bar max / max 87 psi

Fluid pressure = 0,5 bar max / max 7.2 psi



The cup is fitted with a safety valve preset to 0,5 bar / 7.2 psi. - Do not throw out of order the safety valve.

If trouble with valve, please, change the cup.



## 4. INSTALLATION

### ■ DESCRIPTION OF THE LABEL MARKING

Marking defined by the ATEX directive

<b>KREMLIN STAINS FRANCE</b>	Name and address of the manufacturer	On the trigger
<b>09</b>	Manufacture year (eg : 09 for 2009)	
 <b>II 2 G</b>	<b>II</b> : group II <b>2</b> : class 2 Surface equipment meant to area where explosive atmospheres due to gas, vapours, mists are liable to appear from time to time in usual operating. <b>G</b> : gas	
<b>P air : 6 bar / 87 psi</b>	Gun air supply maximum pressure	On the body
<b>TYPE xx</b>	Gun version	

### ■ INSTALLATION DIAGRAM

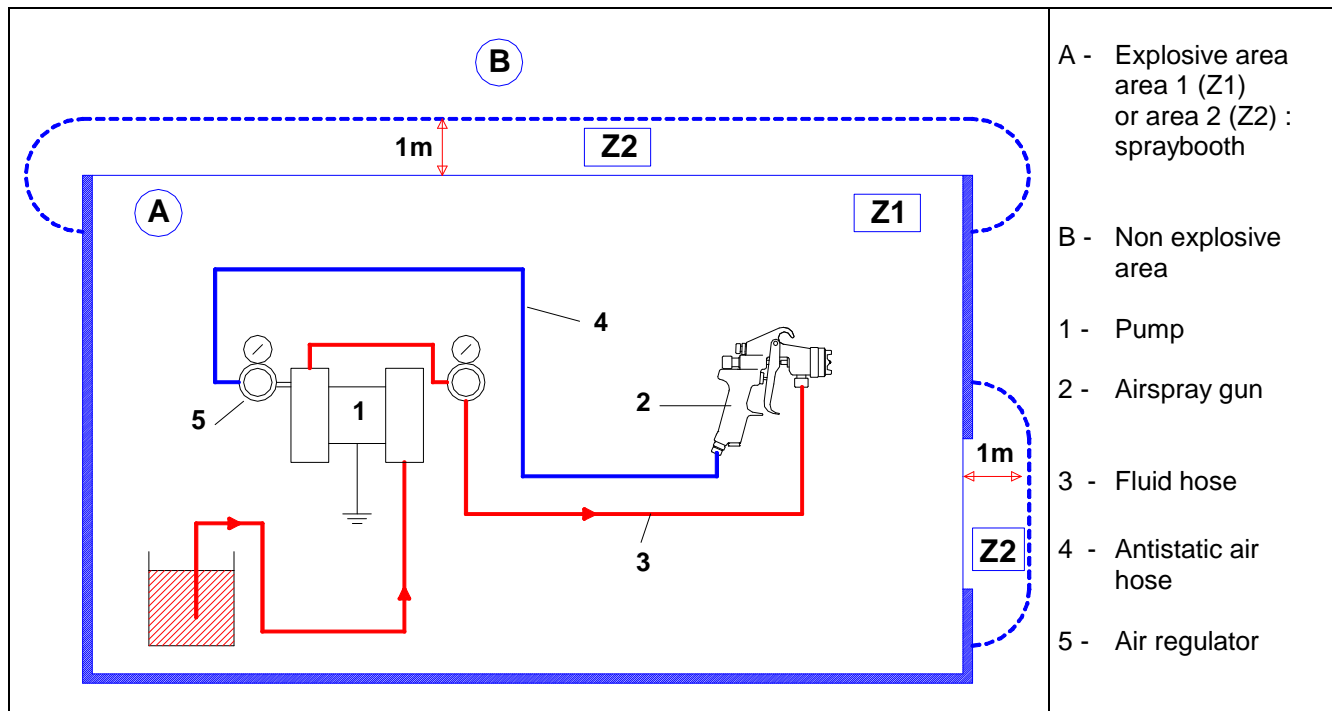

- 1 - By means of a grounded air hose, connect the gun to an air regulator that can supply at least 3 bar / 43.5 psi.
- 2 - By means of a fluid hose, connect the gun fluid fitting to the pump. Tighten firmly the fittings.



Nota : In some particular cases, if the air hose (4) is not conductive, the fluid hose (3) must be conductive.

**One of the 2 gun hoses (air or fluid) must be conductive.**