

SAMES KREMLIN



Airmix® spraying
& equipment



Catalog V5.1

"Creator since 1975, bringing the perfect mix between quality and productivity"

Apply your Skills

www.sames-kremlin.com



Editor's note



In order to help you increase your competitiveness,

SAMES KREMLIN daily dedicates itself to excellence in terms of innovation and reliability.

We constantly improve our performances as well as quality to satisfy your needs.

We also help you define the equipment allowing your

installation to comply with V.O.C. directives. We enable you to benefit from reliable technologies while ensuring you a swift return on investments.

You will find in this catalogue the equipment that will enable you to reach the paint application results you are aiming at.

Providing you with the best, whatever your requirements, is our mission.

All SAMES KREMLIN team is at your disposal to answer your questions.

Enjoy your reading.

NOTES

Area with horizontal dashed lines for taking notes.

Table of contents

PRODUCTS RANGE

AIRMIX® SPRAY GUNS	14
Xcite™ 120 and 200 AIRMIX® gun	14
Xcite™ 400 AIRMIX® gun	16
AIRMIX® tips	18
AUTOMATIC AIRMIX® GUNS	22
AVX Airmix® spray gun - Stainless Steel	22
ATX Airmix® spray gun - Stainless Steel	24
AXC Airmix® spray gun - Stainless Steel	25
AIRMIX® SPRAY GUNS	27
AIRMIX® tips	27
AIRMIX® PUMPS	30
AIRMIX® 10C18 paint pumps	30
AIRMIX® 10C50 paint pump - stainless steel	32
AIRMIX® 15C25 & 15C25 MB-A paint pump - stainless steel	34
AIRMIX® 15C50 paint pump - stainless steel	36
AIRMIX® 16C240 paint pump - stainless steel	38
AIRMIX® 20C50 paint pump - stainless steel	39
AIRMIX® 20C100 paint pump - stainless steel	40
AIRMIX® 30C25 & 30C25 MB-A paint pump - stainless steel	42
AIRMIX® FLOWMAX® PUMPS	44
AIRMIX® 16F240 FLOWMAX® paint pump - stainless steel	44
AIRMIX® 17F60 FLOWMAX® paint pump - stainless steel	46
AIRMIX® 20F50 FLOWMAX® pump - stainless steel	48
AIRMIX® 20F100 FLOWMAX® pump - stainless steel	49
PCS 20F440 FLOWMAX® AIRMIX® paint pump - stainless steel	50
HEATERS	51
HP 60/61 HEATERS	51
AD 60/61 HEATERS ⚠ non explosive	52
One-Pass™ HEATER ⚠ non explosive	53
CTM COLOR CHANGE VALVES	55
PRESSURE REGULATORS	56
FILTRATION	58
AGITATORS	59
Cyclix™ agitators for 20-40-200 l drums	59
HOSES	61
MISCELLANEOUS	63
PROTECTION	64
RC 600 full visor mask	64
RC 756 respirators	65
MECHANICAL DOSING	70
PU 2160 F pump	70
PU 3000 2l and 4l	72
ELECTRONIC DOSING	74
CYCLOMIX™ Micro and Micro+ PH	74
CYCLOMIX™ Multi and Multi PH	75
CYCLOMIX™ Expert	76
FITTINGS AND AIR TREATMENT	80
PRACTICAL	90

CHAPTERS

GENERAL INFORMATION	6
AIRMIX® SPRAYING	13
PLURAL COMPONENT PUMPS AND MACHINES	69
FITTINGS AND AIR TREATMENT	79

Global presence

16 Offices



CANADA
931, Progress Ave, Unit 7
SCARBOROUGH M1G 3V5
Tel.: (00) 141 643 15017
Fax: (00) 141 643 19171



UNITED STATES OF AMERICA
45001 5 Mile Rd.
PLYMOUTH, MI, 48170
Tel.: 734-979-0100
Fax: 734-927-0064

MEXICO
BERNARDO GARZA TREVINO # 1715
COL DE MAESTRO MONTERREY, N.L
CP 64180 MEXICO
Tel.: (81) 1257-1111
Fax: (81) 1352-8316



BRAZIL
Rua Alfredo Mario Pizotti, N.41
Vila Guilherme
SAO PAULO SP
Tel.: (+ 5511) 2903 1200



ARGENTINA
Avenida Juan Justo, 6021
C1416DLB CIUDAD DE BUENOS AIRES
Tel.: +54 11 45 82 89 80
Fax: +54 11 45 84 66 77



HEADQUARTERS
Sames Kremlin



GERMANY
Moselsstrasse 19
D-41464 NEUSS
Tel.: +49 213 13 69 22 00
Fax: +49 213 13 69 22 22

SAMES KREMLIN
Stains

PORTUGAL
Rua da Silveira, 554 - Tauria
2410-269 POUSOS LRA
Tel.: +351 244 848 220
Fax: +351 244 848 229



SPAIN
C/Botánica, 49
08908 L'HOSPITALET DE LLOBREGA
BARCELONA
Tel.: +34.932641540
Fax: + 34.932632829



SOUTH AFRICA
Block G, Hurlingham Office Park, Hurlingham
Johannesburg
Tel: +27 (11) 285 0040



Global presence

RUSSIA

23 Street Radionava Office 21
603093 NIZHNI NOVGOROD
Tel. : 007 831 467 8981



POLAND

Modlinska 221B
03120 - WARSZAWA
Tel. : + 48 225 10 38 50
Fax : + 48 225 10 38 77



ITALIA

Linate Business Park
Strada Provinciale Rivoltana 35
20096 Pioletto (MI)
Tel. : (+39) 02 - 48952815
Fax : (+39) 02 - 48300071



JAPAN

Takashima 2-19-12 - Sky Blig 20F
220-0003 YOKOHAMA - Nishi kanagawa
TEL: 045 412 5800
FAX: 045 412 5801
Mobile: 080 4203 3030



CHINA

Building No.9, No.3802 Shengang Road
Songjiang District
SHANGHAI 201413
Tel. : 021-5438 6060
Fax : 021-5438 6090



INDIA

GAT no - 634, PUNE NAGAR Road, Wagholi
PUNE - 412 207
Tel : +91 20 30472700/01
Fax : +91 20 30472710



SINGAPORE /SOUTH EAST ASIA

German Centre
International Business Park #05-109E
SINGAPORE 609916
Tel. : +65 65628290
Fax : +65 68359096



Office



Application Center

Paint

Decoration and protection are often two associated functions. To achieve these aims, and to re-finish products, we have at our disposal a tremendous number of surface treatments,(for example nickel or chrome plating etc.).

Paint is also perfect for both of these functions. In addition, paint is universally used, and can be applied on any surface, such as wood, metal, stone, leather, plastic and elastomers. Paint does not come as a finished product, and hence the quality of application will depend on all its stages of preparation, which we will call the "Painting System".

In general , the stages are as follows:

- » Surface preparation
- » Application of the coating (paints, stains, varnishes, etc...)
- » Drying

DISCOVER IN THE GENERAL CATALOGUE AND FOR EACH equipment, Recommended paint families, water-based or solvent-based.



WATER-BASED MATERIALS



SOLVENT-BASED MATERIALS



1. PRIMERS



2. STAINS



3. DIRECT GLOSS/METALLIC



4. TOP COATS/HIGH GLOSS



5. UV PRODUCTS



6. MOISTURE-SENSITIVE MATERIALS



7. ANTI-CORROSION - ABRASIVES

SURFACES PREPARATION

There is a wide range of physical and chemical treatments to which the surface to be coated can be subjected, before receiving the first coat.

Good surface preparation is the essential base for long-lasting protection and a good visual finish on any material.

The surface preparation is often the longest, and therefore the most important task involved in coating a part.

Material	Physical preparation	Chemical preparation
Steel:	stripping, shotblasting, brushing	acid
Aluminum:	Brushing	Vapor blast
Wood:	Sanding	
Plastic:	heating	plasma torch, acid

Once treated, the surfaces should be free from:

- » particulate or non-adherent substances
- » oil, grease and moisture

To obtain the best protection against corrosion (mainly for metal), we coat with either:

- » a wash primer or
- » an anti-corrosion paint

A **wash primer** is a liquid product of around 16s Zahn#2, which should be sprayed in a thin coat, to get into all the imperfections in the surface of the metal. The phosphoric acid which it contains attacks the surface of the metal and forms an isolating and impenetrable layer of phosphate. The wash primer is highly valued for its adhesion to the metal. Importantly, it should then be coated with a layer of paint, which plays the role of a protective shield.

An **anti-corrosion** paint is a product which should be sprayed in a thicker layer than the wash primers. Containing anti-corrosive elements, it has the advantage of protecting the metal both physically and chemically at the same time. Also, it saves time, as a single coat applies both the anti-corrosive chemicals and the protective shield to the metal.

These paints are used very frequently on metal framework, as the coating can be left as it is, or covered subsequently with the desired paint finish.



16s CA₄



40s CA₄

Paint

Looking at a painted object will tell us that paint is hard. However, the paint which we spray is a liquid.

This transformation is due in the main part to several components of paint whose functions are described below.

COMPONENTS OF PAINT

Paint contains one or more substances which are generally dissolved in a solvent (or in water) and which regain their solid consistency after drying on the surface.

Amongst these substances, we find:

- » Binders
- » Pigments
- » Fillers

The binder is generally a more or less transparent body which resembles a resin. Dissolved on its own in a solvent it produces a lacquer:

Binder + Solvent = Lacquer

Paint often bears the name of the type of solvent on which it is based (cellulose paint is based on a cellulose solvent). To darken the finish, we add highly colored and very fine powders, which we call pigments:

Binder + Solvent + Pigments = Paint

Dry and wet layer

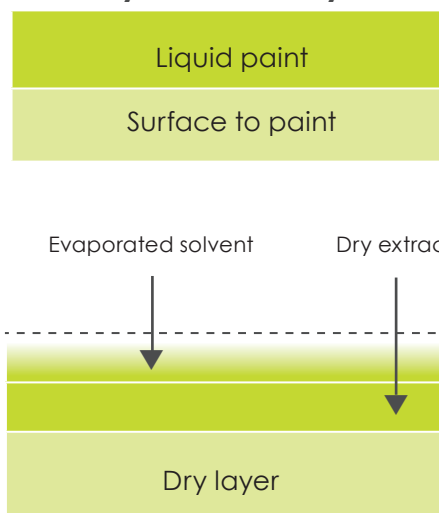

GLOSSARY

» **Sticky film:** we say that a film is sticky when we put a finger on it and it feels like adhesive tape

» **Dust-free film:** we say that the film is dust-free, when any dust which lands on it can be removed by blowing

» **Film that is dry to the touch:** we say that the film is dry to the touch when a finger does not leave a mark on the surface.

» **Finger-nail hard:** we say that the film is finger-nail hard when we cannot mark it. In this state, it can be polished or sanded.

Paint

Finally, to give the finish specific characteristics, we use a whole range of fillers and additives. Solvents make it possible to dissolve the other components of the paint, and can be classed into the following three groups:

» **Fast solvents:** they evaporate extremely quickly, to such an extent that the paint can dry too quickly, not allowing it enough time to adhere correctly to the surface.

These solvents are never used on their own.

» **Slow solvents:** they evaporate very slowly, allowing the paint to adhere properly. They leave a soft and smooth finish.

Slow solvents are not very widely used because they significantly increase the drying time.

» **Medium solvents:** they evaporate in a few seconds; this is enough to ensure good adhesion, while giving a satisfactory drying time.

In order to make the correct paint, the manufacturer first of all makes a list of the solvents capable of dissolving all the binders he wishes to include, and then chooses those with a volatility suitable for the planned method of drying (whether at room-temperature or in an oven). Before application, paint is often reduced to give a consistency which is ideal for the task.

PAINT CONSISTENCY

Viscosity

The consistency of the paint should be adapted for the type of application. It is identified by the extent of its viscosity, which is expressed in centipoises or by measuring the time in seconds that it takes for a certain amount of paint to run through a calibrated viscosity cup. There are different viscosity cups used for measuring the viscosity of paints. The table below shows the relationship between cup size and viscosities in Centipoises.

AFNOR 4 (CA4)	ISO 4	mPas.s	Centipoises	Ford 4 (CF4)	DIN 4 (D°)	CH (Fr)	ZAHN (n°2)
12	-	20	20	10	11	6	18
14	17	25	25	12	12	7	19
16	23	30	30	14	14	-	20
20	34	40	40	18	16	8	22
25	51	50	50	22	20	9	24
29	60	60	60	25	23	10	27
32	68	70	70	28	25	-	30
34	74	80	80	30	26	11	34
37	82	90	90	33	28	12	37
40	93	100	100	35	30	13	41
45	-	120	120	40	34	14	49
50	-	140	140	44	38	15	58
56	-	160	160	50	42	16	66
61	-	180	180	54	45	17	74
66	-	200	200	58	49	18	82
70	-	220	220	62	52	19	-

Nota: 1 poise = 100 centipoises and 1 mPas.s = 1 centipoise (If the density of the paint is equal as 1 and if it is a fluid Newtonien, that is to say no thixotrope).

THE EFFECT OF TEMPERATURE ON VISCOSITY

Viscosity of paint changes with variations in temperature; basically, the resins are far more fluid when they are hot.

The table below shows the changes in viscosity of a glycerophthalic paint as the temperature varies. It is worth noting that a paint which has a viscosity of 22s at 68°F will have a viscosity of 28s at 54°F and of 17s at 90°F.

		Temperatures (°C)																			
		2	4	6	8	10	12	14	16	18	20	22	24	26	28	30	32	34	36	38	40
V I S C O S I T Y I N S E C O N D S C F # 4	27	26	24	23	22	21	21	20	19	18	18	17	17	16	15	15	14	14	14	14	
	33	31	29	27	26	25	23	22	21	20	19	18	18	17	16	16	15	15	14	14	
	39	36	34	32	30	28	26	24	23	22	21	20	19	18	17	17	16	15	15	14	
	46	42	39	36	34	31	29	27	26	24	23	22	21	19	18	17	17	16	15	15	
	54	49	45	41	38	35	32	30	28	26	24	23	21	20	19	18	17	17	16	15	
	56	51	47	43	40	36	33	31	29	27	25	23	21	20	20	19	18	17	16	16	
	61	55	50	46	42	38	35	32	30	28	26	24	22	21	20	19	18	17	16	16	
	69	63	56	52	46	42	39	35	32	30	28	25	24	23	21	20	19	18	17	16	
	77	69	62	55	50	46	41	38	35	32	29	27	25	24	22	21	19	18	17	16	
	84	74	67	61	54	50	44	40	36	34	30	28	26	25	23	22	20	18	17	16	
	95	84	75	66	60	54	48	44	40	36	33	30	28	26	24	22	20	19	18	17	
	104	92	81	73	65	58	52	46	42	38	35	31	29	27	24	23	21	20	19	18	
	112	100	88	76	69	62	54	49	44	40	36	32	30	27	25	23	21	20	19	18	
	122	108	90	85	75	66	59	53	47	42	38	35	31	28	26	24	22	21	19	18	
	132	120	102	90	80	70	63	55	50	44	40	36	33	30	27	25	23	22	20	18	
	142	124	108	95	84	74	65	58	52	46	41	37	34	31	27	25	23	22	20	18	
152	132	119	101	90	80	69	61	54	48	43	38	35	31	28	26	24	23	21	18		
164	140	123	106	94	83	73	64	56	50	45	40	36	32	29	27	24	23	21	18		

Example : at a temperature de 20°C for an announced viscosity of 22 s, you should be ready for the following results:

- ▶ at 12°C, a viscosity of 28 s,
- ▶ at 32°C, a viscosity of 17 s.

Paint

Quality problems tend to arise when the temperature of the paint changes during the course of the day. For example: During the course of this day, the viscosity of the paint has moved from 23 to 17 seconds, which leads to a 22% increase in the output of the spray guns, leading to over-coloring and excessive product consumption.

	Temperatures (°C)	Viscosity - CA4 (seconds)	Spray gun output (cm ³ /mm)
morning, cool workshops	15	23	460
Later - workshop heats up	20	20	520
An oven switched on	25	17	560

Worse still, paint prepared in a hot workshop at 20 seconds can be at 28 seconds the following morning, before the workshop has got up to full working temperature: this would lead to a less fine spray and a much greater drying time.

DRYING OF PAINTS

the component of paint can be classed in two groups:

» Dry extracts

» VOC (Volatile organic compounds), or water in case of water-based paints

Drying paint is all about allowing the volatile products to evaporate and the film to harden. We must distinguish between hardening and drying.

Drying gives us the dry film purely by the evaporation of the volatile products. This happens at two stages: during spraying and within the film. Depending on the temperature, the density of the spray, the type of spray gun and the distance of the spray, the paint can arrive on the surface more or less dry. That means that the majority of the solvent has evaporated before the paint reaches the surface. The drying of the wet film is accelerated when the surface is in a well-ventilated area which has dry air and is dust-free.

NOTES

Area with horizontal dashed lines for taking notes.

AIRMIX® SPRAYING

Airmix® spraying

Plural component pumps and machines

Fittings and air treatment

Xcite™ 120 and 200 AIRMIX® gun



+/- 2% according to norm (EN 13966-1)

86%*
TRANSFER EFFICIENCY
 HVLV COMPLIANT

New Sensations for New Performances

The Xcite™ gun is the result of Sames Kremlin experience since 1925. The Xcite™ gun brings an excellent comfort to the operator. Its ultra light trigger, its design, its ergonomics and its swivel fitting reduce the operator fatigue, improve the productivity and stop all risks of RSI (Repetitive strains injuries)

The new Xcite™ gun uses high quality components which ensure a perfect reliability maintaining a high level of performances. The last generation of Airmix® atomization aircap offers unsurpassed finish quality.

The sprayer has the ability to significantly vary the pattern without changing the tip while using minimum atomization air and pressure. It's really useful when painting complex shape parts.

FEATURES

- Ergonomic design and light trigger
- Product swivel fitting
- Product fluid passages in stainless steel
- Nickel brass air needle
- Large and fine fan width adjustment

BENEFITS

- Reduced fatigue and excellent working conditions for increased productivity
- Compatible with water-based materials
- Long service life and good reliability
- Ability to adjust the fan width to the shape of the part to be painted leads to higher efficiency and productivity
- Outstanding spraying quality with reduced overspray
- Simple using

- Increased atomization quality
- Increased transfer efficiency
- E-Z adjust aircap

SPECIFICATIONS

Sprayed materials	Polyurethanes, water-based products, high solids, two-components products, stains, lacquers, varnishes, etc.	
Body of the gun	Forged aluminum	
Fluid Pressure Range Xcite™ 120 (bar)	20 - 120	
Fluid Pressure Range Xcite™ 200 (bar)	20 - 200	
Maximum air inlet pressure (bar)	6	
Recommended atomization air pressure (bar)	0.7 - 3	
Fluid output (l/mn)	Depends on the tip used	
Weigh	construction without fluid swivel fitting (g)	511
	construction with fluid swivel fitting (g)	579
Maximum Fluid Temperature (°C)	50	
Air consumption (m³/h)	3.2 - 7.5	
Wetted parts	Stainless steel, PTFE, carbide	
Safety	Trigger lock	
Filter (fitted on fluid tube)	#6 - 85 mesh/ 168µ	
Seat	120 bar (stainless steel)	
	200 bar (carbide)	

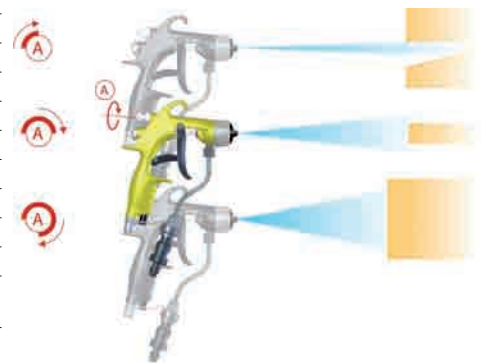

FITTINGS

Fitting	Air Inlet	M 1/4 NPS
Swivel fitting	Fluid Inlet	M 1/2" JIC

Xcite™ 120 and 200 AIRMIX® gun

AIRCAP VX 24 KHVLP

CONFIGURATION OF THE XCITE™ SPRAY GUN WITH AIRCAP AND FLUID SWIVEL FITTING

Gun type	Aircap	Tip	Maximum fluid pressure (bar)	Seat	Part number
Xcite™ 120	VX 24 KHVLP	To be ordered separately (see table page 18)	120	Stainless steel	135.720.100
Xcite™ 200	VX 24 KHVLP	To be ordered separately (see table page 18)	200	Carbide	135.720.200

AIRCAP VX 24 KHVLP

CONFIGURATION OF THE XCITE™ SPRAY GUN WITH AIRCAP WITHOUT FLUID SWIVEL FITTING

Gun type	Aircap	Tip	Maximum fluid pressure (bar)	Seat	Part number
Xcite™ 120	VX 24 KHVLP	To be ordered separately (see table page 18)	120	Stainless steel	135.720.120
Xcite™ 200	VX 24 KHVLP	To be ordered separately (see table page 18)	200	Carbide	135.720.220

See also on page 17 for aircaps part numbers

SEAL KITS

Description	Part number
Seal kit for Xcite™ gun (fluid)	129.729.901
Seal kit for Xcite™ gun (air)	129.729.908
Repair kit for Xcite™ 120 gun (seal kits included)	129.729.920
Repair kit for Xcite™ 200 gun (seal kits included)	129.729.921

OLD GENERATION SEAL KITS

Description	Part number
Seal kit for MVX spray gun	129.679.901
Repair kit for MVX spray gun (seal kit included)	129.679.902



XCITE™ KITS WITH AIR AND FLUID HOSES

Description	Aircap		Tip	Diameter		Hoses Length (m)	Kit part number
	Type			Fluid hose (mm)	Conductive air hose (mm)		
Xcite™ 120	VX 24 K HVLP		To be ordered separately (see table page 18)	4.8	7	7.5	151.260.960
Xcite™ 200	VX 24 K HVLP		To be ordered separately (see table page 18)	4.8	7	7.5	151.260.961

AIRMIX® 40C50 PAINT PUMPS KIT WITH SWIVEL FITTING AIRMIX® XCITE™ GUN



Kit designation	Gun type	Supplied with aircap	Tip	Suction rod (Ø 25)	Drain rod	Atomization air regulator	Hoses Length (m)	AD60 Heater	Pump output filter	Kit part number
Wall-mounted Kit	Xcite™ 200	VX24	To be ordered separately (see table page 18)	●	●	●	7.5	-	●	151.260.968
Hot spraying wall-mounted Kit	Xcite™ 200	VX24	To be ordered separately (see table page 18)	●	●	●	7.5	●	●	151.260.969

AIRMIX® 34F60 FLOWMAX® PAINT PUMP KITS WITH SWIVEL FITTING XCITE™ GUN



Kit designation	Gun type	Supplied with aircap	Tip	Suction rod (Ø 25)	Drain rod	Atomization air regulator	Hoses Length (m)	Pump output filter	Kit part number
Wall-mounted stainless steel	Xcite™ 200	VX24	To be ordered separately (see table page 18)	●	●	●	7.5	●	151.260.970

Xcite™ 400 AIRMIX® gun

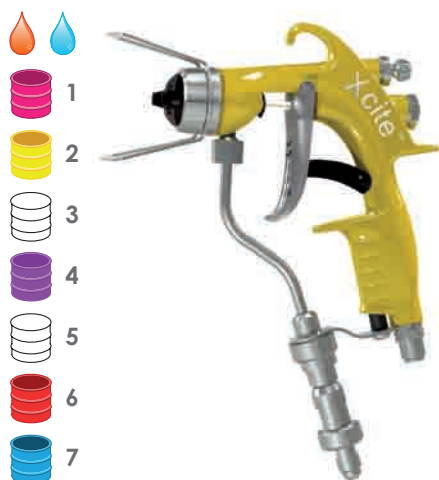

New Sensations for New Performances

The Xcite™ gun is the result of Sames Kremlin experience since 1925. The Xcite™ gun brings an excellent comfort to the operator. Its ultra light trigger, its design, its ergonomics and its swivel fitting reduce the operator fatigue, improve the productivity and stop all risks of RSI (Repetitive strains injuries)

The new Xcite™ 400 gun uses high quality components which ensure a perfect reliability maintaining a high level of performances. The Xcite™ 400 is dedicated to apply single component adhesives and sealants, MS polymers, water-based adhesives, greases, waxes and a large range of thick materials requiring an atomization pressure higher than 200 bar.

The sprayer has the ability to significantly vary the pattern without changing the tip while using minimum atomization air and pressure. It's really useful when painting complex shape parts.

FEATURES

- Ergonomic design and light trigger
- Product swivel fitting
- Product fluid passages in stainless steel
- Nickel brass air needle
- Large and fine fan width adjustment

BENEFITS

- Reduced fatigue and excellent working conditions for increased productivity
- Compatible with water-based materials
- Long service life and good reliability
- Ability to adjust the fan width to the shape of the part to be painted leads to higher efficiency and productivity
- Outstanding spraying quality with reduced overspray
- Simple using

SPECIFICATIONS

Sprayed materials	Single component adhesives and sealants, MS polymers, water-based adhesives, greases, waxes and a large range of thick materials, etc...
Body of the gun	Forged aluminum
Fluid Pressure Range (bar)	200 -400
Maximum air inlet pressure (bar)	6
Recommended atomization air pressure (bar)	0,7 - 3
Fluid output (l/mn)	Depends on the tip used
Weight construction with fluid swivel fitting (g)	587
Maximum Fluid Temperature (°C)	50
Air consumption (m3/h)	3,2 - 7,5
Wetted parts	Stainless steel, PTFE, carbide
Safety	Trigger lock
Filter (fitted on fluid tube)	#6 - 85 mesh/ 168µ
Seat	Carbide

FITTINGS

Fitting	Air Inlet	M 1/4 NPS
Swivel fitting	Fluid Inlet	M 1/2" JIC

Xcite™ 400 AIRMIX® gun

VX 24 KHVLP AIRCAP

CONFIGURATION OF THE XCITE™ SPRAY GUN WITH AIRCAP AND FLUID SWIVEL FITTING

Gun type	Aircap with hand protection guard	Tip	Maximum fluid pressure (bar)	Seat	Part number
Xcite™ 400	VX 24 KHVLP	To be ordered separately (see table page 18)	400	Carbide	135.720.400

SEAL KITS

Description	Part number
Seal kit for Xcite™ 400 gun (product)	129.729.941
Seal kit for Xcite™ gun (air)	129.729.908
Maintenance kit for Xcite™ gun (including seal kits)	129.729.943

XCITE™ WHIP END HOSES KITS

Description	Diameter Fluid hose (mm)	Maximum fluid pressure (bar)	Hoses Length (m)	Kit part number
Whip end PTFE fittings 2 x F 1/2" JIC	6	500	1	050.457.301 ⁽¹⁾
Whip end PTFE fittings 2 x F 1/2" JIC	6	500	1,5	050.457.302 ⁽¹⁾

(1) To be ordered 1/2" JIC male/male fitting # 050.102.301 for high pressure hoses

AIRCAPS FOR AIRMIX® SPRAY GUNS

AIRCAP FOR XCITE™ 120 AND 200 WITHOUT TIP PROTECTION SPRAY GUN

	VX24 KHVLP
	
For XCITE™ spray guns	132.720.020
Adjustable fan	●
Spraying quality	Excellent
Transfer efficiency	Excellent
Non-stick coating	-

AIRCAP FOR XCITE™ 120, 200 AND 400 WITH TIP PROTECTION SPRAY GUN

	VX24 KHVLP
	
For XCITE™ spray guns	132.720.420
Adjustable fan	●
Spraying quality	Excellent
Transfer efficiency	Excellent
Non-stick coating	-

AIRMIX® tips



The choice of the tip must be done according to the desired flowrate in order to achieve a good finish and reduce paint costs. An AIRMIX® tip needs to be replaced frequently in order to maintain the original transfer efficiency.

To order a tip, replace the «x» characters in the table, by the chosen tip number in 134.5xx.xx4 for a Fine Finish or 134.5xx.xx2 for an Xtra™ Fine Finish tip, recommended for water-based materials or for an increased atomization quality due to the pre-atomization. (For example: order 134.509.094 (Fine Finish) or 134.509.092 (Xtra™ Fine Finish) if choosing a 09.09 tip)(only 100.21 tip has part number 134.100.214).

TABLE OF FINE FINISH TIPS

Caliber	(mm)	Water output (l/mn)	Water output (l/mn)	Water output (l/mn)	Water output (l/mn)	Screen marking for filter	Marking on pump filter	Average width of fan (cm) at a distance of 25cm*											
		Pressure (bar)	Pressure (bar)	Pressure (bar)	Pressure (bar)			Gun	Pump	9	12	17	21	25	29	33	37	44	56
02	0.15	0.07	0.10	0.13	0.17	4	2	02.03	02.05					02.11					
03	0.18	0.11	0.15	0.20	0.26	4	2	03.03	03.05	03.07					03.13				
04	0.23	0.16	0.22	0.29	0.38	4	2 or 4	04.03	04.05	04.07	04.09	04.11	04.13						
06	0.28	0.23	0.33	0.43	0.57	4	4 or 6	06.03	06.05	06.07	06.09	06.11	06.13	06.15					
07	0.30	0.28	0.39	0.51	0.66	6	4 or 6							07.15					
09	0.33	0.32	0.45	0.59	0.77	6	6 or 8	09.03	09.05	09.07	09.09	09.11	09.13	09.15	09.17				
12	0.38	0.42	0.60	0.79	1.03	6	8 or 12			12.07	12.09	12.11	12.13	12.15	12.17				
14	0.41	0.51	0.72	0.94	1.23	12	8 or 12		14.05	14.07	14.09	14.11	14.13	14.15	14.17				
18	0.48	0.67	0.95	1.24	1.63	12	12						18.13	18.15	18.17	18.19			
20	0.50	0.75	1.06	1.39	1.82	12	12			20.07	20.09	20.11	20.13	20.15	20.17	20.19			
25	0.56	0.94	1.33	1.74	2.28	12	15						25.13		25.17				
30	0.61	1.13	1.60	2.09	2.74	12	15					30.11	30.13	30.15	30.17	30.19			
40	0.72	1.54	2.18	2.85	3.73	12	20								40.17				
45	0.76	1.68	2.38	3.12	4.08	12	20					45.11		45.15	45.17	45.19			
100	1.04	3.96	5.68	7.33	9.47	12	20 - 30									100.17			100.21

TABLE OF XTRA™ FINE FINISH TIP

Caliber	(mm)	Water output (l/mn)	Water output (l/mn)	Water output (l/mn)	Water output (l/mn)	Screen marking for filter	Marking on pump filter	Average width of fan (cm) at a distance of 25cm*											
		Pressure (bar)	Pressure (bar)	Pressure (bar)	Pressure (bar)			Gun	Pump	9	12	17	21	25	29	33	37		
04	0.23	0.16	0.22	0.29	0.38	4	2 or 4	04.03	04.05	04.07	04.09	04.11	04.13						
06	0.28	0.23	0.33	0.43	0.57	4	4 or 6	06.03	06.05	06.07	06.09	06.11	06.13	06.15					
07	0.30	0.28	0.39	0.51	0.66	6	4 or 6							07.15					
09	0.33	0.32	0.45	0.59	0.77	6	6 or 8	09.03	09.05	09.07	09.09	09.11	09.13	09.15					
12	0.38	0.42	0.60	0.79	1.03	6	8 or 12			12.07	12.09	12.11	12.13	12.15	12.17				
14	0.41	0.51	0.72	0.94	1.23	12	8 or 12		14.05	14.07	14.09	14.11	14.13	14.15	14.17				

*Measured with water at 70 bar.

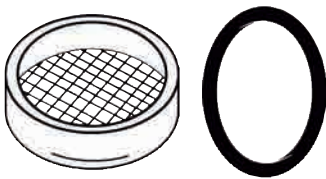

MICROSCREENS AND TIP SEALS

PART NUMBERS

Tip size	Microscreen (99 µ) (pack of 10)	PTFE O'ring seals (pack of 10)
02-03-04-06	129.609.901	-
09 and above	-	129.529.903

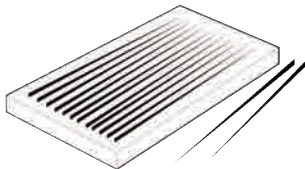

TIP CLEANING NEEDLES

PART NUMBERS

Description	Nozzles Size (mm)	Quantity	Part number
Unclogging needles	≤ 0.9	12	000.094.000
Unplugging needles	≥ 0.9	12	000.094.002



SEATS FOR SPRAY GUNS

SEATS FOR XCITE™ SPRAY GUNS

Type	Quantity	Part number
Polyacetal	10	129.729.904
Stainless steel with seal (120 bar)	2	129.679.905
Carbide with seal (200 bar)	2	129.679.906
Carbide with seal (400 bar)	2	129.729.907

SEATS FOR MVX SPRAY GUNS

Type	Quantity	Part number
Polyacetal	10	129.679.904
Stainless steel with seal (120 bar)	2	129.679.905
Carbide with seal (200 bar)	2	129.679.906

SEAL KIT FOR AIRMIX® GUNS

Description	Quantity	Part number
Seals for stainless steel or carbide seats	10	129.629.922

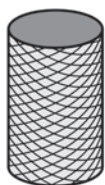

GUN FLUID FILTER SCREEN

PART NUMBERS

Stainless steel screen for filter	Size (µ)	Quantity	Part number
N° 4	100	5	129.609.907
N° 6 (mounted on the gun)	168	5	129.609.908
N° 12	280	5	129.609.909



ADJUSTING NEEDLES VALVES

For air adjustment at the gun inlet.

ADJUSTING NEEDLE VALVES

Description	Part number
Adjusting needle for Xcite™, MVX, MXLT (MF 1/4") spray guns	050.070.190



EXTENSIONS FOR AIRMIX® SPRAY GUNS

AIRMIX® spray guns can be fitted with extensions in order to spray inaccessible areas.

EXTENSIONS FOR XCITE™ 120 BAR SPRAY GUNS

Description	Length in mm	Part number
Straight extension	400	075.810.010

EXTENSIONS FOR MVX SPRAY GUNS

Description	Length in mm	Part number
Straight extension	400	075.800.012
Elbow extension (45° angle)	250	075.850.011

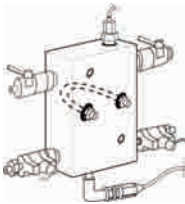

ADAPTOR TO FEED TWO OR THREE GUNS

To supply 2 guns with air and solvent-based paint including shut-off valves and an extra-port to fit a third gun (non stainless steel construction).

ADAPTOR TO FEED TWO OR THREE GUNS

Description	Part number
Adaptor divider	051.319.905



Y-FITTING FOR ONE ADDITIONAL GUN SUPPLY

Fluid circuit: remove the plug of the second fluid filter outlet and connect the elbow fitting.

Air circuit: add the Y-fitting to the outlet of the air regulator on the pump.

TWO-GUN SYSTEM

Description	Material	Part number
Air Y-fitting 1/4" NPS	Stainless steel	129.029.920
Elbow fitting 3/8" NPT - 1/2" JIC to fit on the second fluid filter outlet	Stainless steel	905.210.603

NOTES

Area with horizontal dashed lines for taking notes.

Airmix® spraying

Plural component pumps and machines

Fittings and air treatment

AVX Airmix® spray gun - Stainless Steel



±1-2% according to norm (EN 13966-1)

Light AIRMIX® technology - Modular design for High Volume Production.

The AVX Airmix® gun, thanks to its size and reduced weight increase the performances and the efficiency of the automatic machines.

The atomization quality offered by last generation aircaps and tips guarantees a finish quality and very important product savings.

The fluid circulation is available in the base (no pressure loss) or inside the gun (quick flushing).



FEATURES

- Light AIRMIX® technology: Reduced size and weight
- Excellent atomization quality with outstanding transfer efficiency
- Stainless steel design
- Choice of circulation in the base or the gun
- Choice of bases with rear or side connections
- Choice of tips for water-based materials
- Adjusting fan width kit as an option

BENEFITS

- Optimal application performances
- Excellent finish quality, reduced paint costs, cleaner working environment, lower booth maintenance
- Compatible with water-based materials
- Performance level guaranteed for most materials and easy flushing
- To fit each customer need
- The design of the gun optimizes performances and even flow. Dedicated tips (Xtra™ Fine Finish) optimizes application performances
- To benefit from large possibilities of fan or flowrate adjustment

SPECIFICATIONS

Maximum air inlet pressure (bar)	6
Maximum fluid pressure (bar)	200
Trigger air pressure (bar mini)	3
Recommended atomization air pressure (bar)	0.7 - 3
Fluid output (cc/mn)	Upon tip (see Airmix® table page 27)
Weight (g) (gun only)	452
Maximum Fluid Temperature (°C)	50
Air consumption (m³/h)	3 - 7.5
Wetted parts	Stainless steel - treated stainless steel
Seat	Comes in stainless steel, carbide or polyacetal as an option

FITTINGS

Power supply	Gun base	Fittings supplied, non fitted
Fluid	F 1/4" NPS	M 1/2 JIC - blue Airmix® hose, Ø 4.8 or 6,35 mm
Atomization air	F 1/4" NPS	M 1/4" NPS - air hose Ø 7 int
Pilot air	F 1/8" NPS	Quick fittings - polyamide hose Ø 4x6

AVX Airmix® spray gun - Stainless Steel

CONFIGURATION OF THE AVX GUN FITTED WITHOUT BASE

Description	Version	Aircap	Tip	Part number
AVX gun (L)	circulation in the base	(1)	(1)	129.690.000
AVX gun (Ω)	circulation in the gun	(1)	(1)	129.691.000

CONFIGURATION OF THE AVX GUN FITTED WITH BASE

Description	Base type	Version	Aircap	Tip	Part number
AVX gun (L)	side outputs	circulation in the base	(1)	(1)	129.695.000
AVX gun (Ω)	side outputs	circulation in the gun	(1)	(1)	129.695.100
AVX gun (L)	rear outputs	circulation in the base	(1)	(1)	129.695.050
AVX gun (Ω)	rear outputs	circulation in the gun	(1)	(1)	129.695.150
AVX gun (L) for CEFLA machines	side outputs	circulation in the base	(1)	(1)	129.695.200

(1) To be ordered separately - see table pages 26-27)

KITS

Description	Part number
AVX seal kit (air and fluid)	129.690.901

BASES FOR THE AVX GUN

Description	Base type	Weight (g)	Wetted parts	Part number
Base for AVX (circulation in the base (L))		240		129.690.070
CEFLA Base for AVX (circulation in the base (L))	side outlet	240	stainless steel	129.690.090
Base for AVX (circulation in the gun (Ω))		240		129.691.070
Base for AVX (circulation in the base (L))				129.690.080
Base for AVX (circulation in the gun (Ω))	rear outlet	480	stainless steel	129.691.080

FITTING KITS

Description	Part number
Fitting kit for side outlet base	129.690.075
Fitting kit for rear outlet base	129.690.085

SUPPORTS

Description	Part number
Mounting support Ø 16	049.351.000
Mounting support Ø 12	049.351.700
Adjustable mounting support for Ø12 support	049.351.705

KIT

Description	Part number
Remote adjusting fan width kit	029.253.002

ATX Airmix® spray gun - Stainless Steel



The ATX Airmix® gun, with its unsurpassed quality of atomization provides high finish quality and important product savings. Worldwide recognized by professionals, ATX automatic guns are widely used in automatic finishing lines in most markets.

The fluid circulation is available in the base (no pressure loss) or inside the gun (quick flushing).

FEATURES

Excellent atomization quality with outstanding transfer efficiency

Modular design

Stainless steel design

BENEFITS

Excellent finish quality, reduced paint costs, cleaner working environment, lower booth maintenance

Quick service: only 4 bolts to unscrew, no need to remove hoses

Compatible with water-based materials

SPECIFICATIONS

Maximum air inlet pressure (bar)	6
Maximum fluid pressure (bar)	200
Trigger air pressure (bar mini)	3
Recommended atomization air pressure (bar)	1 - 3
Fluid output (cc/mn)	Upon tip (see Airmix® table page 27)
Weight (g) (gun only)	750
Maximum Fluid Temperature (°C)	50
Air consumption (m³/h)	3 - 7.5
Wetted parts	Stainless steel - treated stainless steel
Seat	Stainless steel

FITTINGS

Power supply	Gun base	Fittings supplied, non fitted
Fluid	F 1/4" NPS	Elbow M 1/4" NPT - M 1/2 JIC
Atomization air	F 1/4" NPS	M 1/8" BSP - 4x6 hose
Pilot air	F 1/8" NPS	M 1/4" BSP - M 1/4" NPS

CONFIGURATION OF THE ATX GUN FITTED WITHOUT BASE

Description	Version	Aircap	Nozzle	Part number
ATX gun (⊥)	circulation in the base	(1)	(1)	129.625.000
ATX gun (Ω)	circulation in the gun	(1)	(1)	129.626.505

(1) To be ordered separately - see table pages 26-27

BASE FOR ATX GUN

Description	Base type	Weight (g)	Wetted parts	Part number
ATX base (circulation in the base (⊥))				129.260.360
ATX base (circulation in the gun (Ω))	side outlet	310	stainless steel	129.626.510

KITS

Description	Part number
ATX seal kit (air and fluid)	129.251.995
Support and screen n°2 kit (x 2)	129.629.906
Support and screen n°4 kit (x 2)	129.629.905
Support and screen n°6 kit (x 2)	129.629.907
Support and screen n°8 kit (x 2)	129.629.916

SUPPORTS

Description	Part number
Mounting support Ø 16	049.351.000
Mounting support Ø 12	049.351.700
Adjustable mounting support for Ø12 support	049.351.705

KIT

Description	Part number
Remote adjusting fan width kit	029.253.002

AXC Airmix® spray gun - Stainless Steel



Compact AIRMIX® technology - reduced size.

The AXC Airmix® gun, thanks to its ultra-compact size and very reduced weight increases the performances and the efficiency of the automatic machines.

Large dimension fluid passages allow to handle a wide range of materials.

The atomization quality offered by last generation aircaps and tips guarantees a finish quality and very important product savings.

FEATURES

Compact Airmix® technologie - reduced size and weight

Excellent atomization quality with outstanding transfer efficiency

Stainless steel design

Choice of tips for water-based materials

Adjusting fan width kit as an option

BENEFITS

Optimal application performances

Excellent finish quality, reduced paint costs, cleaner working environment, lower booth maintenance

Compatible with water-based materials

The design of the gun optimizes performances and even flow. Dedicated tips (Xtra™ Fine Finish) optimizes application performances

To benefit from large possibilities of fan or flowrate adjustment

SPECIFICATIONS

Maximum air inlet pressure (bar)	6
Maximum fluid pressure (bar)	200
Trigger air pressure (bar mini)	3
Recommended atomization air pressure (bar)	1 - 3
Fluid output (cc/mn)	Upon tip (see Airmix® table page 27)
Weight (g) (gun only)	472
Maximum Fluid Temperature (°C)	50
Air consumption (m³/h)	3 - 7.5
Wetted parts	Stainless steel - treated stainless steel
Seat	Comes in stainless steel, carbide or polyacetal as an option

FITTINGS

Power supply	Fittings supplied, non fitted
Fluid	M 1/2 JIC - blue Airmix® hose, Ø 4,8 or 6,35 mm
Atomization air	Quick fittings - polyamide hose Ø 6x8
Pilot air	Quick fittings - polyamide hose Ø 4x6

CONFIGURATION OF THE AXC GUN

Description	Aircap	Nozzle	Part number
AXC gun w/o tip nor aircap and w/o Air Fittings	(1)	(1)	129.697.000

(1) To be ordered separately - see table pages 26-27

KITS

Description	Part number
AXC seal kit (air and fluid)	129.697.901
Air inlet fitting kit	129.697.902

SUPPORTS

Description	Part number
Mounting support Ø 16	049.351.000

KITS

Description	Part number
Remote adjusting fan kit	129.697.250
Stainless steel Y-fitting - for AIRMIX® guns	029.520.500



AIRCAPS FOR AIRMIX® AVX, AXC AND ATX

AVX AIRCAPS FOR WATER-BASED MATERIALS

	VX124 KHVLP - Xcite® type ring	VX124 KHVLP - MVX type ring	VX24 KHVLP - Xcite® type ring
			
For AVX spray guns	132.720.055	132.720.065	132.720.020 ⁽¹⁾
Adjustable fan	-	-	●
Spraying quality	Excellent	Excellent	Excellent
Transfer efficiency	Excellent	Excellent	Excellent
Non-corrosion coating	●	●	●
Non-stick coating	-	-	-



(1) To be used with the remote fan width adjustment kit

AVX AND AXC AIRCAPS FOR SOLVENT-BASED MATERIALS

	VX114 KHVLP	VX14 KHVLP	VX54
			
For AVX/AXC spray guns	132.670.940	132.670.920 ⁽¹⁾	132.670.030
Adjustable fan	-	●	-
Spraying quality	Excellent	Excellent	Good
Transfer efficiency	Very good	Very good	Very good
Non-corrosion coating	-	-	-
Non-stick coating	-	-	●

(1) To be used with the remote fan width adjustment kit

AIRCAPS FOR ATX SPRAY GUNS

	BX116	BX16	BX 56
			
ATX gun	132.650.550	132.650.450 ⁽¹⁾	132.650.300
Adjustable fan	-	●	-
Spraying quality	Excellent	Excellent	Good
Transfer efficiency	Good	Good	Very good
Non-corrosion coating	-	-	-
Non-stick coating	-	-	●

(1) To be used with the remote fan width adjustment kit

AIRMIX® tips



The choice of the tip must be done according to the desired flowrate in order to achieve a good finish and reduce paint costs. An AIRMIX® tip needs to be replaced frequently in order to maintain the original transfer efficiency.

To order a tip, replace the «x» characters in the table, by the chosen tip number in 134.5xx.xx4 for a Fine Finish or 134.5xx.xx2 for an Xtra™ Fine Finish tip, recommended for water-based materials or for an increased atomization quality due to the pre-atomization.

To order the asymmetrical fine finish tip (70/30), designed for applications on rotating surfaces (drum cover, steel wheels), replace the «x» character in the table in 134.5xx.xx7.

(For example: order 134.509.094 (Fine Finish), 134.509.092 (Xtra™ Fine Finish) or 134.509.097 (Fine Finish asymmetrical fan) if choosing a 09.09 tip)(only 100.17 and 100.21 tip have part number 134.100.174 and 134.100.214).

TABLE OF FINE FINISH TIPS

Caliber	(mm)	Water output (l/mn)	Water output (l/mn)	Water output (l/mn)	Water output (l/mn)	Screen marking for filter	Marking on pump filter	Average width of fan (cm) at a distance of 25cm*											
		Pressure (bar)	Pressure (bar)	Pressure (bar)	Pressure (bar)			Gun	Pump	9	12	17	21	25	29	33	37	44	56
02	0.15	0.07	0.10	0.13	0.17	4	2	02.03	02.05					02.11					
03	0.18	0.11	0.15	0.20	0.26	4	2	03.03	03.05	03.07				03.13					
04	0.23	0.16	0.22	0.29	0.38	4	2 or 4	04.03	04.05	04.07	04.09	04.11	04.13						
06	0.28	0.23	0.33	0.43	0.57	4	4 or 6	06.03	06.05	06.07	06.09	06.11	06.13	06.15					
07	0.30	0.28	0.39	0.51	0.66	6	4 or 6						07.15						
09	0.33	0.32	0.45	0.59	0.77	6	6 or 8	09.03	09.05	09.07	09.09	09.11	09.13	09.15	09.17				
12	0.38	0.42	0.60	0.79	1.03	6	8 or 12			12.07	12.09	12.11	12.13	12.15	12.17				
14	0.41	0.51	0.72	0.94	1.23	12	8 or 12	14.05	14.07	14.09	14.11	14.13	14.15	14.17					
18	0.48	0.67	0.95	1.24	1.63	12	12					18.13	18.15	18.17	18.19				
20	0.50	0.75	1.06	1.39	1.82	12	12			20.07	20.09	20.11	20.13	20.15	20.17	20.19			
25	0.56	0.94	1.33	1.74	2.28	12	15					25.13	25.17	25.19					
30	0.61	1.13	1.60	2.09	2.74	12	15					30.11	30.13	30.15	30.17	30.19			
40	0.72	1.54	2.18	2.85	3.73	12	20							40.17					
45	0.76	1.68	2.38	3.12	4.08	12	20					45.11	45.15	45.17	45.19				
100	1.04	3.96	5.68	7.33	9.47	12	20 - 30									100.17			100.21

TABLE OF XTRA™ FINE FINISH TIP

Caliber	(mm)	Water output (l/mn)	Water output (l/mn)	Water output (l/mn)	Water output (l/mn)	Screen marking for filter	Marking on pump filter	Average width of fan (cm) at a distance of 25cm*											
		Pressure (bar)	Pressure (bar)	Pressure (bar)	Pressure (bar)			Gun	Pump	9	12	17	21	25	29	33	37		
04	0.23	0.16	0.22	0.29	0.38	4	2 or 4	04.03	04.05	04.07	04.09	04.11	04.13						
06	0.28	0.23	0.33	0.43	0.57	4	4 or 6	06.03	06.05	06.07	06.09	06.11	06.13	06.15					
07	0.30	0.28	0.39	0.51	0.66	6	4 or 6						07.15						
09	0.33	0.32	0.45	0.59	0.77	6	6 or 8	09.03	09.05	09.07	09.09	09.11	09.13	09.15					
12	0.38	0.42	0.60	0.79	1.03	6	8 or 12			12.07	12.09	12.11	12.13	12.15	12.17				
14	0.41	0.51	0.72	0.94	1.23	12	8 or 12	14.05	14.07	14.09	14.11	14.13	14.15	14.17					

TABLE OF FINE FINISH TIP (ASYMMETRICAL FAN PATTERN)

Caliber	(mm)	Water output (l/mn)	Water output (l/mn)	Water output (l/mn)	Water output (l/mn)	Screen marking for filter	Marking on pump filter	Average width of fan (cm) at a distance of 25cm*											
		Pressure (bar)	Pressure (bar)	Pressure (bar)	Pressure (bar)			Gun	Pump	9	12	17	21	25	29	33	37		
06	0.28	0.23	0.33	0.43	0.57	4	4 or 6					06.09	06.11						
09	0.33	0.32	0.45	0.59	0.77	6	6 or 8					09.09	09.11						
12	0.38	0.42	0.60	0.79	1.03	6	8 or 12					12.09	12.11						
14	0.41	0.51	0.72	0.94	1.23	12	8 or 12					14.09	14.11						

*Measured with water at 70 bar

Accessories for AIRMIX® spray guns

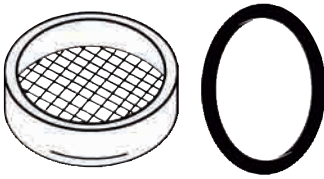

MICROSCREENS AND TIP SEALS

PART NUMBERS

Tip size	Microscreen (99 µ) (pack of 10)	PTFE O'ring seals (pack of 10)
02-03-04-06	129.609.901	-
09 and above	-	129.529.903

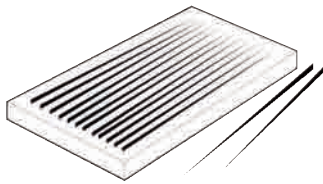

TIP CLEANING NEEDLES

PART NUMBERS

Description	Nozzles Size (mm)	Quantity	Part number
Unclogging needles	≤ 0.9	12	000.094.000
Unclogging needles	≥ 0.9	12	000.094.002



SEATS FOR AUTOMATIC SPRAY GUNS

SEATS FOR AVX AND AXC

Type	Quantity	Part number
Polyacetal	10	129.679.904
Stainless steel with seal	2	129.679.905
Carbide with seal	2	129.679.906

SEATS FOR ATX SPRAY GUNS

Type	Quantity	Part number
Polyacetal	10	129.609.911
Stainless steel with seal	2	129.629.923
Carbide with seal	2	129.659.904

SEALS FOR AIRMIX® GUN SEATS

Description	Quantity	Part number
Seals for stainless steel or carbide seats	10	129.629.922

IN-LINE PAINT FILTER

With its compact dimensions, it fits on base of the handle or between two hoses.

FILTERS

Description	Set-up	Maximum fluid pressure (bar)	Thread		Part number
			Inlet	Outlet	
Stainless steel filters supplied with 6 screen - 168µ	Between 2 hoses	200 bar	M1/2 JIC	M1/2 JIC	155.010.000
	At the gun fluid inlet		M1/2 JIC	F1/2 JIC	155.010.100

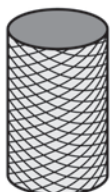

GUN FLUID FILTER SCREEN

PART NUMBERS

Stainless steel screen for filter	Size (µ)	Quantity	Part number
N° 4	100	5	129.609.907
N° 6	168	5	129.609.908
N° 12	280	5	129.609.909

EXTENSION FOR AVX AND AXC SPRAY GUNS

EXTENSIONS

Description	Length (cm)	Part number
Straight extension	25	075.800.011
Straight extension	40	075.800.012
Elbow extension (45° angle)	25	075.850.011

NOTES

A series of horizontal dashed lines for taking notes.

Airmix® spraying

Plural component pumps and machines

Fittings and air treatment

AIRMIX® 10C18 paint pumps



The 10C18 complete Plug & Spray outfit comprises of the pump available in wall-mounted or tripod configuration, the Airmix® Xcite™ 120 bar gun fitted with a 06.094 tip and 7,5m fluid and air hoses in one single package.

The 10C18 kit comprises of the pump available in wall-mounted with or without suction rod, the Airmix® Xcite™ 120 bar gun without tip or hoses in one single packaging.

Recommended for small industries to benefit of both Airmix® spray technology advantages and simple and performing SAMES KREMLIN pump range. Economic solution to handle low viscosity materials (up to 500 cps) with a very low motor air consumption and a low volume fluid section for fast color changes with a minimum of product loss.

FEATURES

FEATURES	BENEFITS
Small fluid section and suction rod	Less product loss during color-changing and pump flushing
The gun/pump kits work with a compressor of 0,5 HP	Reduction of operational costs
Simple design, reduced number of spare parts	Easy maintenance
Compact design	Fits in small working areas

SPECIFICATIONS

Pressure ratio	10/1
Fluid volume per cycle (cm³)	18
Number of cycles per litre of products	55
Fluid Output at 30 cycles/mn (l/mn)	0,55
Air consumption (m3/h) at 30 cycles/mn at 4 bar	1,9
Free flow rate (L/mn)	1,1
Maximum air inlet pressure (bar)	6
Maximum fluid pressure (bar)	60
Maximum Fluid Temperature (°C)	60
Balanced acoustic pressure (dBA)	79,4
Sealing Packings	Upper sealing: Stainless steel cartridge with GT sealing Lower sealing: PFA seals (*red PU as an option)
Weight (kg) (w/o support or rods)	5,30
Wetted parts	Hard chrome stainless steel, treated stainless steel, stainless steel
Height (cm)	39
Width (cm)	27
Depth (cm)	15

FITTINGS

Fitting	Air inlet (valve)	F 3/8" BSP
	Air outlet (atomization air)	M 1/4" NPS
	Fluid Inlet	F 1/2" BSP or M 26x125
	Fluid Outlet	M 1/2" JIC

AIRMIX® 10C18 paint pump



COMPLETE PLUG & SPRAY AIRMIX® 10C18 OUTFIT WITH XCITE™ GUN, AIRCAP AND TIP, FLUID AND AIR HOSES

Kit designation	Gun type	Filter (fitted on fluid tube)	Aircap Type	Nozzle type	Suction rod	Hoses Length (m)	Filter pump outlet	Kit part number
Complete wall-mounted	Xcite™ 120	●	VX24	06.094	-	7,5	-	151.665.730
Complete wall-mounted	Xcite™ 120	●	VX24	06.094	● Ø 6.35 (fluid inlet M 26x125)	7,5	-	151.665.740
Complete tripod	Xcite™ 120	●	VX24	06.094	● Ø 6.35 (fluid inlet M 26x125)	7,5	-	151.665.760
Complete tripod	Xcite™ 120	●	VX24	06.094	● Straight suction tube (fluid inlet M 26x125)	7,5	-	151.665.770
Complete wall-mounted	Xcite™ 120	●	VX24	06.094	● Ø 16 (fluid inlet M 26x125)	7,5	-	151.665.780



AIRMIX® 10C18 PACKAGE WITH XCITE™ GUN WITHOUT TIP NOR HOSES

Kit designation	Gun type	Filter (fitted on fluid tube)	Aircap Type	Nozzle type	Suction rod	Hoses Length (m)	Filter pump outlet	Kit part number
Wall-mounted	Xcite™ 120	●	VX 24	-	Without (fluid inlet F 1/2" BSP)	-	-	151.665.700
Wall-mounted	Xcite™ 120	●	VX 24	-	● Ø 6.35 (fluid inlet M 26x125)	-	-	151.665.720

KITS

Description	Part number
Repair kit for 340/2 air motor	144.850.150
C18 fluid section repair kit	144.855.799
* PU red seal for exhaust valve - recommended for water-based materials	144.855.704

SEAL KITS

Description	Part number
Tripod	151.665.705
Single Post Cart	051.730.110
Handle	051.665.651
Suction rod Ø6.35 plunging tube length 420mm	151.665.640
Easyflush suction rod Ø16 plunging tube length 600 mm	149.596.050
Easyflush suction rod Ø16 plunging tube length 1000mm (for 200 liters drums)	149.596.060

AIRMIX® 10C50 paint pump - stainless steel

Ideal for water-based and high solids materials.

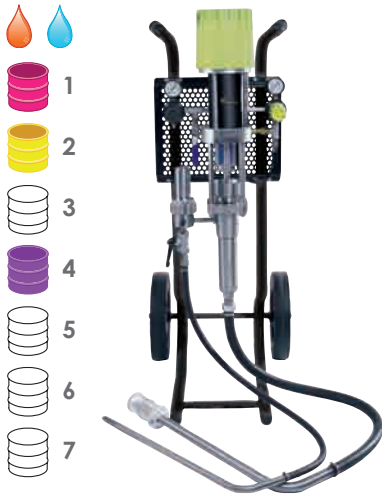

Model shown on a two-arm cart

FEATURES

- Large diameter suction rod and high compression ratio
- Stainless steel design
- Simple design, reduced number of spare parts

BENEFITS

- Can be used with a wide range of materials
- Compatible with water-based materials
- Easy maintenance

SPECIFICATIONS

Pressure ratio	10/1
Fluid volume per cycle (cm ³)	50
Number of cycles per litre of products	20
Fluid Output at 30 cycles/mn (l/mn)	1.5
Free flow rate (L/mn)	3
Air consumption (m ³ /h) at 30 cycles/mn at 4 bar	10.8
Maximum air inlet pressure (bar)	6
Maximum fluid pressure (bar)	60
Maximum Fluid Temperature (°C)	60
Sound level (dBA)	82
Sealing Packings	Upper sealing Lower sealing
	GT seal cartridge GT seal
Weight (kg)	17
Wetted parts	Stainless steel
Height (cm)	82
Width (cm)	35
Depth (cm)	21

FITTINGS

Fitting	Air inlet (valve)	F 3/8" BSP
	Air outlet (atomization air)	M 1/4" NPS
	Fluid Inlet	M 26 x 125
	Fluid output (filter)	M 1/2" JIC

CONFIGURATION OF THE AIRMIX® 10C50 PAINT PUMP

Set-up	Sealing packings		Suction rod (Ø 25)	Drain rod	Atomization air regulator	Air regulator Fluid pressure	Pump output filter	Part number
	Lower sealing	Upper sealing						
Wall mounted	GT seal	GT seal cartridge	●	-	●	●	-	151.777.200
Wall mounted	GT seal	GT seal cartridge	●	●	●	●	●	151.777.100

AIRMIX® 10C50 paint pump - stainless steel

KITS

Description	Part number
GT seal kit	144.950.091
GT repair kit	144.950.096
250-4 air motor seal kit	146.260.991
250-4 air motor maintenance kit	146.260.996

CART, GRAVITY HOPPER AND RODS (SUCTION AND FLUSHING)

Description	Part number
Single Post Cart	051.730.110
Two Post Cart w/o plate	051.221.000
Two Post Pump Mounting Plate	056.100.199
Gravity Hopper 6 liters	151.140.230
Easyflow suction rod Ø25 plunging tube length 600 mm	149.596.150
Easyflow suction rod Ø25 plunging tube length 1000mm (for 200 liters drums)	149.596.160
Stainless steel flushing rod F18 x 125	049.596.000
Fluid filter	155.580.300

AIRMIX® 15C25 & 15C25 MB-A paint pump - stainless steel



True accelerator of performance for your AIRMIX® Xcite™ gun, **the new paint pump Sames Kremlin** range brings together Efficiency, Optimization and Simplicity.

The innovative design and component quality bring reliability and performance and allow for very simple maintenance, easy cleaning and safe color changes while using a minimum of solvents. The cost of ownership is reduced at a minimum.

The new air motor design allows a smooth start-up under low pressure air and perfectly controlled fluid output, without any pulsation at the gun with very low air consumption.

Stainless steel pump fluid section allows to handle the last generation of paints.

Versions equipped with GT cartridge are recommended for **solvent-based paints**. Versions equipped with **latest technology single block MB-A cartridge** allows to increase the chemical resistivity and are recommended for **waterborne and two components paints**.

FEATURES	BENEFITS
Closed design with protective carter between air motor and fluid section	Lubricant protection against external pollution Full operator safety
Stainless steel design	Compatible with water-based materials
Double stroke fluid section	Steady output without any pulsation
Large suction valve	Recommended for materials up to 5000 cps
Compact	Fits in small working areas
New cart and tripod design	Perfect stability (cart or tripod)
New filter and gravity hooper	Filtration optimized for sensible materials (recycled) Circulating for charged materials
New suction rods Easy Flow (Ø 16)	Ø 16: recommended for frequent color changes
Simple design, reduced number of spare parts	Easy maintenance
Simple and accessible air motor/fluid section coupling without tie rod	Possibility to rotate the fluid section to adjust the fluid output on the application
Fluid section with mobile lower packing construction	Improved material refilling and emptying for constant output Improved sealing - easier maintenance
MB-A single block cartridge	High chemical resistance and mechanical friction
Differential air motor	Very simple, a few parts, minimum maintenance

SPECIFICATIONS		
Pressure ratio		15/1
Fluid volume per cycle (cm³)		25 (2 x 12.5)
Number of cycles per litre of products		40
Fluid Output at 30 cycles/mn (l/mn)		0.75
Air consumption (m³/h) at 30 cycles/mn at 4 bar		2.8
Free flow rate (L/mn)		1.5
Maximum air inlet pressure (bar)		6
Maximum fluid pressure (bar)		90
Maximum Fluid Temperature (°C)		60
Sound pressure level (dBa)		71.2
Sealing Packings	Upper sealing	Stainless steel cartridge with GT sealing or patented MB-A single block cartridge
	Lower sealing	UHMW polyethylene seal
Weight (kg) (w/o support or rods)		7.6
Wetted parts		hard chrome stainless steel, treated stainless steel, stainless steel
Height (cm) - bare pump		58.5
Width (cm) - bare pump		15.8
Depth (cm) - bare pump		17

FITTINGS		
Fitting	Air inlet (valve)	F 3/8 BSP
	Air outlet (atomization air)	M 1/4" NPS
	Fluid Inlet	F 1/2" BSP or M 26x125
	Fluid Outlet	M 1/2" JIC

AIRMIX® 15C25 & 15C25 MB-A paint pump - stainless steel

CONFIGURATION OF THE AIRMIX® 15C25 PAINT PUMP - STAINLESS STEEL

Set-up	Fluid inlet fitting	Suction rod	Drain rod	Atomization air regulator	Fluid pressure regulator	Filter pump outlet	Part number
Wall-mounted w/o rods	M 26x125	-	-	●	●	-	151.140.000
Wall-mounted w/o rods	F 1/2 BSP	-	-	●	●	-	151.140.320
Wall-mounted with suction rod	M 26x125	Ø 16	-	●	●	-	151.140.100
Wall-mounted with suction rod	M 26x125	Ø 16	-	●	●	●	151.140.150

CONFIGURATION OF THE AIRMIX® 15C25 MB-A PAINT PUMP - STAINLESS STEEL

Set-up	Fluid inlet fitting	Suction rod	Drain rod	Atomization air regulator	Fluid pressure regulator	Filter pump outlet	Part number
Wall-mounted MB-A w/o rods	M 26x125	-	-	●	●	-	151.140.400
Wall-mounted MB-A w/o rods	F 1/2 BSP	-	-	●	●	-	151.140.450
Wall-mounted MB-A with suction rod	M 26x125	Ø 16	-	●	●	-	151.140.500

KITS

Description	Part number
Repair kit 245-2 air motor	144.140.190
Repair kit	144.130.291

STAND, CART, GRAVITY HOPPER AND RODS (SUCTION AND FLUSHING)

Description	Part number
Wall-mounted totem	151.140.240
Stand	151.140.210
Double Post Cart	151.240.000
Gravity Hopper 6 liters	151.140.230
Easyflush suction rod Ø16 plunging tube length 600 mm	149.596.050
Easyflush suction rod Ø16 plunging tube length 1000mm (for 200 liters drums)	149.596.060
Easyflow suction rod Ø25 plunging tube length 600 mm	149.596.150
Easyflow suction rod Ø25 plunging tube length 1000mm (for 200 liters drums)	149.596.160
Stainless steel flushing rod F18 x 125	049.596.000
Fluid filter	155.580.600



AIRMIX® 15C25 PAINT PUMP KITS WITH SWIVEL FITTING XCITE™ GUN

Kit designation	Gun type	Aircap Type	Tip	Suction rod	Hoses Length (m)	Pump output filter	Part number
Wall-mounted with Xcite™ gun kit	Xcite™ 120	VX 24	To be ordered separately (see table page 18)	-	7.5	-	151.260.976
Wall-mounted with Xcite™ gun kit	Xcite™ 120	VX 24	To be ordered separately (see table page 18)	Ø 16	7.5	-	151.260.974



AIRMIX® 15C25 PAINT PUMP KITS WITHOUT SWIVEL FITTING XCITE™ GUN

Kit designation	Gun type	Aircap Type	Tip	Suction rod	Hoses Length (m)	Pump output filter	Part number
Wall-mounted with Xcite™ gun kit	Xcite™ 120	VX 24	To be ordered separately (see table page 18)	Ø 16	7.5	-	151.261.001

AIRMIX® 15C50 paint pump - stainless steel



True accelerator of performance for your AIRMIX® Xcite™ gun, the 15C50 combines a compact design with robustness and ease of use.

15C50 pumps are designed to meet the needs of manual applications in many industrial markets.

With a priming from 0.6 bar, the pump ensures a controlled and constant flow thereby obtaining a homogeneous application with top quality finish. It is recommended for the latest generation of paints thanks to large fluid passages and full stainless steel construction.

It is designed to reduce maintenance time with a reduced number of parts, easy coupling between the air motor and fluid section and intuitive use.

The components were chosen carefully to avoid engine icing and work at high efficiency without stalling.

The 15C50 pumps are available in wall-mounted version with air equipment. A large number of accessories (cart, tripod, product filter, suction rods) allows ideal configuration for each customer.

FEATURES	BENEFITS
Closed design with protective carter between air motor and fluid section	Lubricant protection against external pollution
Stainless steel design	Full operator safety
Double stroke fluid section	Compatible with water-based materials
Large suction valve	Steady output without any pulsation
Compact	Recommended for materials up to 5000 cps
New cart and tripod design	Fits in small working areas
New filter and gravity hooper	Perfect stability (cart or tripod)
	Filtration optimized for sensible materials (recycled)
	Circulating for charged materials
New suction rods Easy Flow (Ø 25)	Recommended for frequent color changes
Simple design, reduced number of spare parts	Easy maintenance
Simple and accessible air motor/fluid section coupling without tie rod	Possibility to rotate the fluid section to adjust the fluid output on the application
Fluid section with mobile lower packing construction	Improved material refilling and emptying for constant output
	Improved sealing - easier maintenance
MB-A single block cartridge	High chemical resistance and mechanical friction
Differential air motor	Very simple, a few parts, minimum maintenance

SPECIFICATIONS

Pressure ratio	15/1
Fluid volume per cycle (cm³)	50 (2 x 25)
Number of cycles per litre of products	20
Fluid Output at 30 cycles/mn (l/mn)	1.5
Air consumption (m³/h) at 30 cycles/mn at 4 bar	2.8
Free flow rate (L/mn)	1.5
Maximum air inlet pressure (bar)	6
Maximum fluid pressure (bar)	90
Maximum Fluid Temperature (°C)	60
Maximum product viscosity (cps)	5000
Sound pressure level (dBa)	76.6
Sealing Packings	Upper sealing Stainless steel cartridge with GT sealing
	Lower sealing UHMW polyethylene seal
Weight (kg) (w/o support or rods)	8
Wetted parts	hard chrome stainless steel, stainless steel
Height (cm) - bare pump	58.5
Width (cm) - bare pump	15.9
Depth (cm) - bare pump	16

FITTINGS

Fitting	Air inlet (valve)	F 3/8 BSP
	Air outlet (atomization air)	M 1/4" NPS
	Fluid Inlet	F 1/2" BSP or M 26x125
	Fluid Outlet	M 1/2" JIC

AIRMIX® 15C50 paint pump - stainless steel

CONFIGURATION OF THE AIRMIX® 15C50 PAINT PUMP - STAINLESS STEEL

Set-up	Fluid inlet fitting	Suction rod	Drain rod	Atomization air regulator	Fluid pressure regulator	Filter pump outlet	Part number
Wall-mounted	F 1/2 BSP	-	-	-	●	-	151.143.500
Wall-mounted with filter	M 26x125	-	●	●	●	●	151.143.450
Wall-mounted with rod and filter	M 26x125	Ø 25	●	●	●	●	151.143.250

KITS

Description	Part number
Repair kit 420-4 air motor	144.140.190

ACCESSORIES

Description	Part number
Wall-mounted totem	151.140.240
Stand	151.140.210
Double Post Cart	151.240.000
Gravity Hopper 6 liters	151.140.230
Easyflow suction rod Ø25 plunging tube length 600 mm	149.596.150
Easyflow suction rod Ø25 plunging tube length 1000mm (for 200 liters drums)	149.596.160
Stainless steel flushing rod F18 x 125	049.596.000
Fluid filter	155.580.600

AIRMIX® 16C240 paint pump - stainless steel

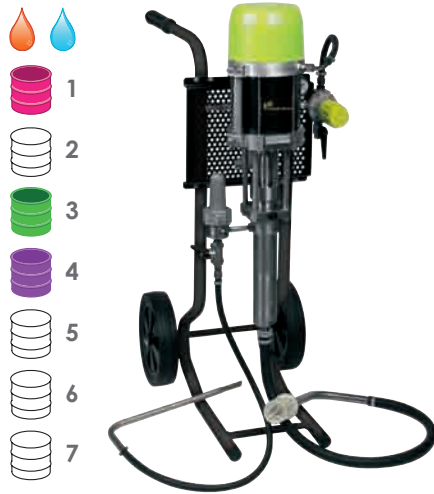

For circulating and large production.
The Turbo air motor is recommended for continued use.

FEATURES

Large diameter suction rod and high compression ratio
Stainless steel design
Simple design , reduced number of spare parts

BENEFITS

Can be used with a wide range of materials
Compatible with water-based materials
Easy maintenance

SPECIFICATIONS

Pressure ratio	16/1
Fluid volume per cycle (cm ³)	240
Number of cycles per litre of products	4
Fluid Output at 30 cycles/mn (l/mn)	7.20
Free flow rate (L/mn)	14.4
Air consumption @ 30 CPM at 5 bar	41.5
Maximum air inlet pressure (bar)	6
Maximum fluid pressure (bar)	96
Maximum Fluid Temperature (°C)	60
Sound level (dBA)	76
Sealing Packings	Upper sealing Lower sealing
	PTFE G + Polyfluid PEHD
Weight (kg) - wall-mounted	27
Wetted parts	Stainless steel
Height (cm)	86.4
Width (cm)	35.6
Depth (cm)	25.4

FITTINGS

Fitting	Air inlet (valve air equipment)	F 3/4 BSP
	Fluid Inlet	M 26 x 125
	Fluid output (filter)	M 1/2 JIC

CONFIGURATION OF THE AIRMIX® 16C240 PAINT PUMP

Set-up	Suction rod (Ø 25)	Drain rod	Atomization air regulator	Air regulator Fluid pressure	Pump output filter	Part number
Bare	-	-	-	-	-	151.790.000
Wall mounted	-	-	●	●	-	151.790.100
Wall mounted	●	●	●	●	●	151.790.200
2 arm cart mounted	●	●	●	●	●	151.790.400
Turbo wall-mounted	-	-	●	●	-	151.797.100

KITS

Description	Part number
Seal kit H120	144.970.090
Repair kit H120	144.970.095
Seal kit for 2000-4 air motor	146.270.990
Repair kit for 2000-4 air motor	146.270.996

CARTS AND RODS (SUCTION AND DRAIN)

Description	Part number
Two Post Cart w/o plate	051.221.000
Two Post Pump Mounting Plate	056.100.199
Easyflow suction rod Ø25 plunging tube length 600 mm	149.596.150
Easyflow suction rod Ø25 plunging tube length 1000mm (for 200 liters drums)	149.596.160
Stainless steel flushing rod F18 x 125	049.596.000
Fluid filter	155.580.300

AIRMIX® 20C50 paint pump - stainless steel

Ideal for water-based and high solids materials.

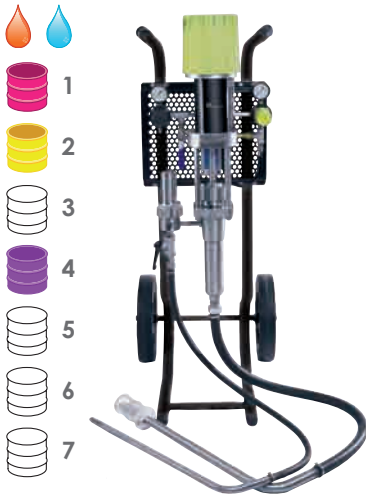

FEATURES

Large diameter suction rod and high compression ratio
 Stainless steel design
 Simple design , reduced number of spare parts

BENEFITS

Can be used with a wide range of materials
 Compatible with water-based materials
 Easy maintenance

SPECIFICATIONS

Pressure ratio	20/1
Fluid volume per cycle (cm ³)	50
Number of cycles per litre of products	20
Fluid Output at 30 cycles/mn (l/mn)	1.5
Free flow rate (L/mn)	3
Air consumption (m ³ /h) at 30 cycles/mn at 4 bar	10.8
Maximum air inlet pressure (bar)	6
Maximum fluid pressure (bar)	120
Maximum Fluid Temperature (°C)	60
Sound level (dBA)	78
Sealing Packings	Upper sealing Lower sealing
	Polyfluid + PTFE G or GT seal GT sealing
Weight (kg)	17
Wetted parts	Stainless steel
Height (cm)	83.8
Width (cm)	35.6
Depth (cm)	17.78

FITTINGS

Fitting	Air inlet (valve)	F 3/8" BSP
	Air outlet (atomization air)	M 1/4" NPS
	Fluid Inlet	M 26 x 125
	Fluid output (filter)	M 1/2" JIC

CONFIGURATION OF THE AIRMIX® 20C50 PAINT PUMP

Set-up	Sealing packings		Suction rod (Ø 25)	Drain rod	Atomization air regulator	Air regulator Fluid pressure	Pump output filter	Part number
	Lower sealing	Upper sealing						
Wall mounted	GT seal	Polyfluid + PTFE G	●	-	●	●	-	151.770.200
Wall mounted	GT seal	Polyfluid + PTFE G	●	●	●	●	●	151.770.100
Wall mounted (GT seal)	GT seal	GT seal	●	●	●	●	●	151.773.100
1 arm cart mounted	GT seal	Polyfluid + PTFE G	●	●	●	●	●	151.770.150

KITS

Description	Part number
GT seal kit	144.950.091
GT repair kit	144.950.096
Seal kit for 500-4 air motor	146.260.990
Repair kit for 500-4 air motor	146.260.995

CART, GRAVITY HOPPER AND RODS (SUCTION AND FLUSHING)

Description	Part number
Single Post Cart	051.730.110
Two Post Cart w/o plate	051.221.000
Two Post Pump Mounting Plate	056.100.199
Gravity Hopper 6 liters	151.140.230
Easyflow suction rod Ø25 plunging tube length 600 mm	149.596.150
Easyflow suction rod Ø25 plunging tube length 1000mm (for 200 liters drums)	149.596.160
Stainless steel flushing rod F18 x 125	049.596.000
Fluid filter	155.580.300



AIRMIX® 20C50 PAINT PUMP KITS- STAINLESS STEEL WITH SWIVEL FITTING XCITE™ GUN

Kit designation	Gun type	Supplied with aircap	Tip	Suction rod	Drain rod	Hoses Length (m)	Pump output filter	Part number
Wall-mounted Kit	Xcite™ 120	VX24	To be ordered separately (see table page 18)	●	●	7.5	●	151.260.966
Wall-mounted GT kit	Xcite™ 120	VX24	To be ordered separately (see table page 18)	●	●	7.5	●	151.260.973

AIRMIX® 20C100 paint pump - stainless steel



The AIRMIX® 20C100 paint pump is ideal for water-based and high solids.
The Turbo air motor is recommended for continued use.

FEATURES

- Simple design , reduced number of spare parts
- Large diameter suction rod and high compression ratio
- Stainless steel design

BENEFITS

- Easy maintenance
- Can be used with a wide range of materials
- Compatible with water-based products

SPECIFICATIONS

Pressure ratio	20/1
Fluid volume per cycle (cm ³)	100
Number of cycles per litre of products	10
Fluid Output at 30 cycles/mn (l/mn)	3
Free flow rate (L/mn)	6
Air consumption (m ³ /h) at 30 cycles/mn at 4 bar	21.6
Maximum air inlet pressure (bar)	6
Maximum fluid pressure (bar)	120
Maximum Fluid Temperature (°C)	60
Sound level (dBA)	78
Sealing Packings	Upper sealing Lower sealing
	Polyfluid + PTFE G GT
Weight (kg)	22
Wetted parts	Stainless steel
Height (cm)	86.4
Width (cm)	35.6
Depth (cm)	28

FITTINGS

Fitting	Air inlet (valve)	F 3/8" BSP
	Air outlet (atomization air)	M 1/4" NPS
	Fluid Inlet	M 26 x 125
	Fluid output (filter)	M 1/2" JIC

CONFIGURATION OF THE AIRMIX® 20C100 PAINT PUMPS

Set-up	Suction rod (Ø 25)	Drain rod	Atomization air regulator	Air regulator Fluid pressure	Pump output filter	Part number
Wall mounted	●	-	●	●	-	151.780.100
Wall mounted	●	●	●	●	●	151.780.200
Turbo wall mounted	-	-	●	●	-	151.782.100

AIRMIX® 20C100 paint pump - stainless steel

KITS

Description	Part number
GT seal kit	144.960.091
GT repair kit	144.960.096
Seal kit for 1000-4 air motor	146.270.991
Repair kit for 1000-4 air motor	146.270.995

CART AND RODS (SUCTION AND FLUSHING)

Description	Part number
Single Post Cart	051.730.110
Two Post Cart w/o plate	051.221.000
Two Post Pump Mounting Plate	056.100.199
Easyflow suction rod Ø25 plunging tube length 600 mm	149.596.150
Easyflow suction rod Ø25 plunging tube length 1000mm (for 200 liters drums)	149.596.160
Stainless steel flushing rod F18 x 125	049.596.000
Fluid filter	155.580.300

AIRMIX® 30C25 & 30C25 MB-A paint pump - stainless steel



True accelerator of performance for your AIRMIX® Xcite™ gun, **the new paint pump Sames Kremlin** range brings together Efficiency, Optimization and Simplicity.

The innovative design and component quality bring reliability and performance and allow for very simple maintenance, easy cleaning and safe color changes while using a minimum of solvents. The cost of ownership is reduced at a minimum.

The new air motor design allows a smooth start-up under low pressure air and perfectly controlled fluid output, without any pulsation at the gun with very low air consumption.

Stainless steel pump fluid section allows to handle the last generation paints.

Versions equipped with GT cartridge are recommended for **solvent-based paints**.

Versions equipped with **latest technology single block MB-A cartridge** allows to increase the chemical resistivity and are recommended for **waterborne and two components paints**.

FEATURES

BENEFITS

Closed design with protective carter between air motor and fluid section	Lubricant protection against external pollution Full operator safety
Stainless steel design	Compatible with water-based materials
Double stroke fluid section	Steady output without any pulsation
Large suction valve	Recommended for materials up to 5000 cps
Compact	Fits in small working areas
New cart and tripod design	Perfect stability (cart or tripod)
New filter and gravity hooper	Filtration optimized for sensible materials (recycled) Circulating for charged materials
New suction rods	Ø 16: recommended for frequent color changes
Easy Flow (Ø 16)	Ø 25: recommended for high viscosity materials up to 5000 cps
Easy Flow (Ø 25)	
Simple design, reduced number of spare parts	Easy maintenance
Simple and accessible air motor/fluid section coupling without tie rod	Possibility to rotate the fluid section to adjust the fluid output on the application
Fluid section with mobile lower packing construction	Improved material refilling and emptying for constant output Improved sealing - easier maintenance
MB-A single block cartridge	High chemical resistance and mechanical friction
Differential air motor	Very simple, a few parts, minimum maintenance

SPECIFICATIONS

Pressure ratio	30/1
Fluid volume per cycle (cm ³)	25 (2 x 12.5)
Number of cycles per litre of products	40
Fluid Output at 30 cycles/mn (l/mn)	0.75
Air consumption (m ³ /h) at 30 cycles/mn at 4 bar	7.1
Free flow rate (L/mn)	1.5
Maximum air inlet pressure (bar)	6
Maximum fluid pressure (bar)	180
Maximum Fluid Temperature (°C)	60
Sound pressure level (dBa)	74.9
Sealing Packings	Upper sealing Stainless steel cartridge with GT sealing or patented MB-A single block cartridge
	Lower sealing UHMW polyethylene seal
Weight (kg) (w/o support or rods)	7.6
Wetted parts	Hard chrome stainless steel, treated stainless steel, stainless steel
Height (cm) - bare pump	58.5
Width (cm) - bare pump	15.8
Depth (cm) - bare pump	17

FITTINGS

Fitting	Air inlet (valve)	F 3/8 BSP
	Air outlet (atomization air)	M 1/4" NPS
	Fluid Inlet	F 1/2" BSP or M 26x125
	Fluid Outlet	M 1/2 JIC

AIRMIX® 30C25 & 30C25 MB-A paint pump - stainless steel

CONFIGURATION OF THE AIRMIX® 30C25 PAINT PUMP - STAINLESS STEEL

Set-up	Fluid inlet fitting	Suction rod	Drain rod	Atomization air regulator	Fluid pressure regulator	Filter pump outlet	Part number
Wall-mounted pump	M 26x125	-	-	●	●	-	151.145.000
Wall-mounted pump	F 1/2 BSP	-	-	●	●	-	151.145.320
Wall-mounted pump with rod	M 26x125	Ø 16	-	●	●	-	151.145.100
Wall-mounted pump with rod	M 26x125	Ø 16	-	●	●	●	151.145.200
Wall-mounted pump with rod	M 26x125	Ø 25	-	●	●	-	151.145.150
Wall-mounted pump with rod and filter	M 26x125	Ø 25	-	●	●	●	151.145.250

CONFIGURATION OF THE AIRMIX® 30C25 MB-A PAINT PUMP - STAINLESS STEEL

Set-up	Fluid inlet fitting	Suction rod	Drain rod	Atomization air regulator	Fluid pressure regulator	Filter pump outlet	Part number
Wall-mounted pump	M 26x125	-	-	●	●	-	151.145.400
Wall-mounted pump	F 1/2 BSP	-	-	●	●	-	151.145.450
Wall-mounted pump with rod and filter	M 26x125	Ø 25	-	●	●	●	151.145.600

REPAIR KITS

Description	Part number
Repair kit 420-4 air motor	144.130.190
Repair kit H C25	144.130.291

STAND, CART, GRAVITY HOPPER AND RODS (SUCTION AND FLUSHING)

Description	Part number
Wall-mounted totem	151.140.240
Stand	151.140.210
Double Post Cart	151.240.000
Gravity Hopper 6 liters	151.140.230
Easyflow suction rod Ø16 plunging tube length 600 mm	149.596.050
Easyflow suction rod Ø16 plunging tube length 1000mm (for 200 liters drums)	149.596.060
Easyflow suction rod Ø25 plunging tube length 600 mm	149.596.150
Easyflow suction rod Ø25 plunging tube length 1000mm (for 200 liters drums)	149.596.160
Stainless steel flushing rod F18 x 125	049.596.000
Fluid filter	155.580.600



AIRMIX® 30C25 PAINT PUMP KITS WITH SWIVEL FITTING XCITE™ GUN

Kit designation	Gun type	Aircap Type	Tip	Suction rod	Hoses Length (m)	Pump output filter	Part number
Wall-mounted with Xcite™ gun kit pump	Xcite™ 200	VX24	To be ordered separately (see table page 18)	-	7.5	-	151.260.977
Wall-mounted with Xcite™ gun kit pump with rod	Xcite™ 200	VX 24	To be ordered separately (see table page 18)	Ø 16 mm	7.5	-	151.260.975
Wall-mounted with Xcite™ gun kit pump with rod and filter	Xcite™ 200	VX 24	To be ordered separately (see table page 18)	Ø 25 mm	7.5	●	151.260.978



AIRMIX® 30C25 PAINT PUMP KITS WITHOUT SWIVEL FITTING XCITE™ GUN

Kit designation	Gun type	Aircap Type	Tip	Suction rod	Hoses Length (m)	Pump output filter	Part number
Wall-mounted with Xcite™ gun kit pump with rod and filter	Xcite™ 200	VX 24	To be ordered separately (see table page 18)	Ø 25 mm	7.5	-	151.261.002

AIRMIX® 16F240 FLOWMAX® paint pump - stainless steel



For circulating and large production.
The Turbo air motor is recommended for continued use.

FEATURES

- Sealing done by one large stroke bellow
- Ergonomic design of fluid passages
- Stainless steel design
- Balanced fluid section
- Mobile piston seal

BENEFITS

- High reliability
- No more lubricant cups
- Leak free
- Total sealing between pump and its environment, ideal to work with moisture-sensitive catalysts
- Ideal for UV and pre-catalyzed materials
- Fluid discharge without retention of a wide range of coating materials
- Compatible with water-based materials
- Constant fluid output pressure
- Excellent suction capacity

SPECIFICATIONS

Pressure ratio	16/1
Fluid volume per cycle (cm ³)	240
Number of cycles per litre of products	4
Fluid Output at 30 cycles/mn (l/mn)	7.2
Free flow rate (L/mn)	14.4
Air Consumption @ 20 CPM at 5 bar	41.5
Maximum air inlet pressure (bar)	6
Maximum fluid pressure (bar)	96
Maximum Fluid Temperature (°C)	50
Sound level (dBA)	76
Sealing packing	Bellows Upper and lower
	Polyethylene GT polyethylene
Weight (kg)	32
Wetted parts	Stainless steel
Height (cm)	105
Width (cm)	40
Depth (cm)	27

FITTINGS

Fitting	Air inlet (air equipment)	F 3/4 BSP
	Fluid Inlet	M 26 x 125
	Fluid output (filter)	M 1/2 JIC

AIRMIX® 16F240 FLOWMAX® paint pump - stainless steel

CONFIGURATION OF THE AIRMIX® 16F240 FLOWMAX® PAINT PUMP - STAINLESS STEEL

Set-up	Suction rod (Ø 25)	Drain rod	Atomization air regulator	Air regulator Fluid pressure	Pump output filter	Part number
Bare pump	-	-	-	-	-	151.793.000
Wall mounted	-	-	●	●	-	151.793.100
Wall mounted	●	●	●	●	●	151.793.200
2 arm cart-mounted	●	●	●	●	●	151.793.400
Turbo wall-mounted	-	-	●	●	-	151.796.100
Turbo wall-mounted	●	●	●	●	●	151.796.200

KITS

Description	Part number
Seal kit	144.970.490
Repair kit	144.970.495
Seal kit for 2000-4 air motor	146.270.990
Repair kit for 2000-4 air motor	146.270.996

CARTS AND RODS (SUCTION AND FLUSHING)

Description	Part number
Two Post Cart w/o plate	051.221.000
Two Post Pump Mounting Plate	056.100.199
Easyflow suction rod Ø25 plunging tube length 600 mm	149.596.150
Easyflow suction rod Ø25 plunging tube length 1000mm (for 200 liters drums)	149.596.160
Stainless steel flushing rod F18 x 125	049.596.000
Fluid filter	155.580.300

AIRMIX® 17F60 FLOWMAX® paint pump - stainless steel



Unique design with external valves for an easy maintenance. Flowmax® technology ensures total sealing. Quick inversion of this pump allows for a perfectly stable fan shape at the gun.
Performance, extended lifetime, reliability.

FEATURES

- External valves assembly
- Floating piston
- Sealing ensured by a Superlife™ bellow seal

BENEFITS

- Easy maintenance
- Fast inversions and very high efficiency
- High reliability
- No more lubricant cups
- Leak free
- Total sealing between pump and its environment, ideal to work with moisture-sensitive catalysts
- Ideal for UV and pre-catalyzed materials
- Compatible with water-based materials
- Fluid discharge without retention of a wide range of coating materials
- Constant fluid output pressure

SPECIFICATIONS

Pressure ratio	17/1	
Fluid volume per cycle (cm ³)	60	
Number of cycles per litre of products	16	
Fluid Output at 30 cycles/mn (l/mn)	1.8	
Free flow rate (L/mn)	3.6	
Air consumption (m ³ /h) at 30 cycles/mn at 4 bar	11	
Maximum air inlet pressure (bar)	6	
Maximum fluid pressure (bar)	100	
Maximum Fluid Temperature (°C)	50	
Sound level (dBA)	74	
Sealing packing	Bellows	Polyethylene
	Upper and lower	GT polyethylene
Weight (kg) - wall-mounted	20	
Wetted parts	Stainless steel	
Height (cm)	62.2	
Width (cm)	33	
Depth (cm)	21	

FITTINGS

Fitting	Air inlet (valve)	F 3/8" BSP
	Air outlet (atomization air)	M 1/4" NPS
	Fluid Inlet	M 26 x 125
	Fluid output (filter)	M 1/2 JIC

CONFIGURATION OF THE AIRMIX® 17F60 PAINT PUMPS - STAINLESS STEEL

Set-up	Suction rod (Ø 25)	Drain rod	Atomization air regulator	Air regulator Fluid pressure	Pump output filter	Part number
Wall-mounted	●	●	●	●	●	151.730.700
1 arm cart	●	●	●	●	●	151.730.750

KITS

Description	Part number
Seal kit for A2 fluid section	144.910.799
Repair kit for A2 fluid section	144.910.797
Seal kit for external valves	144.910.798
Seal kit for 1000-2 air motor	144.919.904
Repair kit for 1000-2 air motor	144.919.914

AIRMIX® 17F60 FLOWMAX® paint pump - stainless steel

CARTS AND RODS (SUCTION AND FLUSHING)

Description	Part number
Single Post Cart	051.730.110
Two Post Cart w/o plate	051.221.000
Two Post Pump Mounting Plate	056.100.199
Easyflow suction rod Ø25 plunging tube length 600 mm	149.596.150
Easyflow suction rod Ø25 plunging tube length 1000mm (for 200 liters drums)	149.596.160
Stainless steel flushing rod F18 x 125	049.596.000
Fluid filter	155.580.300



AIRMIX® 17F60 PAINT PUMP KIT WITH SWIVEL FITTING XCITE™ GUN

Kit designation	Gun type	Supplied with aircap	Tip	Suction rod (Ø 25)	Drain rod	Hoses Length (m)	Pump output filter	Part number
Wall-mounted stainless steel Kit	Xcite™ 120	VX24	To be ordered separately (see table page 18)	●	●	7.5	●	151.260.967

AIRMIX® 20F50 FLOWMAX® pump - stainless steel

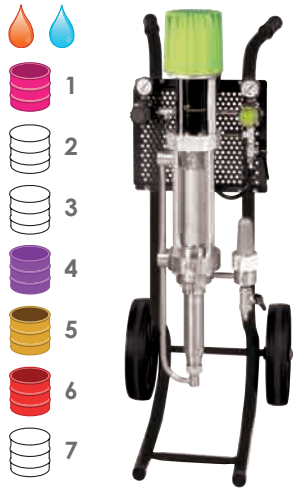

Universal AIRMIX® pump for use with all materials, including water-based and high solids.

FEATURES

- Sealing done by one large stroke bellow
- Ergonomic design of fluid passages
- Stainless steel design
- Balanced fluid section
- Mobile piston seal

BENEFITS

- High reliability
- No more lubricant cups
- Leak free
- Total sealing between pump and its environment, ideal to work with moisture-sensitive catalysts
- Ideal for UV and pre-catalyzed materials
- Fluid discharge without retention of a wide range of coating materials
- Compatible with water-based materials
- Constant fluid output pressure
- Excellent suction capacity

SPECIFICATIONS

Pressure ratio	20/1
Fluid volume per cycle (cm ³)	50
Number of cycles per litre of products	20
Fluid Output at 30 cycles/mn (l/mn)	1.5
Free flow rate (L/mn)	3
Air consumption (m ³ /h) at 30 cycles/mn at 4 bar	10.8
Maximum air inlet pressure (bar)	6
Maximum fluid pressure (bar)	120
Maximum Fluid Temperature (°C)	50
Sound level (dBA)	80
Sealing packing	Bellows Upper and lower
	Polyethylene GT Polyethylene
Weight (kg) - wall-mounted	22
Wetted parts	Stainless steel
Height (cm)	99.1
Width (cm)	48.3
Depth (cm)	28

FITTINGS

Fitting	Air inlet (valve)	F 3/8" BSP
	Air outlet (atomization air)	M 1/4" NPS
	Fluid Inlet	M 26 x 125
	Fluid output (filter)	M 1/2" JIC

CONFIGURATION OF THE AIRMIX® 20F50 FLOWMAX® PAINT PUMP - STAINLESS STEEL

Set-up	Suction rod (Ø 25)	Drain rod	Atomization air regulator	Air regulator Fluid pressure	Pump output filter	Part number
Wall mounted	●	-	●	●	-	151.771.100
Wall mounted	●	●	●	●	●	151.771.200
2 arms cart-mounted	●	●	●	●	●	151.771.400

KITS

Description	Part number
Seal kit	144.950.291
Repair kit	144.950.292
Seal kit for 500-4 air motor	146.260.990
Repair kit for 500-4 air motor	146.260.995

CARTS AND RODS (SUCTION AND FLUSHING)

Description	Part number
Two Post Cart w/o plate	051.221.000
Two Post Pump Mounting Plate	056.100.199
Easyflow suction rod Ø25 plunging tube length 600 mm	149.596.150
Easyflow suction rod Ø25 plunging tube length 1000mm (for 200 liters drums)	149.596.160
Stainless steel flushing rod F18 x 125	049.596.000
Fluid filter	155.580.300

AIRMIX® 20F100 FLOWMAX® pump - stainless steel

Universal AIRMIX® pump for use with all materials, including water-based and high solids.

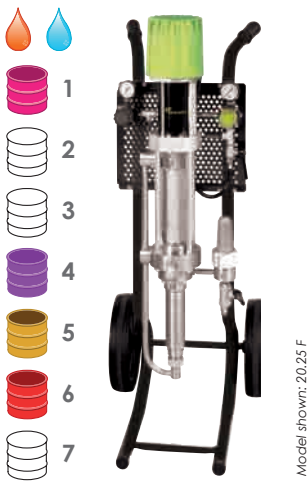

FEATURES

- Sealing done by one large stroke bellow
- Ergonomic design of fluid passages
- Stainless steel design
- Balanced fluid section
- Mobile piston seal

BENEFITS

- High reliability
- No more lubricant cups
- Leak free
- Total sealing between pump and its environment, ideal to work with moisture-sensitive catalysts
- Ideal for UV and pre-catalyzed materials
- Fluid discharge without retention of a wide range of coating materials
- Compatible with water-based materials
- Constant fluid output pressure
- Excellent suction capacity

SPECIFICATIONS

Pressure ratio	20/1
Fluid volume per cycle (cm ³)	100
Number of cycles per litre of products	10
Fluid Output at 30 cycles/mn (l/mn)	3
Free flow rate (L/mn)	6
Air consumption (m ³ /h) at 30 cycles/mn at 4 bar	21.6
Maximum air inlet pressure (bar)	6
Maximum fluid pressure (bar)	120
Maximum Fluid Temperature (°C)	50
Sound level (dBA)	76
Sealing packing	Bellows Upper and lower
	Polyethylene GT Polyethylene
Weight (kg) - wall-mounted	27
Wetted parts	Stainless steel
Height (cm)	97.5
Width (cm)	47
Depth (cm)	27

FITTINGS

Fitting	Air inlet (valve)	F 3/8" BSP
	Air outlet (atomization air)	M 1/4" NPS
	Fluid Inlet	M 26 x 125
	Fluid output (filter)	M 1/2" JIC

CONFIGURATION OF THE AIRMIX® 20F100 FLOWMAX® PAINT PUMP - STAINLESS STEEL

Set-up	Suction rod (Ø 25)	Drain rod	Atomization air regulator	Air regulator Fluid pressure	Pump output filter	Part number
Wall mounted	●	-	●	●	-	151.781.100
Wall mounted	●	●	●	●	●	151.781.200
Turbo Wall mounted	-	-	●	●	-	151.783.100
Turbo Wall mounted	●	●	●	●	●	151.783.200

KITS

Description	Part number
Seal kit	144.960.291
Repair kit	144.960.292
Seal kit for 1000-4 air motor	146.270.991
Repair kit for 1000-4 air motor	146.270.995

CARTS AND RODS (SUCTION AND FLUSHING)

Description	Part number
Two Post Cart w/o plate	051.221.000
Two Post Pump Mounting Plate	056.100.199
Easyflow suction rod Ø25 plunging tube length 600 mm	149.596.150
Easyflow suction rod Ø25 plunging tube length 1000mm (for 200 liters drums)	149.596.160
Stainless steel flushing rod F18 x 125	049.596.000
Fluid filter	155.580.300

PCS 20F440 FLOWMAX® AIRMIX® paint pump - stainless steel



High output, cartridge free bellow pump for circulating and automatic machines.

FEATURES

Sealing done by one large stroke bellow

Ergonomic design of fluid passages

Stainless steel design

Balanced fluid section

Mobile piston seal

BENEFITS

High reliability
No more lubricant cups
Leak free
Total sealing between pump and its environment, ideal to work with moisture-sensitive catalysts
Ideal for UV and pre-catalyzed materials

Fluid discharge without retention of a wide range of coating materials

Compatible with water-based materials

Constant fluid output pressure

Excellent suction capacity

SPECIFICATIONS

Pressure ratio	20/1	
Fluid volume per cycle (cm ³)	440	
Number of cycles per litre of products	2.3	
Fluid Output at 30 cycles/mn (l/mn)	8.8	
Free flow rate (L/mn)	26.4	
Air Consumption @ 20 CPM at 5 bar	63.4	
Maximum air inlet pressure (bar)	6	
Maximum fluid pressure (bar)	120	
Maximum Fluid Temperature (°C)	50	
Sound level (dBA)	< 82	
Sealing packing	Bellows	Polyethylene
	Upper and lower	GT polyethylene
Weight (kg)	66	
Wetted parts	Stainless steel, carbide, hard chromed stainless steel	
Height (cm)	111.5	
Width (cm)	64	
Depth (cm)	32.5	

FITTINGS

Fitting	Air inlet (valve)	F 3/4" BSP
	Fluid Inlet	F 1" BSP
	Fluid Outlet	F 3/4 NPS

CONFIGURATION OF THE PCS 20F440 FLOWMAX® PAINT PUMP - STAINLESS STEEL

Set-up	Suction rod	Drain rod	Air regulator Fluid pressure	Filter	Part number
Wall-mounted	-	-	●	-	151.860.200

CART, FILTER AND RODS (SUCTION AND FLUSHING)

Description	Part number
Two Reinforced Arms w/o mounting plate	051.231.000
Pump bracket	051.341.206
Stainless steel Accumulator equipped filter 3/4"	155.581.400
Suction rod Ø25 plunging tube length 600 mm	049.597.100
Stainless steel flushing rod F18 x 125	049.596.000
Fluid filter	155.580.300

HP 60/61 HEATERS



Their original design ensures an optimized heat transfer, with no risk of burning the paint in the heater. This equipment will allow you to reduce the viscosity of paints without using solvents. It guarantees an outstanding finish quality, whatever the ambient temperature may be.

This version of the equipment is to be used only for water-based materials.

FEATURES

A thermometer is integrated into the command box
Modular design

BENEFITS

No pressure loss when working with high viscosity materials
Easy maintenance

SPECIFICATIONS

Thermostatic type	Liquid dilatation and dry contact
Thermal fuse	Cut-out at 121°C
Thermometer	Graduation 0 - 100°C
Temperature range (°C)	15 - 90
Pressure (bar)	250
Weight (kg)	23
Wetted parts	Body and fittings in stainless steel
Room temperature (°C)	40 maxi

HP HEATER - STAINLESS STEEL VERSION

Stainless steel heater	Voltage / Power		Temperature (°C)	Cable length w/o plug (m)	Fitting		Part number
	Volt	Watt			Inlet	Outlet	
HP60	230	1500	15 - 90	10	M 1/2 JIC	M 1/2 JIC	056.140.700
HP61	115	1500	15 - 90	5	M 1/2 JIC	M 1/2 JIC	056.140.750
HP60	400	1250	15 - 90	5	M 1/2 JIC	M 1/2 JIC	056.140.770

AD 60/61 HEATERS non explosive



Original design ensuring optimum heat transfer with no risk of burning the paint in the heater.

Allows to reduce paint viscosity without dilution.

To be used in zone 1 and 2 according to ATEX.

Agreement INERIS 03ATEX 0079X

 II 2 G EEx d IIA T3

FEATURES

A thermometer is integrated into the command box
Modular design



BENEFITS

No pressure loss when working with high viscosity materials
Easy maintenance



SPECIFICATIONS

Thermostat type	By fluid extension and dry contact
Thermal fuse	Cut at 121°C
Thermometer	Graduation 0 - 100°C
Temperature range (°C)	15 - 80
Pressure (bar)	240 maxi
Weight (kg)	Aluminum: 15.5 Stainless steel: 25
Wetted parts	Aluminum: aluminum body, galvanized chrome fittings Stainless steel: stainless steel body and fittings
Room temperature (°C)	40 maxi

AD HEATERS - ALUMINUM VERSION (SOLVENT-BASED MATERIALS)

Aluminum heater	Voltage / Power		Temperature (°C)	Cable length w/o plug (m)	Fitting		Part number
	Volt	Watt			Inlet	Outlet	
AD60 	230	1500	15 - 80	10	M 1/2 JIC	M 1/2 JIC	056.126.000
AD61 	115	1500	15 - 80	5	M 1/2 JIC	M 1/2 JIC	056.126.050

AD HEATERS - STAINLESS STEEL VERSIONS (SOLVENT OR WATER-BASED MATERIALS)

Stainless steel heater	Voltage / Power		Temperature (°C)	Cable length w/o plug (m)	Fitting		Part number
	Volt	Watt			Inlet	Outlet	
AD60 	230	1500	15 - 80	10	M 1/2 JIC	M 1/2 JIC	056.146.000
AD61 	115	1500	15 - 80	5	M 1/2 JIC	M 1/2 JIC	056.146.050
AD60 	400	1250	15 - 80	5	M 1/2 JIC	M 1/2 JIC	056.146.070

One-Pass™ HEATER non explosive



The economical and reliable solution for a constant spraying quality to reduce the viscosity of paints without adding solvents.

The heating of the product is done in one single passage in the One-pass™ heater thanks to the new design and the optimized thermal exchange efficiency.

This innovative design offers the possibility to install directly the One-pass heater directly between the pump and the gun without recirculation. Its dimensions and reduced weight allow to fit it on a mobile pump (2 arms cart and mounting plate).

To be used in zone 1 and 2 according to ATEX.

Agreement ISSeP 05ATEX031

 II 2 G Ex d IIA T3

FEATURES

- Standard stainless steel version
- A thermometer is integrated into the command box
- Reduced dimensions
- Modular design
- t max: 20°C at an output of 800 cc/mn



BENEFITS

- Compatible with water-based materials
- No pressure loss when working with high viscosity materials
- Mounting on mobile versions
- Quick and easy maintenance
- Optimised performances in most applications

SPECIFICATIONS

Thermostat type	By fluid expansion and dry contact
Thermal fuse	Cut at 72°C
Thermometer	Graduation 0 - 60°C
Temperature range (°C)	15 - 45
Pressure (bar)	120
Weight (kg)	16.5
Wetted parts	Stainless steel and PTFE
Room temperature (°C)	40° maxi

ONE PASS HEATER PART NUMBERS

Stainless steel One-pass heater	Voltage / Power		Temperature (°C)	Cable length w/o plug (m)	Fitting		Part number
	Volt	Watt			Inlet	Outlet	
One-pass  230V	230	1400	15 - 45	5	M 1/2 JIC	M 1/2 JIC	056.152.110
One-pass  115V	115	1400	15 - 45	5	M 1/2 JIC	M 1/2 JIC	056.151.110

Accessories for hot circulation



Y- FITTING - STAINLESS STEEL

Allowing paint circulation on the gun while maintaining ease of use. Remote set-up possible using an additional hose.

Y-FITTING PART NUMBERS

Description	Fittings on gun	Hoses thread	Part number
Stainless steel Y-fitting - for AIRMIX® guns	F 1/2" JIC	M 1/2" JIC	029.520.500



CIRCULATION VALVE- BARE - STAINLESS STEEL BODY

Allowing paint circulation at the pump bottom (piston pump).
Max. fluid pressure: 240 bar.

STAINLESS STEEL BODY CIRCULATION VALVE PART NUMBERS

Description	Inlet fitting	Outlet fitting	Purge	Part number
Stainless steel circulation valve	F 1/4" NPS	F 1/4" BSP	F 1/8" BSP	149.220.420

STAINLESS STEEL BODY CIRCULATION VALVE - MAINTENANCE KIT PART NUMBERS

Description	Part number
Maintenance kit	049.220.450



CIRCULATION VALVE (FOR SOLVENT-BASED MATERIALS)

Allows you to set the perfect output for circulation.
Max. fluid pressure: 240 bar.

CIRCULATION VALVES PART NUMBERS (NON STAINLESS STEELS)

Pump intake	Thread		Back fitting	Flushing valve	Flushing rod M 18 x 125	Part number
	Rod					
F 26 x 125	M 26 x 125		M 1/2 JIC	●	●	051.314.010
M 1" G	M 35 x 150		M 3/4 JIC	●	●	051.341.100



PRESSURE REGULATOR - BACK - AIRMIX®

SPECIFICATIONS

Pressure range (bar)	Inlet	120 max
	Regulated outlet	10 - 120
Weight (kg)		3.6
Width (cm)		8.9
Height (cm)		20
Wetted parts		Stainless steel, PTFE, carbide

FITTINGS

Fitting	Fluid Inlet	F 3/8" NPS
	Fluid Outlet	F 3/8" NPS

CONFIGURATION

Set-up	Fitting (suction)	Part number
Manual regulator 120 - 10 / 120	-	155.271.835
Manual regulator 120 - 10 / 120 Equipped for wall-mounting, supplied with 2m fluid hose and fittings for pump suction	26 x 125	051.314.030
Wall bracket		155.484.010

CTM color change valves

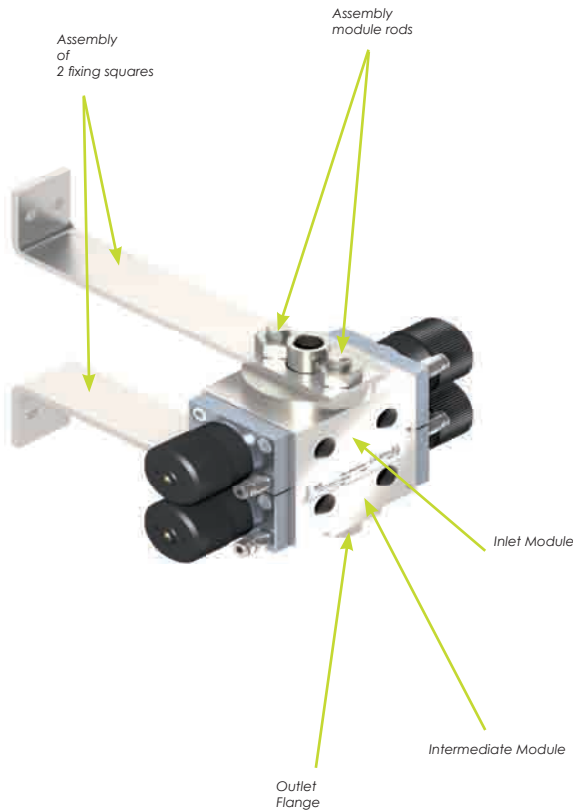

CTM are designed for a rapid color change.

- Two valves per module (the solvent valve should be facing the fluid outlet)
- No dead zone inside CTM reducing flushing time and solvent consumption
- PTFE seals
- Design allows for modular expansion
- Monostable valve normally closed
- Visual Opening detector

For a complete assembly and upon the number of colors:

- Up to 2 colors, you need a 1 module solution made of: 1 inlet module (155.535.100) + 1 outlet flange (155.535.500) + 1 fixing squares kit (155.535.700) + 1 rods kit (155.535.610)
- Up to 4 colors, you need a 2 modules solution made of: 1 inlet module (155.535.100) + 1 outlet flange (155.535.500) + 1 fixing squares kit (155.535.700) + 1 rods kit (155.535.620) + 1 intermediate module (155.535.200)
- Up to 6 colors, you need a 3 modules solution made of: 1 inlet module (155.535.100) + 1 outlet flange (155.535.500) + 1 fixing squares kit (155.535.700) + 1 rods kit (155.535.630) + 2 intermediate module (2 x 155.535.200)
- Up to 8 colours, you need a 4 modules solution made of: 1 inlet module (155.535.100) + 1 outlet flange (155.535.500) + 1 fixing squares kit (155.535.700) + 1 rods kit (155.535.640) + 3 intermediate module (3 x 155.535.200)
- Up to 10 colours, you need a 5 modules solution made of: 1 inlet module (155.535.100) + 1 outlet flange (155.535.500) + 1 fixing squares kit (155.535.700) + 1 rods kit (155.535.650) + 4 intermediate module (4 x 155.535.200)

CTM VALVE SPECIFICATIONS

Designation	AIRMIX®
Max pressure (bar)	120-200
Ø of passage (mm)	6
Trigger air	for hose 2.7 x 4
Fluid inlet	F 1/4 NPS
Fluid outlet	F 1/4 NPS

CONFIGURATION CTM VALVES

Description	Part number
End module (inlet) - 120 bar	155.535.300
Intermediate module - 120 bar	155.535.400
End module (inlet) - 200 bar	155.535.350
Intermediate module - 200 bar	155.535.450
Outlet flange	155.535.500
End module (inlet) - stainless steel (316 L) - 200 bar	155.536.200
Intermediate module - stainless steel (316 L) - 200 bar	155.536.320
Outlet flange - stainless steel (316 L)	155.535.410

Assembly module rods comes with outlet module:

Rod assembly 1 module (1 end + 1 flange)	155.535.610
Rod assembly 2 modules (1 end + 1 intermediate + 1 flange)	155.535.620
Rod assembly 3 modules (1 end + 2 intermediate + 1 flange)	155.535.630
Rod assembly 4 modules (1 end + 3 intermediate + 1 flange)	155.535.640
Rod assembly 5 modules (1 end + 4 intermediate + 1 flange)	155.535.650
Assembly of 2 fixing squares	155.535.700

Pressure regulators

PRESSURE REGULATOR - MANUAL CONTROL - AIRMIX®

AIRMIX® fluid regulator is designed for low viscosity materials.



CHARACTERISTICS

Pressure range (bar)	Inlet	250 max
	Outlet (upon version)	10 - 70; 10-120
Weight (kg)		3.6
Width (cm)		8.9
Height (cm)		20
Wetted parts		Stainless steel, PTFE, carbide

FITTINGS

Fitting	Fluid Inlet	F 3/8" NPS
	Fluid Outlet	F 3/8" NPS

CONFIGURATION

Description	Part number
Manual regulator 250 - 10 / 70 bar	155.271.730
Manual regulator 250 - 10 / 120 bar	155.271.735
Manual regulator PH 250 - 10 / 120 bar	155.271.770
Options:	
Wall bracket	155.484.010

PRESSURE REGULATOR - PILOTED - AIRMIX®

AIRMIX® fluid regulator is designed for low viscosity materials. The piloted version features an increased regulation accuracy and a remote control.



SPECIFICATIONS

Pressure range (bar)	Inlet (upon version): 120 max (version 5-40) or 250 max (versions 10-70 and 10-120)
	Outlet (upon version): 05-40; 10-70; 10-120
Weight (kg) (max: 10-120 version)	4.1 (max: version 10-120)
Width (cm) - w/o pilot	8.9
Height (cm) - (max: 10-120 version)	27.5
Wetted parts	Stainless steel, PTFE, carbide

FITTINGS

Fitting	Fluid Inlet	F 3/8" NPS
	Fluid Outlet	F 3/8" NPS
	Air Inlet (pilotage)	F 1/4" BSP

CONFIGURATION OF PILOTED REGULATOR WITH/WITHOUT PILOT

Description	Part number
Piloted regulator with pilot 120 - 5/40 bar	155.271.765
Piloted regulator with pilot 250 - 10 / 70 bar	155.271.750
Piloted regulator with pilot 250 - 10 / 120 bar	155.271.755
Piloted regulator without pilot 120 - 5 / 40 bar	155.271.760
Piloted regulator without pilot 250 - 10 / 70 bar	155.271.740
Piloted regulator without pilot 250 - 10 / 120 bar	155.271.745

CONFIGURATION OF CARTRIDGE PILOTED REGULATORS WITHOUT PILOT

Description	Part number
Cartridge piloted regulator 120 - 5 / 40	155.271.719
Cartridge piloted regulator 250 - 10 / 70	155.271.715
Cartridge piloted regulator 250 - 10 / 160	155.271.716

PRESSURE REGULATOR - PILOTED - AIRMIX®

ACCESSOIRES

Description	Part number
Wall bracket	155.484.010



HIGH PRESSURE GAUGES

Metal pressure gauge with glass and glycerin lens; totally impact and solvent resistant.

HIGH PRESSURE GAUGES

Description	Pressure range (bar)	Fitting	Internal diameter (mm)	Part number
Diaphragm high pressure gauge (Y mounted)	0 - 250	M 3/8" NPS - F 3/8" NPS	50	155.271.790
Pressure gauge side inlet	0 - 120	M 1/4 G	63	910.010.802
Pressure gauge side inlet	0 - 400	M 1/4 G	63	910.010.801

FILTER

EQUIPPED FILTER

Description	Maximum fluid pressure (bar)	Stainless steel screen for filter	Thread			Part number
			Inlet	Outlet	Drain	
3/8" stainless steel filter	360	-	F 3/8" NPT	F 3/8" NPT	F 1/4" NPT Embase (x1)	155.580.200
Stainless steel Accumulator filter 3/8"	250	6	F 3/8" NPT	M 1/2" JIC	M 18x125	155.580.300
Stainless steel Accumulator filter 3/8"	250	12	F 3/8" NPT	M 1/2" JIC	M 18x125	155.580.400
Stainless steel Accumulator filter 3/8"	250	6	F 3/8" NPT	M 1/2" JIC	M 18x125	155.580.600

ACCESSORIES FOR FILTERS

Description	Part number
Stainless steel filter fitting length 70 mm (MM 3/8" NPT)	055.580.301
Wall-mounted bracket and screws for 3/8", 3/4" and 1" filter with 9 digits part numbers	155.190.105

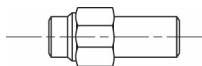

INLINE FLUID FILTERS 200 BAR

Fluid filtration is of the utmost importance in the prevention of spray gun wear; it also avoids all unnecessary line down time due to blockages.

FILTER CONFIGURATION

Description	Maximum fluid pressure (bar)	Stainless steel screen for filter	Average output (l/mn)	Thread		Part number
				Inlet	Outlet	
(1) Medium pressure stainless steel filter	200	6	2	F 1/4 NPS	F 1/4 NPS	055.600.000

STRAINERS FOR SUCTION RODS
STRAINERS CONFIGURATION

Pump	Height (mm)	External diameter (mm)	Material	Filtration size		Part number
				Micron	Mesh	
10.14	60	40	Polyamide	300	50	051.531.600
15-C25/30-C25 (Ø16)	32.5	28	Stainless steel	1000	15	149.596.052
30.C25 10.25/17. A2/20.25/20.25F/34.A2/40.2 5/40.25F/08.120/08.120F/16. 120/16.120F (Ø25)	40	48	Stainless steel	1000	15	149.596.152
40.25/40.50WB (Ø25)	40	48	Stainless steel	1000	15	921.270.102
40.130-2 / 40.130 F2 / 65.130 / 65.130 F2 / 20.25 (old generation) (Ø25)	112	66	Polyamide	1000	15	149.591.400

SCREENS AND CARTRIDGES FOR PRODUCT FILTER
SCREEN CONFIGURATION (FILTRATION SURFACE 65 CM²)

Filter number	Filtration size		Nozzle size	Part number
	Micron	Mesh		
1	40	325	3	000.161.101
2	74	200	4	000.161.102
3	90	170	4	000.161.103
4	100	140	4	000.161.104
6	168	85	6	000.161.106
8	210	70	09 & 14	000.161.108
12	280	55	20	000.161.112
15	360	45	30 & 45	000.161.115
20	510	30	≥ 68	000.161.020
30	750	20	≥ 68	000.161.030

(1)

Cyclix™ agitators for 20-40-200 l drums



This elevator-agitator for 20-40 to 200l drums features a double-effect jack for a fast lift of a stainless steel cover fitted for a quick material drum change. The cover is equipped with a motorized agitator fitted with blades for low viscosity materials and a full stainless steel rod.

The elevator is coming on a large fixing plate which makes it very stable and easy to install in paint kitchens, existing installations or an essential component of new installations.

FEATURES

Stainless steel (agitator cover, suction and drain rods)
 Adjustable suction rod height
 Suction and return tubes
 Double effect jack with 3 positions
 command lever: up, stop, down
 The agitator cannot work during elevator movements

BENEFITS

Compatibility with all materials
 No product loss
 Suitable for recirculating
 Important flexibility
 Security

CHARACTERISTICS

Capacity (L)	20 - 40	200
Motor type	Pneumatic	Pneumatic
Reductor type	-	Gear train
Rotation speed (rpm)	60 - 300	5 - 90
Motor torque	Nm	2.2
		34

CYCLIX™ PART NUMBERS FOR 20 - 40 L DRUMS

Description	Elevator height (mm)	Agitator rod length (mm)	Paddle diameter (mm)	Cover diameter (mm)	Part number
Elevator for 20 -40 l drums	1024 (min) - 1500 (max)	-	-	-	151.081.000
Agitator for 20 -40 l drums	-	400	134	-	154.261.700
Cover for 20 -40 l drums	-	-	-	400	154.261.600
Suction/exhaust kit	-	-	-	-	154.261.800

CYCLIX™ PART NUMBERS FOR 200 L DRUMS

Description	Elevator height (mm)	Agitator rod length (mm)	Paddle diameter (mm)	Cover diameter (mm)	Part number
Elevator for 200 l drums	1510 (mini) - 2410 (maxi)	-	-	-	151.091.000
Agitator for 200 l drums	-	800	370	-	154.261.300
Cover for 200 l drums	-	-	-	635	154.261.200
Suction/exhaust kit	-	-	-	-	154.261.400

RECOMMENDED ACCESSORIES

Description	Part number
1/4" air lubricator + support	154.261.997
Exhaust assembly with oil recovery (length 1 m)	154.261.996
Air feeding kit	154.261.930
Drum roller unit for 200 litres drum	151.098.100
Slotted paddle for thick materials	154.261.952
HP 150 2 liters lubricant can	149.990.017

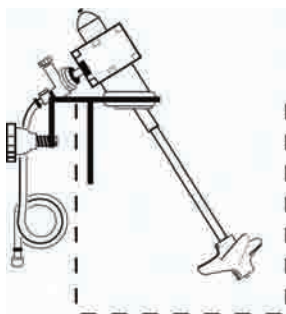

AGITATORS FOR EDGE PAIL MOUNTING

Agitator for barrel edge mounting.
Minimum barrell height of 300 mm.

AGITATORS

Description	Part number
Bare agitator	051.332.610
Agitator with 25 cm hose	051.332.600
Agitator with 5 m hose	049.220.710
System for barrel mounting	049.220.720



AGITATORS ON STAINLESS STEEL COVER

Agitator:
For drums diameter between 295 and 325 mm.
Minimum drum height of 390 mm.

AGITATORS

Description	Part number
Agitator for Ø325 cover	903.290.101

STRAINER FOR CYCLIX™ SUCTION RODS

STRAINER FOR CYCLIX™ SUCTION RODS

Description	Part number
Strainer for cyclix™ suction rods	154.261.940

FLUID HOSES FOR AIRMIX® SPRAYING

The hoses should be chosen according to the pressure used in the application and electrical conductivity.



HOSES CONFIGURATION

Designation	Part number						
	NO			YES			
Conductive	GREY			BLUE			
Color	NOIR			NOIR			
Internal diameter mm	3.2 (1/8")	4.8 (3/16")	6.35 (1/4")	3.2 (1/8")	4.8 (3/16")	6.35 (1/4")	6.35 (1/4")
Max. operating pressure bar	120			240		450	
Temperature	up to 100°C						
25 m	050.450.059	050.450.060	050.450.070	-	-	-	-
100 m	-	050.450.061	050.450.071	-	-	-	-
300 m	-	050.450.064	050.450.072	-	-	-	-
Fitting alone to crimp	-	905.063.304	-	-	-	-	-
Fitting alone to screw in	-	905.063.308	905.063.309	-	-	-	-
Fitting alone stainless steel to crimp	905.063.359	905.063.354	905.063.355	-	-	-	-
Fitting alone stainless steel to screw in	905.063.356	905.063.358	905.063.357	-	-	-	-
Spring for fitting to crimp	-	905.063.361	-	-	-	-	-

PART NUMBER ACCORDING TO LENGTH WITH FITTINGS per meter

	1/2 JIC					
	Treated Stainless Steel Fittings					
A and B fittings (free nut)	With spring	Without spring	Without spring	With spring	Without spring	
0.4 m	-	-	-	-	050.450.101	-
0.6 m	-	050.450.805	050.450.701	-	050.450.106	-
0.8 m	-	-	050.450.702	-	050.450.107	-
1 m	-	050.450.809	050.450.703	-	050.450.601	050.451.001
2 m	-	050.450.806	050.450.704	-	050.450.602	050.450.109
3 m	-	050.450.810	050.450.705	-	050.450.603	050.450.110
5 m	-	050.450.801	050.450.706	-	050.450.604	050.450.108
7.5 m	-	050.450.808	-	-	050.450.605	050.450.111
10 m	-	050.450.802	050.450.707	-	050.450.606	050.450.104
15 m	-	050.450.811	050.450.709	-	050.450.607	050.450.112
20 m	-	050.450.812	050.450.708	-	050.450.608	050.450.105
25 m	-	-	-	-	050.450.113	-
30 m	-	-	050.450.710	-	050.450.609	-

Stainless Steel Fittings					
	With spring	Without spring	Without spring	With spring	Without spring
0.6 m	-	050.450.851	-	050.450.651	-
1 m	-	-	050.451.151	-	-
5 m	-	050.450.852	-	050.450.652	050.450.152
7.5 m	-	050.450.853	-	050.451.153	050.450.153
10 m	-	-	050.451.154	-	050.450.154

PRODUCT HOSES FOR SUCTION ROD

HOSE FOR SUCTION ROD

Designation	Part number		
	Ø 9.5 mm	Ø 19 mm	Ø 25 mm
Polyethylene hose sleeve			
5 m cut	050.361.005	050.366.051	050.367.001
15 m cut	050.361.004	050.366.052	-
25 m cut	050.361.001	050.366.053	050.367.003
Grooved conical fitting	050.140.517	050.140.545	050.140.543
Nickeled nut fitting	050.271.303	050.271.502	049.595.306
1 wing collar	906.311.234	906.311.207	906.311.204

AIR HOSES

Used in majority of the applications, allows the equipment (gun and pump) to have the same potential, ATEX certified.



HOSES CONFIGURATION

Available in 3 diameters:	Small	Medium	Big
Technical Characteristics			
Material	TPU*	TPU*	Nitrile
Color	Black	Black	Black
Internal Diameter (mm)	6.5	8	10
External Diameter (mm)	10.5	12	16
Conductor	Yes	Yes	Yes
Weight (grams per meter)	61	75	130
Max operating pressure in bar	14	14	10
Operating temperature in °C	-40 to 80	-40 to 80	up to 60
Hoses with fittings			
Fittings	1/4" NPS		3/8" NPS
0.6m	050382105	050389109	-
1.2m	050382102	050389107	-
2m	050382111	050389110	-
5m	050382109	050389101	050381101
7.5m	050382114	050389103	-
10m	050382110	050389102	050381102
12.5m	050382106	-	-
15m	050382116	-	-
20m	-	050389108	-
30m	-	050389106	-
Hoses without fittings			
25m	050382001	050389001	050381001
152m	050382006	050389005	-
250m	050382007	050389006	-
Fittings			
Hose crimp ring	906311237	906311238	906311226
KIT STRAIGHT CONN. + NUT 1/4 NPS	050231705	050231707	050231702
	fitting = 1 crimp ring + 1 kit		
Manual Crimper (Diameters 5 to 22)	906311202		

* TPU : Thermoplastic Polyurethane

POLYAMIDE OR POLYURETHANE AIR HOSES

Non-conductive hoses to clip on automatic guns or any other device.

POLYAMIDE OR POLYURETHANE AIR HOSES

Conductive	No						
Max operating pressure	10 Bar						
Temperature	Up to 60°C						
Length	25m						
Material	Polyamide				Polyurethane		
Color	translucent		black	blue	black		
Diameter (internal/external) in mm	2.7 x 4	4x6	6x8	8x10	4x6	6x8	8x12
Reference	050372102	050372103	050372104	050372125	050372213	050372214	050372226

HOSE SLEEVE

Hose sleeve adds a protection to the hose for a longer life

HOSE SLEEVE

product hole (mm)	length (m)	Reference
40	10	129270087

LUBRICANTS AND GREASES FOR PUMPS
LUBRICANT FOR PUMP PACKINGS



Description	Part number
Lubricants for pump fittings	
T lubricant (125 ml) can for solvent-based paints	149.990.020
Kit of 3 T lubricant cans (2L each)	151.260.820
P lubricant can (2L each) (PU products)	149.990.022
Kit of 3 P lubricant cans (2L each) (PU products)	151.260.823
Grease	
Vaseline 1 kg	560.440.002
Box of 450 g PTFE grease	560.440.001
Box of 1kg grease special air motor seals	560.440.001
Tube 20g grease special air motor seals	560.440.005
Teflon® grease tube 10 ml	560.440.105
Box of grease (450g)	560.420.005
Glue	
Sealing glue tube	554.180.015
Low strength anaerobic adhesive tube	554.180.010

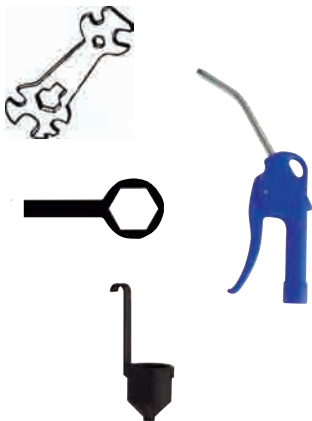

MISCELLANEOUS
PART NUMBERS

Description	Part number
M22/Xcite™ gun wrench	049.030.042
Large size brush	906.300.101
Small size brush	906.300.102
Wrench for product filters	049.030.018
Large blow gun	129.371.000
Viscosity cup N° 4 CA4	049.221.400
Thickness gauge from 25 to 2000µ	000.790.020
Adhesive-roller with Sames Kremlin logo (75mm x 100m)	571.141.003

RC 600 full visor mask

Maximum protection for excellent working conditions, optimal health protection with low operating costs. The RC 600 is compliant with the latest european norms.



FEATURES

- Complete assembly with protection screen
- Light and ergonomic
- Low airflow alarm
- Adjustable head and front protection
- Easy disposable screen protectors

BENEFITS

- Complete protection of the operator face and eyes (against isocyanates especially)
- Reduced fatigue and excellent working conditions for increased productivity
- Constant operator protection
- Suitable for everyone and user-friendly
- Easy maintenance

CONFIGURATION OF THE RC 600 FULL-VISOR MASK

Description	Part number
RC 600 full-visor mask complete	143.400.000
Belt supply air hose assembly	143.400.002

ACCESSORIES

Description	Quantity	Part number
RC 600 full-visor mask alone (without regulator)	1	143.400.007
Screen protector	50	143.400.006

RC 756 respirators

Lightweight, comfortable respirators efficient for each type of paint and compliant with the latest european norms (Respirator: EN 140, Filters: EN 14393).



FEATURES

Respirator body made of silicone
 Equipped with large inlet and outlet valves
 Double fixing straps
 Double filters
 Three high performance filters type available (solvented, water-based or multi with isocyanate materials)

BENEFITS

Hypoallergenic and high comfort
 Easy breathing
 Comfortable
 Performance (large diameter), visibility and high level of safety
 For an optimal protection whatever the type of paint used

CONFIGURATION OF THE RC 756 RESPIRATOR

Description	Part number
RC 756 respirator	143.380.100
RC 756 respirator for SOLVENT-BASED PAINTS - A1 filters	143.380.200
RC 756 respirator for WATER-BASED PAINTS - A1B1P3 filters	143.380.300
RC 756 respirator for PLURAL COMPONENT PAINTS - ISOCYANATES - A1B1E1K1P3 filters	143.380.400

FILTERS & PRE-FILTERS

Description	Type	Quantity	Part number
Filters for solvented paints	A1	10	143.380.210
Filters for water-based paints	A1B1P3	5	143.380.310
Filters for plural-components-isocyanates	A1B1E1K1P3	5	143.380.410
Pre-filters for A1 filters	-	25	143.380.110

ACCESSORIES

Description	Quantity	Part number
Attach strap	1	143.380.120
Spare inlet/outlet valves	3	143.380.130



PROTECTIVE OVERALLS

Protects the operator. Comfortable to wear, giving protection for dust or plush.

- Conforms to European Standards
- Made in non-woven fabric, they come with elasticated wrists and wide trouser legs to protect footwear

PART NUMBERS

Description	Size	Quantity	Part number
Overalls Size S for 5 sets	S	5	564.504.001
Overalls Size M for 5 sets	M	5	564.504.002
Overalls Size L for 5 sets	L	5	564.504.003
Overalls Size XL for 5 sets	XL	5	564.504.004
Overalls Size XXL for 5 sets	XXL	5	564.504.005



PROTECTIVE HOOD

Protects the head and hair.

- Non-woven, light and lets the skin breathe
- Conforms to European Standards

PART NUMBERS

Description	Quantity	Part number
Protective hood	5	043.250.001

NOTES

Area with horizontal dashed lines for taking notes.

Airmix® spraying

Plural component pumps and machines

Fittings and air treatment

NOTES

Area with horizontal dashed lines for taking notes.

PLURAL COMPONENT PUMPS AND MACHINES

Airmix® spraying

Plural component pumps and machines

Fittings and air treatment

PU 2160 F pump

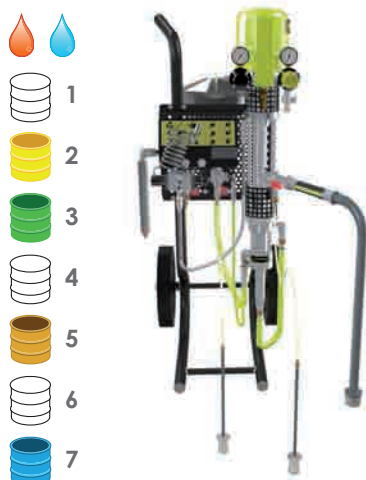

The Flowmax® technology, a Sames Kremlin patented SuperLife™ bellow design, ensures a perfect mixing accuracy thanks to the total sealing without packings. Fixed ratio: the economical and easy solution while benefitting from the Airmix® spraying.

PU 2160 F are tested and comes complete ready for use. PU 2160F are available in 4 mixing ratio versions: 1/1, 2/1, 5/1 or 10/1.

FEATURES

BENEFITS

Cart-mounted pump	Easy positioning in the working area (various working areas)
Comes with mixer, mix manifold, air feeding assembly, suction rod for base and flushing solvent, 6 L catalyst gravity tank	Ready to use pump
Stainless steel fluid sections (base and catalyst) - in standard	Chemical compatibility w/o any risk of corrosion with water-based materials
Sealing done by a FLOWMAX® bellow on the catalyst side	High reliability No more lubricant cups Leak free Total sealing between pump and its environment, ideal to work with moisture-sensitive catalysts Ideal for UV and pre-catalyzed materials
Semi-automatic manifold with synoptic	Safe operation User-friendly
Catalyst re-circulation	Quick color change and flushing without catalyst loss
Complete stainless steel 316 catalyst circuit on 10/1 pressure ratio version	Ideal for chemically aggressive catalysts

SPECIFICATIONS

Mixing ratio (upon version)	1/1 - 2/1 - 5/1 - 10/1
Pressure ratio	10/1 - 15/1 - 18/1 - 20/1
Max Fluid viscosity in CA 4	180 s
Maximum air inlet pressure (bar)	6
Balanced acoustic pressure (dBA)	80
Weight (kg)	60
Wetted parts	Stainless steel, polyethylene, PTFE, nickel-coated steel Catalyst fluid section 1/1, 2/1 and 5/1: 304 stainless steel, 10/1: 316L stainless steel

DOSING RATIO

Description	Volumic dosing ratio	Fluid Output at 20 Cycles/mn (l/mn)	Pressure ratio	Fluid pressure (upon air motor pressure)	
				4 bar	6 bar
PU 2160 F 1/1	1/1	0.8	10/1	40	60
PU 2160 F 2/1	2/1	0.6	15/1	60	90
PU 2160 F 5/1	5/1	0.5	18/1	72	108
PU 2160 F 10/1	10/1	0.44	20/1	80	120

PU 2160 F pump

FITTINGS

Fitting	Air inlet (valve)	F 3/8" BSP
	Air outlet (atomization air)	M 1/4" NPS
	Fluid Outlet	M 1/2" JIC

PU 2160F PART NUMBERS

Description	Part number
PU 2160 F pump - cart-mounted - pressure ratio 1/1	151.586.690
PU 2160 F pump - cart-mounted - pressure ratio 2/1	151.586.695
PU 2160 F pump - cart-mounted - pressure ratio 5/1	151.586.710
PU 2160 F pump - cart-mounted - pressure ratio 10/1	151.586.700

PU 3000 2l and 4l

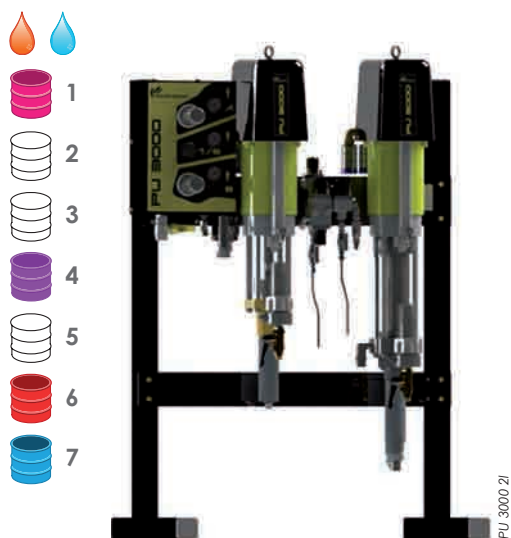

The PU 3000, innovative economical and patented solution, combines electronic control and mechanical metering, ready to use.

The user-friendly control box allows the operator to intuitively learn how to operate the machine.

PATENTED : The innovative pump change-over - FREE PULSE ELECTRONIC technology (FPE) - features a perfectly constant output and a +/- 1% metering accuracy for an outstanding finish and operator peace of mind. Electronic dosing constantly monitors the actual material consumption of products and calculates the VOC.

The machine can be installed in an ATEX 1 or 2 zone to be in close proximity to the operator. The control box must be installed in safe zone (ATEX Directive).

PU 3000 2l is available in AIRMIX® versions.
PU 3000 4l is available in AIRMIX® versions.



PU 3000 4l



FEATURES

BENEFITS

Plug & Spray	Quick start-up
Sames Kremlin patent: Free Pulse Electronic Control (FPE)	Constant fluid flowrate
Innovative control system of pump change-over	Unsurpassed +/- 1% mixing accuracy and +/- 1% repeatability
Direct injection in the high performance static mixer	Perfect mixing
Recording of fluid consumptions and VOC Possibility to print records	Fluid and solvent consumptions stored in memory
Automatic component management: base, catalyst and solvent	User friendly
Automatic flushing and material generation	User-friendly and easy programming for the operator
User-friendly control panel	
Preventive maintenance alarm	Safe operation
Continuous ratio checking and alarm	
Low level drum alarm	
Ratio check kit in standart with 2 liters test tube	Visual control of mixing accuracy
Filter and drain assembly in standart	No product loss
Sealing done by a FLOWMAX® bellow on the catalyst side	High reliability
	Total sealing between pump and its environment, ideal to work with moisture-sensitive catalysts
Wide range of ratio from 5 to 160%	Suitable for use on a wide range of markets
Suitable for AIRMIX® spraying technologies	
Very low flow rate from 10cc	

SPECIFICATIONS

Electrical Power	115/230V - 75W
Maximum air inlet pressure (bar)	6
Fluid viscosity	30 - 8000 cps
Mixing accuracy	+/- 1%
Mixed fluid output	PU 3000 2l: 10cc at 2000 cc / min PU 3000 4l: 50cc at 4000 cc / mm
Mixing ratio	1/1 - 20/1 (100% - 5%)
Wetted parts	Stainless Steel and PEHD

PU 3000 2l and 4l

TECHNICAL CHARACTERISTICS

Description	Pressure ratio	Air motor type	Maximum fluid pressure (bar)
PU 3000 - AIRMIX®	30 / 1	3000	200

PU 3000 DIMENSIONS

Description	Height (cm)	Depth (cm)	Width (cm)
AIRMIX® version	PU 3000 2l: 130 PU 3000 4l: 150	70	86
Control Box	28.6	14.3	36.7

FITTING

Fitting	Air inlet (valve)	F 3/4" BSP
	Air Outlet	F 1/4" BSP
	Fluid Outlet	F 3/4 JIC

PU 3000 2L PART NUMBERS

Description	Part number
PU 3000 - AIRMIX® version - 100cc - 2l - Flowmax	155.680.110

PU 3000 4L PART NUMBERS

Description	Part number
PU 3000 - AIRMIX® version - 227cc - 4l	155.680.155

PU 3000 OPTION PART NUMBERS

Description	Part number
Spray booth glass mounting kit	155.660.340

PU 3000 FLUSHING PUMPS PART NUMBERS

Description	Suction rod	Purge rod	Air regulator fluid pressure	Filter	Part number
30-C25 flushing pump - PU 3000	● (Ø 16)	-	-	-	151.145.090

CYCLOMIX™ Micro and Micro+ PH



Supplied without pumps or guns to be ordered separately
Designed to supply one gun only

User-friendly precise and control mixing of 2 components materials. With CYCLOMIX™ Micro, the mixing process is mastered and guaranteed. All technical fluid and application characteristics are fully configurable. Once programmed, CYCLOMIX™ Micro will automatically handle all parameters. The programming is user-friendly and quick, with data in-putting by magnetic signal. Flushing and maintenance are very simple. In addition, the system can be controlled from inside the booth. CYCLOMIX™ Micro+ allows the flushing of the catalyst fluid passages especially for water-based materials. For acid catalyst it exists specific references for a CYCLOMIX™ Micro+ PH. Safe zone installation where applicable (Directive ATEX).

FEATURES

BENEFITS

Automatic component management: base, catalyst and solvent	Dosing +/- 1% and repeatability +/- 0.5%
Automatic flushing and material generation	Quick start-up. Minimal material and solvent wastage.
Adjustable flushing volume Several flushing sequence available: only Base side; Base side then Catalyst; Catalyst side then Base side	Solvent savings and environmental protection
Continuous ratio checking and alarm	The paint applied on parts always conforms to specifications
User-friendly control panel	User-friendly and easy programming for the operator
Stainless steel design	To handle a wide range of materials
Recording of fluid consumptions and VOC with the possibility to print records (with RS 232 option)	Fluid and solvent consumptions stored in memory
Possibility to monitor the Cyclomix™ Micro from the spray booth (with the glass kit option)	Ergonomy of the working station
Design of the mixing plate	Easy maintenance and spare parts standardization

SPECIFICATIONS

Electrical Power	115 / 230V - 75W
Trigger air pressure (bar mini)	4
Product pressure (bar)	2 -175
Weight (kg)	25
Wetted parts	Stainless steel and PEHD 316L stainless steel on PH version catalyst side
Mixing ratio	single component and 0,6/1 to 20/1
Mixing accuracy	1%
Maximum number of gun to be fitted	1
Mixed fluid output	100 - 2000 cm³/mn
Fluid viscosity	30 - 5000 cps
height (cm)	17.3 (command cabinet) - 40 (dosing unit)
Width (cm)	36.6 (command cabinet) - 40.7 (dosing unit)
Depth (cm)	11.1 (command cabinet) - 30 (dosing unit)

FITTINGS

Description	Fitting
Electrical supply: bornier and stuffing box	
Air supply	F 1/4" BSP
Air outlet	F 1/4" BSP
Fluid supply	M 1/2" JIC
Fluid outlet	M 1/2" JIC

CYCLOMIX™ MICRO, MICRO+ AND MICRO+ PH PART NUMBERS

Description	Catalyst fluid passage flushing	Number of bases	Number of catalysts	Part number
CYCLOMIX™ Micro	-	1	1	155.660.900
CYCLOMIX™ Micro	-	3	1	155.660.930
CYCLOMIX™ Micro+	●	1	1	155.660.911
CYCLOMIX™ Micro+	●	3	1	155.660.933
CYCLOMIX™ Micro+ PH (without mixer - see options)	●	1	1	155.660.951
CYCLOMIX™ Micro+ PH	●	3	1	155.660.953

OPTIONS CYCLOMIX™ MICRO, MICRO+ AND MICRO+ PH PART NUMBERS

Description	Part number
Mixing assembly for Cyclomix® Micro+ PH	155.660.955
RS 232 connection kit for printer	155.660.935
Spray booth glass mounting kit	155.660.340
5m extension cable between control cabinet and mixing panel	901.250.216

CYCLOMIX™ Multi and Multi PH



Supplied without pumps or guns to be ordered separately
Designed to supply one gun only

CYCLOMIX™ electronic dosing to handle several colors: CYCLOMIX™ Multi can handle up to 7 different bases and 3 catalysts.

Modular design CYCLOMIX™ Multi can be positioned in zone 1 or 2 (Directive ATEX). The control cabinet must be installed in safe zone (ATEX Directive).

Programming and use are user-friendly by means of a large touch screen.

For acid catalyst it exists specific references for a CYCLOMIX™ Multi PH.

FEATURES

BENEFITS

Automatic component management: base, catalyst and solvent	Dosing +/- 1% and repeatability +/- 0.5%
Automatic mix material fill	Quick start-up. Minimal material and solvent wastage.
Adaptable programming for each color	Ideal application for each color
Several flushing modes: production cycle, extended production stops, solvent-based materials	Perfect compatibility with production conditions evolutions
Fast mixing ratio accuracy by beakers batch mode	Visual control of mixing accuracy To easily get small quantities of mixed materials for touch-up works
Autowash system	Off-production gun automatic monitoring
Multilingual display and integrated instruction manual	User-friendly and easy programming for the operator
Stainless steel design	Compatible with water-based materials
Numerical interface	Quick link with an on-line automate
Integrated spraying air management	Comfort and safety during color and solvent fill
Pneumatic emergency flushing	Perfect flushing in case of power supply cut-off
Design of the mixing plate	Easy maintenance and spare parts standardization
Robotic interface	Connection with an on-line automate

SPECIFICATIONS

Electrical Power	115 / 230 V - 75 W
Trigger air pressure (bar mini)	4
Product pressure (bar)	2 - 200 bar
Weight (kg)	70
Wetted parts	Stainless steel and PeHD
Mixing ratio	0.6/1 to 20/1 (160% to 5%)
Mixing accuracy	+/- 1%
Maximum number of gun to be fitted	1
Solvent flowrate (m³/h)	100 - 2000 cm³/mn
Mixed fluid output	100 - 2000 cm³/mn
Fluid viscosity	30 - 5000 cps
height (cm)	60 (control cabinet) - 77 (mixing unit)
Width (cm)	60 (control cabinet) - 60 (mixing unit)
Depth (cm)	40 (control cabinet) - 77 (mixing unit)

FITTINGS

Description	Fitting
Air supply	F 1/4" BSP
Air outlet	F 1/4" BSP
Fluid supply	M 1/2" JIC
Fluid outlet	F 1/4" BSP

CYCLOMIX™ MULTI PART NUMBERS

Description	Number of bases	Number of catalysts	Part number
CYCLOMIX™ Multi	3	1	155.660.813
CYCLOMIX™ Multi	5	1	155.660.815
CYCLOMIX™ Multi	7	1	155.660.817
CYCLOMIX™ Multi	3	2	155.660.823
CYCLOMIX™ Multi	5	2	155.660.825
CYCLOMIX™ Multi	3	3	155.660.833
CYCLOMIX™ Multi PH	3	1	155.660.513
CYCLOMIX™ Multi PH	5	1	155.660.515
CYCLOMIX™ Multi PH	7	1	155.660.517

OPTION PART NUMBER CYCLOMIX™ MULTI

Description	Part number
Autowash	155.660.300

CYCLOMIX™ Expert

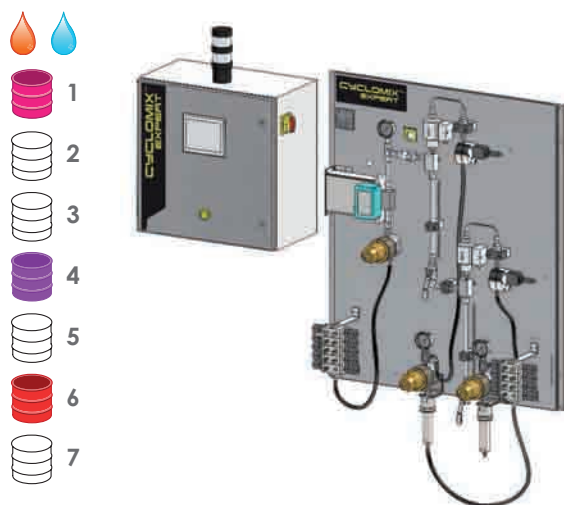

Supplied without pumps or guns to be ordered separately

Cyclomix™ EXPERT, industrial and evolutive solution, innovative, guarantees total quality of production.

CYCLOMIX™ Expert can manage a total up to 24 components (bases, catalysts, flushing solvents). It can handle mono, bi or tri-component materials.

The innovative dosing process - ultra fast injection valve - offers unequalled mixing quality and dosing accuracy. The machine can handle 2 working stations at the same time. The machine programming by means of a color screen with ratio/tolerance data assist management - up to 15 languages - has been designed to bring comfort and easiness in the case of product or parameters modifications. The electronic technology brings total monitoring and follow-up of real material consumptions, VOC with recording possibility to ensure tracability.

CYCLOMIX™ Expert can be fitted with different flowmeters technologies (ex: mass flowmeter for difficult paint to handle or water-based materials). The possibility to use Flowmax® technology - developed by KREMLIN REXSON - bellows instead of traditional packings on the catalyst side brings total reliability for moisture-sensitive isocyanates catalysts.

CYCLOMIX™ Expert is available in AIRMIX® to meet all market needs, in manual or automatic spraying.

The fluid manifold can be set-up in the spraying area in order to reduce the paint hoses length. Safe zone location (ATEX Directive) for the control cabinet.

Options are available to upgrade the machine depending on each customer configuration.

- Remote color screen control cabinet
Accessible directly from the working station (spray booth), it allows the operator to manage production, color changes, flushing...

- Automatic Flush box
Located in the spraying area closed to the painter, it enables the painter to be hands free while system is flushing.

CYCLOMIX™ Expert

FEATURES	BENEFITS
Automatic component management up to 24 components in 1,2, 3 components and solvent	Innumerable possibilities Flexibility when changing materials
Real time display of instant real ratio and flowrate	Continuous process control
No pre-mixing chamber: optimized fluid passages w/o retention zones	Perfect flushing Prevent fluid waste
Stainless steel design	Compatible with water-based materials
Frequency configuration before flushing at the end of potlife	Mixed material and solvent savings Safe operation
Emergency pneumatic manual flushing	Perfect flushing in case of power supply cut-off
Batch mode	To easily get small quantities of mixed materials for touch-up works
Adaptable programming for each color	Ideal application for each color
3 data access level upon each operator	Safety use
Assisted data and tolerance product manufacturer specification entry	Quick and easy data entry eliminating any errors
Color man/machine interface	User friendly
Standard monitoring of 2 guns (2 priming - 2 flushing)	Possibility to manage 2 workstations simultaneously (1 or 2 guns or both)
Ratio check	Safe operation Full operator safety
6 different flushing sequences (air-solvent es standard) Volume or time flushing Multiples solvent choice for each recipe	Solvent consumption optimization upon recipe Optimized flushing
Magnetic injection volume adjustment - electro magnetic valves	Mixing optimization upon ratios Increase of injection frequency
USB data storage Batch number management	Production Follow-up optimization
Various Product mesurement technology: mass or gear	Handles a large range of materials

Airmix® spraying

Plural component pumps and machines

Fittings and air treatment

SPECIFICATIONS

Voltage (V)	115 - 230
Number of fluid inlets	24
Trigger air pressure (bar mini)	4
Operating pressure (bar)	5 - 200
Mixing ratio (in standard)	0.6/1 at 30/1
Mixing accuracy	+/- 1%
Mixed fluid output	50 - 6000 cm³/mn
Fluid viscosity	30 - 5000 cps
Wetted parts	Stainless steel and PeHD (option 316L)
Width (cm)	100 (3K) - 89 (2K)
Height (cm)	119 (3K) - 91 (2K)
Weight (kg)	48 (2K) - 68 (3K)

CONTROL BOX CHARACTERISTICS

Width (cm)	60
Height (cm)	60
Depth (cm)	40
Weight (kg)	25

CYCLOMIX™ EXPERT PART NUMBER

Description	Part number
CYCLOMIX™ Expert	Please consult us

FITTINGS AND AIR TREATMENT

MALE TO MALE CONNECTION PMAX: 20 BAR

Max Pressure (20 bar)

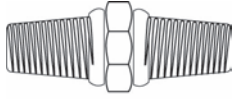

METRICAL FITTINGS - 20 BAR

Male/Male	M 14 x 125	M 18 x 125
M 14 x 125		050.102.133 050.102.142 ⁽¹⁾
M 18 x 125	050.102.133 050.102.142 ⁽¹⁾	050.102.102

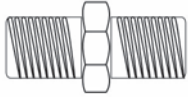

METRICAL ADAPTORS TOWARDS BSP - 20 BAR

Male/Male	M 14 x 125	M 18 x 125	M 26 x 125
G 1/8" (BSP) (5 x 10)	050.102.412		
G 1/4" (BSP) (8 x 13)	050.102.405 050.102.441 ⁽¹⁾	050.102.408 050.102.444 ⁽¹⁾	
G 3/8" (BSP) (12 x 17)	050.102.410	050.102.411 050.102.436 ⁽¹⁾	
G 1/2" (BSP) (15 x 21)	050.102.513	050.102.406 050.102.418 ⁽¹⁾	050.102.402 050.102.437 ⁽¹⁾
G 3/4" (BSP) (20 x 27)		050.102.429	050.102.407

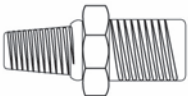

METRICAL ADAPTORS TOWARDS NPT - 20 BAR

Male/Male	M 26 x 125
1/2" NPT	050.102.507

MALE TO MALE CONNECTION PMAX: 60 BAR

FITTINGS BSP (GAZ) - 60 BAR



Male/Male	G 1/8" (5 x 10)	G 1/4" (8 x 13)	G 3/8" (12 x 17)	G 1/2" (15 x 21)	G 3/4" (20 x 27)
G 1/8" (5 x 10)		906.314.207 ⁽¹⁾			
G 1/4" (8 x 13)	906.314.207 ⁽¹⁾	050.102.213 906.314.203 ⁽¹⁾	904.523.003 906.314.204 ⁽¹⁾	050.102.211	
G 3/8" (12 x 17)		904.523.003 906.314.204 ⁽¹⁾	050.102.214 906.314.202 ⁽¹⁾	904.523.006 906.314.205 ⁽¹⁾	
G 1/2" (15 x 21)		050.102.211 050.102.647 ⁽¹⁾	904.523.006 906.314.205 ⁽¹⁾	050.102.212	904.523.012
G 3/4" (20 x 27)				904.523.012	050.102.215

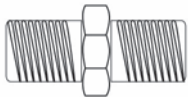

FITTINGS NPT - 60 BAR

Male/Male	1/4" NPT	3/8" NPT
1/4" NPT		905.083.201
3/8" NPT	905.083.201	

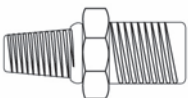

FITTINGS NPS - 60 BAR

Male/Male	1/4" NPS	3/8" NPS
1/4" NPS	050.102.630	050.102.632
3/8" NPS	050.102.632	050.102.631 050.102.652 ⁽¹⁾

ADAPTOR NPS TOWARDS BSP (GAZ) - 60 BAR

Male/Male	1/4" NPS	3/8" NPS
G 1/4" BSP	050.102.624 050.102.644 ⁽¹⁾	050.102.646 ⁽¹⁾
G 3/8" BSP	050.102.627 050.102.647 ⁽¹⁾	050.102.628 050.102.648 ⁽¹⁾
G 1/2" BSP	050.102.633	050.102.629 050.102.649 ⁽¹⁾
G 3/4" BSP		050.102.654 ⁽¹⁾

(1) Stainless steel fittings

FEMALE TO FEMALE CONNECTION

P_{MAX}: 60 BAR

FITTINGS BSP (GAZ) - 60 BAR



Female/Female	G 1/4" (BSP)
G 1/4" (BSP) (8 x 13)	904.593.002
G 3/8" (BSP) (12 x 17)	904.503.003

ADAPTOR BSP (GAZ) TOWARDS METRIC - 20 BAR

Female/Female	G 1/4" (BSP)
M 14 x 125	050.221.401

T FEMALE BSP (GAZ) - 60 BAR

Description	Part number
Fittings 3 x G 1/4" (BSP) (8 x 13)	904.303.002
Fittings 3 x G 3/8" (BSP) (12 x 17)	904.303.003
Fittings 3 x G 1/2" (BSP) (15 x 21)	904.303.004
Fittings 3 x G 3/4" (BSP) (20 x 27)	904.303.006

T FEMALE NPT - 60 BAR

Description	Part number
Fittings 3 x 1/4" NPT	905.083.301

MALE TO FEMALE CONNECTION

P_{MAX}: 20 - 60 BAR

ADAPTOR NPS TOWARDS JIC, NPS AND METRIC - 20 BAR

Male/Female	1/4" NPS	3/8" NPS
1/2" JIC	150.123.305 ⁽¹⁾	050.103.537 ⁽¹⁾
1/4" NPS	-	050.103.534 ⁽¹⁾
M 14 x 125	-	050.103.523 ⁽¹⁾

⁽¹⁾ Stainless steel fittings

FITTINGS BSP (GAZ) - 60 BAR

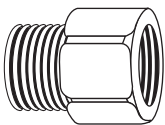

Male/Female	G 1/4" (8 x 13)	G 3/8" (12 x 17)	G 3/4" (20 x 27)
G 1/4" (8 x 13)	050.123.205	904.533.003	-
G 3/8" (12 x 17)	904.513.003	-	-
G 1/2" (15 x 21)	904.513.005	-	904.533.009
G 3/4" (20 x 27)	904.513.011	904.513.012	-
G 1" (26 x 34)	-	-	904.513.012

FITTINGS METRIC - 20 BAR

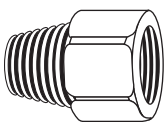

Male/Female	M 14 x 125	M 18 x 125	M 26 x 125
M 14 x 125	-	050.123.109	-
M 18 x 125	050.123.101	-	050.123.110
M 26 x 125	-	050.123.106	-

ADAPTOR METRIC TOWARDS NPS - 20 BAR

Male/Female	M 14 x 125	M 18 x 125
1/4" NPS	050.123.535	050.123.526
3/8" NPS	-	050.123.610

ADAPTOR JIC TOWARDS METRIC - 20 BAR

Male/Female	M 14 x 125	M 18 x 125
1/2" JIC	050.230.619	050.230.620

ADAPTOR JIC TOWARDS NPS AND METRIC - 20 BAR

Male/Female	1/2" JIC
1/4" NPS	050.123.304
3/8" NPS	050.123.533
M 18 x 125	050.123.521

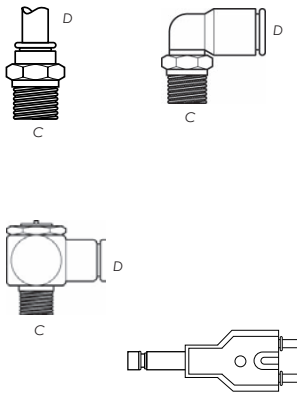

QUICK FITTINGS FOR SMALL DIAMETER SPECIAL AIR HOSES
CONFIGURATION FITTINGS

C	D	Straight	Right angle 90°	T- piece
G 1/8" (5 x 10) BSP	4	905.120.907	905.120.926	-
G 1/8" (5 x 10) BSP	8	-	905.120.934	-
G 1/4" (8 x 13) BSP	4	-	905.120.927	-
G 1/4" (8 x 13) BSP	6	905.120.965	905.120.905	-
G 1/4" (8 x 13) BSP	8	905.120.904	905.120.912	905.120.920
6 x 8 hose T	T for hose 4 x 6	2,7 x 4 Hose T- piece	4 x 6/2,7 x 4 Reduction T- piece	
905.120.915	905.120.903	905.120.957	905.120.928	

ISO 6150 QUICK-FIT FITTINGS (MAXIMUM PRESSURE: 10 BAR)

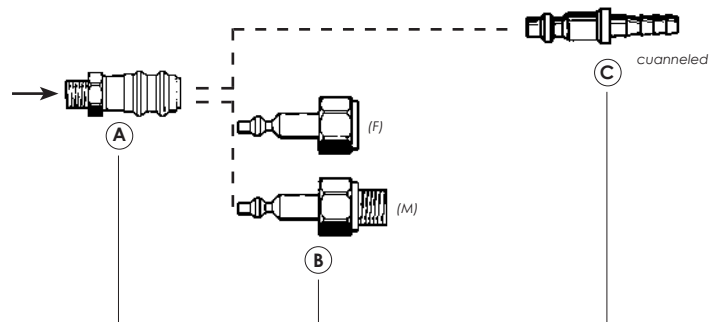

QUICK FITTINGS

Type	Complete assembly A and B	Part A with built-in chutter valve	Part B	Part C for rubber hose Ø 7	Part C for rubber hose Ø 10
Ø5 (14x125)	905.030.405	905.030.102	905.030.406 (F)	905.030.203	905.030.204
Ø5 (1/4" BSP)	-	-	905.030.804 (M)	-	-
Ø5 (1/4" BSP)	-	-	905.030.803 (F)	-	-
Ø5 (1/4" NPS)	905.030.105	905.030.104	905.030.106 (F)	-	-
Holding collar	-	-	-	906.311.224	906.311.226

COMPLETE QUICK DISCONNECT 1/4" NPS FOR AIR HOSE

Description	Part number
Air inlet quick-disconnect fitting	905.030.105

QUICK FITTINGS FOR Ø 8 HOSE

Type	Part A with on/off press button for hose Ø 8	Part C for hose Ø 8
Ø 5	905.030.801	905.030.802

FITTINGS FOR LOW PRESSURE POLYAMIDE HOSES

FITTINGS CONFIGURATION

Thread size	Material	Hoses Inter. Diameter (mm)	Part number
M 3/8" NPS	Nickel plated brass	6.35 - 1/4	050.231.350
M 1/4" NPS	Nickel plated brass	6.35 - 1/4	050.231.450
M 3/8" NPS	Nickel plated brass	9.52 - 3/8	905.140.103

CRIMP FITTINGS FOR LOW PRESSURE AIR HOSES
FITTINGS CONFIGURATION



Material	Thread size	Hoses Inter. Diameter (mm)	Part number	Collar
Straight fittings				
Nickel plated brass	1/4" NPS	7	050.231.705	906.311.224
Nickel plated brass	1/4" NPS	8	050.231.707	906.311.224
Nickel plated brass	1/4" NPS	10	050.231.702	906.311.226
Nickel plated brass	3/8" NPS	7	050.231.716	906.311.224
Nickel plated brass	3/8" NPS	10	050.231.706	906.311.226
Nickel plated brass	3/8" NPS	16	050.231.701	906.311.232
Stainless steel	M 14 x 125	5	050.230.610	906.311.208
Nickel plated brass	M 14 x 125	10	050.230.602	906.311.226
Nickel plated brass	M 18 x 125	7	050.230.616	906.311.224
Stainless steel	M 18 x 125	10	050.230.614	906.311.226
Nickel plated brass	M 18 x 125	10	050.230.606	906.311.226
Nickel plated brass	M 18 x 125	16	050.230.601	906.311.232
Nickel plated brass	M 26 x 125	16	050.230.603	906.311.232
Elbow fittings				
Nickel plated brass	M 18 x 125	10	050.250.202	906.311.226
Junction fittings without thread				
Nickel plated brass	-	7	050.190.403	906.311.224
Nickel plated brass	-	10	050.190.401	906.311.226

PLUGS PMAX: 20 - 60 BAR
PLUGS CONFIGURATION

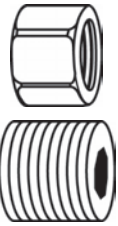

Description	Part number
Male	Male
G 1/8" (5 x 10)	906.333.106
G 1/4" (8 x 13)	906.333.102
G 3/8" (12 x 17)	906.333.104
G 1/2" (15 x 21)	906.333.103
G 3/4" (20 x 27)	906.333.105

MALE TO MALE FITTINGS (PROTECTIVE COATED STEEL) PMAX: 400 BAR
FITTINGS CONFIGURATION



Male/Male	1/2" JIC	3/4" JIC	7/8" JIC
1/2" JIC	050.102.301	905.160.201	550.914
3/4" JIC	905.160.201	905.160.202 - - 550.545	550.915
7/8" JIC	550.914	550.915	-

MALE TO FEMALE FITTINGS (STAINLESS STEEL) PMAX: 360 BAR
FITTINGS CONFIGURATION



Male/Female	1/2" JIC
3/4" JIC	050.123.301

**MALE TO MALE ADAPTERS: PMAX: 360 BAR
PROTECTED STEEL FITTINGS CONFIGURATION**



Male/Male	1/2" JIC	3/4" JIC
1/4" NPT	000.972.025	905.160.212
3/8" NPT	000.972.028	905.160.206
1/2" NPT	-	905.160.204
3/4" NPT	-	905.160.203

STAINLESS STEEL FITTINGS CONFIGURATION

Male/Male	1/2" JIC	3/4" JIC
1/8" NPT	905.210.501	-
1/4" NPT	905.210.502	905.210.512
3/8" NPT	905.210.503	905.210.513
1/2" NPT	905.210.504	905.210.514
3/4" NPT	-	905.210.515

PROTECTED STEEL FITTING CONFIGURATION

Male/Male	1/2" JIC	3/4" JIC	7/16" JIC	7/8" JIC	1 1/16" JIC	1 5/16" JIC
1/8" G co	550.548	-	550.920	-	-	-
1/4" G co	550.542	-	-	-	-	-
3/8" G co	550.549	550.679	-	550.609	-	-
1/2" G co	-	550.544	-	550.540	550.903	-
3/4" G co	550.905	-	-	550.823	550.864	550.932
1" G co	-	-	-	-	550.900	550.901

NICKEL-COATED FITTINGS CONFIGURATION

Male/Male	1/2" JIC	3/4" JIC
3/8" NPT	050.470.202	905.160.103

**MALE TO FEMALE ELBOW FITTINGS
PMAX: 360 BAR
FITTINGS CONFIGURATION**



Male/Female (free nut)	1/2" JIC
1/2" JIC	905.160.101

**MALE TO MALE ELBOW FITTINGS (STAINLESS STEEL)
PMAX: 360 BAR
FITTINGS CONFIGURATION**



Male/Male	1/2" JIC	3/4" JIC
1/4" NPT	905.210.602	905.210.612
3/8" NPT	905.210.603	-
1/2" NPT	905.210.604	-
3/4" NPT	-	905.210.615

**MALE TO MALE ELBOW FITTINGS (PROTECTIVE COATED STEEL)
PMAX: 360 BAR
NPT FITTINGS CONFIGURATION**

Male/Male	1/2" JIC	3/4" JIC
1/8" NPT	905.160.105	-
1/4" NPT	-	905.160.102

G CO FITTING CONFIGURATION

Male/Male	1/2" JIC	3/4" JIC
1/4" G co	550.596	550.923
3/8" G co	551.819	-

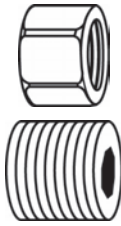

PLUGS PMAX: 360 BAR
PLUGS CONFIGURATION

Description	Part number
Female 1/2" JIC	906.333.301
Male 1/8" NPT	906.333.108

LOW PRESSURE VALVES
3 WAYS VALVE PART NUMBERS

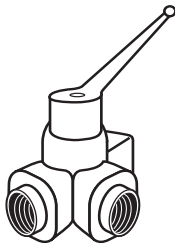

Description	Part number
3 x 1/4" BSP (female)	903.090.804
3 x 1/4" BSP (female) (stainless steel)	903.090.805

2 WAYS MALE/MALE VALVE PART NUMBERS

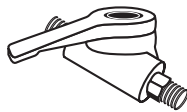

Description	Input	Output	Part number
Ball valve	(M) G 1/4" (8 x 13)	(M) M 14 x 125	050.070.205
Inlet (male) G 3/8" (12 x 17) outlet (male) M 14 x 125	(M) G 3/8" (12 x 17)	(M) M 1/4" NPS	050.070.211
Inlet (male) G 1/2" (15 x 21) outlet (male) M 18 x 125	(M) G 1/2" (15 x 21)	(M) M 18 x 125	050.070.204
Inlet (male) G 1/2" (15 x 21) outlet (male) de0101G 1/2 (15 x 21)	(M) G 1/2" (15 x 21)	(M) M 18 x 125	050.070.201
Inlet (male) G 3/8" (12 x 17) outlet (male) M 18 x 125	(M) G 3/8" (12 x 17)	(M) M 18 x 125	050.070.212

2 WAYS FEMALE/FEMALE VALVE PART NUMBERS

Description	Input	Output	Part number
Valve	(F) 1/4" BSP (8 x 13)	(F) 1/4" BSP (8 x 13)	903.090.806
Valve	(F) 3/8" BSP (12 x 17)	(F) 3/8" BSP (12 x 17)	903.090.206

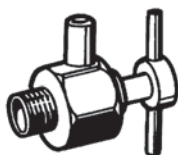

AIR BLEEDING VALVES
AIR BLEDDING VALVE PART NUMBER

Description	Part number
Inlet thread (male) G 1/4" (8 x 13)	903.093.302



NEEDLE VALVES
2 WAYS VALVE PART NUMBERS

Description	Input	Output	Part number
Female/Male	M 14 x 125	M 14 x 125	050.070.179
Male/Male	G 1/4" (8 x 13)	M 14 x 125	050.070.101

3 WAYS VALVE PART NUMBERS

Description	Part number
Female/male/male M 14 x 125	050.070.401



HIGH PRESSURE FLUID VALVES

PART NUMBER

Description	Input	Output	Maximum fluid pressure (bar)	Part number
Female/Female	G 3/8" (12 x 17)	G 3/8" (12 x 17)	250 bar	000.750.040

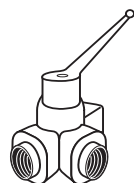

3 WAYS VALVE - 350 BAR - PART NUMBERS

Description	Part number
3 x 1/4" BSP (female) (stainless steel)	903.091.006

AIR LINE OUTPUT CONTROL VALVES

VALVE PART NUMBERS



Description	Input	Output	Part number
Female/Male	G 1/4" (8 x 13)	G 1/8" (8 x 13)	050.070.190
Female/Male	M 14 x 125	M 14 x 125	050.070.179

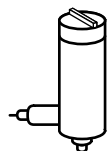

BLEEDING VALVES

BLEEDING VALVES PART NUMBERS

Description	Input	Output	Maximum fluid pressure (bar)	Part number
Male/Male	G 1/4" (8 x 13)	M 18 x 125	400	000.760.000

FITTINGS - GENERAL INFORMATION

DETAILS

Denomination	Fitting characteristics	Geographical area	Max. operating pressure (bar)
M	cylindrical metric	France	20
G = BSP	conical gas (or cylindrical)	Europe - Asia	60
NPT	conical	USA - Asia	60
NPS	cylindrical	USA - Asia	60
JIC	cylindrical angle 74°	Universal	360



REGULATORS

1/4" (with grey or red knob) , 1/2" and 3/4" (with red ring) regulators are used on the compressed air lines.

CHARACTERISTICS

Regulator	1/4"	1/2"	3/4"
Max. inlet pressure (bar)	9	20	21
Max. output (m ³ /h)	25	210	360

CONFIGURATION

Description	Pressure (bar)	Type	Part number
Red knob regulator	3,5	1/4"	016.240.000
Grey knob regulator	3,5	1/4"	016.380.000
2 regulators 1/4" with isolating valves 2 manometers, 1 inlet valve - 1 outlet valve M 1/4" NPS	3,5 & 9	1/4"	019.400.000
Grey knob regulator	5,5	1/4"	016.390.000
Red knob regulator	5,5	1/4"	016.370.000
Regulator with pressure gauge inlet fitting 1/4" - outlet fitting M1/4" NPS	5,5	1/4"	019.720.000
Grey knob regulator	9	1/4"	016.360.000
Phosphor knob regulator	9	1/4"	016.365.500
Bare regulator	4	1/2"	016.200.000
Bare regulator	9	1/2"	016.280.000
Equipped regulator with pressure gauge and wall bracket	10	1/2"	019.780.100
2 regulators (1/4" + 1/2") with isolating valves 2 manometers, 1 inlet valve - 2 outlet valves M 1/4" NPS	9	1/4"	019.390.000
Red ring regulator	10	1/2"	016.470.000
Red ring regulator	10	3/4"	016.480.000
Wall bracket	-		016.180.010

DE 37 PURIFIER-REGULATOR WITH FILTER CARTRIDGES

Usually fitted in the paint spray booths. Its twin-body construction ensures completely water and oil free.

Technical characteristics:

- Maximum operating air output: 37 m³/h
- Maximum operating air pressure: 10 bar
- Height: 290 mm
- Air inlet opening: F1/4"G

Standard equipment:

- One regulated pressure gauge
- One F1/4"G
- One tap valve F1/4"G
- Two air outlet taps: M 1/4" NPS



SPECIFICATIONS

Air output (m ³ /h)	37
Maximum fluid pressure (bar)	10
Height (cm)	29
Fitting	Air Inlet F8 x 13G
Set-up	1 regulated pressure gauge 1 valve F 1/4" G 1 ball valve F 1/4" G 2 air outlet taps M 1/4" NPS

PART NUMBERS

Description	Part number
Purifier with DE 37 regulator	015.240.000
Blue cartridge for water	015.230.500
Red cartridge for oil	015.230.200

REGULATORS, FILTERS AND LUBRICATORS

Regulators with pressure gauges, filters and lubricators with polycarbon reservoirs are all modular, allowing you to put together the best air treatment equipment for your needs.



Part 1

- Filter with trunnion deflector, transparent polycarbon reservoirs (heat resistant up to 50°C), manual bleed and a bronze filter capable of holding all particles larger than 5 microns.
- Regulator with pressure gauge: self-regulating and vibration free, pressure gauges from 0 to 12 bar/180 psi, equipped with automatic decompression system
- Lubricator with transparent polycarbon lid (heat resistant up to 50°C), flush adjustment screw; it lubricates by fine vaporisation
- Maximum operating pressure: 12 bar/180 psi

REGULATORS, FILTERS, LUBRICATORS CONFIGURATION (PART 1)

Type	Inlet diameter	Outlet diameter	Output at 9 bar (l/mn)	Part number
Regulator with gauge				
M 150/2	1/4"	1/4"	1000	004.601.100
M 250/3	1/2"	1/2"	5250	004.601.300
Filter with polycarbonate tank				
M 100/2	1/4"	1/4"	1760	004.603.100
M 200/2	3/8"	3/8"	7000	004.603.200
Lubricator with polycarbonate tank				
M 110/2	1/4"	1/4"	2500	004.604.100
M 210/3	1/2"	1/2"	5250	004.604.300

REGULATORS, FILTERS, LUBRICATORS CONFIGURATION (PART 2)

Type	Inlet diameter	Outlet diameter	Part number
Bare 3/4" regulator	3/4" G	3/4" G	91.530
Bare 3/4" regulator + filter	3/4" G	3/4" G	91.532
3/4" regulator with manometer Ø 62 mm	3/4" G	3/4" G	91.531
3/4" regulator with manometer Ø 62 mm + filter	3/4" G	3/4" G	91.533
Filter 3/4" regulator	3/4" G	3/4" G	91.534
3/4" regulator, filter, lubricator, adjusting valve on wall base	1/2" G	1/2" G	91.398
Bare 1/4" regulator	1/4" G	1/4" G	91.551
Bare 1/4" regulator + filter	1/4" G	1/4" G	91.555
1/4" regulator with manometer Ø 62 mm	1/4" G	1/4" G	91.552
1/4" regulator with manometer Ø 62 mm + filter	1/4" G	1/4" G	91.558
Bare 1/4" filter	1/4" G	1/4" G	91.553
Ø 62 mm manometer side output - 0 to 10 bar	1/8" G	-	151.080.094
Ø 62 mm manometer rear output - 0 to 10 bar	1/8" G	-	151.080.091
Wall bracket for 3/4" regulators	-	-	210.006
Reatining ring for regulator (mounting on control panel)	-	-	91.540
Locking mechanism for regulators	-	-	91.545
Adjusting valve with lock	-	-	91.544
Lubrication oil (2 liters)	-	-	149.990.017



Part 2



ACCESSORIES

Allow the easy assembly and fitting of regulators, lubricators and filters to provide the ideal system.

PART NUMBERS

Description	Part number
Regulator support bracket F 171/1 for 1/8" and 1/4"	004.601.002
Regulator support bracket F 176/1 for 3/8" and 1/2"	004.601.201



PRESSURE GAUGES

Built to last in metal with glass lenses, they are completely impact and solvent resistant.

CONFIGURATION

Description	Internal diameter (mm)	Pressure range (bar)	Part number
Pressure gauge - central inlet	40	0 - 6	910.011.205
Pressure gauge - central inlet	40	0 - 2,5	910.011.208
Pressure gauge - central inlet	50	0 - 6	910.011.403
Pressure gauge - side inlet	50	0 - 10	910.011.402
Pressure gauge - side inlet	50	0 - 4	910.011.404

PRACTICAL PAGES

CHOOSING A PUMP

To optimize

- For the best pump capacity, first work out the output you are going to require. This will include the sprayguns themselves, and any circulation you plan to have within this system. Once you have this figure, multiply by 1.2, and then choose the pump of which output at 30 cycles per minute is the nearest.
- The compression ratio you will need is defined by the pressure losses due to the length and diameter of the hosing of your system. To calculate these pressure losses, see page 99.

Example

let say you want to feed 3 conventional guns with an output of 500 cc/mn each, plus a circulation of 0,5 l/mn.

The total output will thus be 2 l/mn. The optimal pump capacity would be: $(2\ 000 \times 1,2) \div 30 = 80$ cc/cycle.

The best-suited pumps will be:

- » the PMP 150 (output of 100 cc/cycle and pressure ratio of 1:1) for low viscosity materials and a small circulating (pressure loss < 3 bar).
- » the 02.75 (output of 85 cc/cycle and pressure ratio of 2:1) for thicker materials and a normal circulating (pressure loss < 6 bar).
- » the 04.120 (output of 240 cc/cycle and pressure ratio 4:1) for large pressure loss in circulating (up to 15 bar).

PUMP MATERIAL FEEDING

To guarantee the right delivery of product, we offer the following range of equipment for various product viscosity:

- » 0 - 300 cps
 - suction rod.
- » 300 to 8 000 cps
 - top outlet pressure pots,
 - pumps (gravity or suction rod),
 - pump with base intake valve.
- » 8 000 to 15 000 cps
 - bottom outlet pressure pots,
 - pumps with suction rods,
 - compressor.
- » 15 000 to 30 000 cps
 - no more pressure pot,
 - no more suction rod,
 - submerged hydraulic pump,
 - compressor,
 - pump with single action elevator.
- » 30 000 à 1 000 000 cps and +
 - pumps with peak feeder and double action elevator.

PRACTICAL PAGES

FILTRATION EQUIVALENCE

Mesh (number of holes in 25,4 mm)	Micron	N° filtre (mesh opening in µm)
10	1480	–
16	975	–
20	750	30
25	630	25
30	500	20
40	375	–
45	360	15
50	300	12
60	238	–
70	210	8
80	175	6
100	149	–
140	100	4
170	90	3
200	74	–
250	60	–
270	50	2
325	40	1
400	35	–

PRESSURE LOSS IN FLUID HOSES

Pressure drop is the resistance that prevents material from moving forward in the pipe. Two pipe variables influence this resistance: the (inside/internal) diameter and the pipe length. The pump will generate a pressure, strong enough to move the fluid material through the pipe (or hose) to the material pipe outlet. This pressure must be enough to overcome the original pressure drop. While it is hard to reduce the pipe length, it is relatively easy to select an appropriate internal pipe diameter.

PRESSURE DROP CALCULATION

$$\text{Pressure loss (bar/m)} = \frac{6.9 \times \text{Flow (l/min)} \times \text{Viscosity (cps)}}{D^4 \text{ (int dia in mm)}}$$

$$\text{Pressure loss (psi/Ft)} = \frac{2.73 \times \text{Flow (gpm)} \times \text{Viscosity (cps)}}{D^4 \text{ (int dia in inches)}}$$

FLOW RATE CALCULATION

$$\text{Flow (l/min)} = \frac{\text{Pressure loss (bar/m)} \times D^4 \text{ (int dia in mm)}}{6.9 \times \text{Viscosity (cps)}}$$

$$\text{Flow (gpm)} = \frac{\text{Pressure loss (psi/Ft)} \times D^4 \text{ (int dia in inches)}}{2.73 \times \text{Viscosity (cps)}}$$

PIPE DIAMETER CALCULATION

$$\text{Interior Dia (mm)} = \sqrt[4]{\frac{6.9 \times \text{Flow (l/min)} \times \text{Viscosity (cps)}}{\text{Pressure Loss (bar/m)}}}$$

$$\text{Interior Dia (in)} = \sqrt[4]{\frac{2.73 \times \text{Flow (gpm)} \times \text{Viscosity (cps)}}{\text{Pressure loss (psi/Ft)}}}$$

PRACTICAL PAGES

PRESSURE LOSS IN AIR HOSES

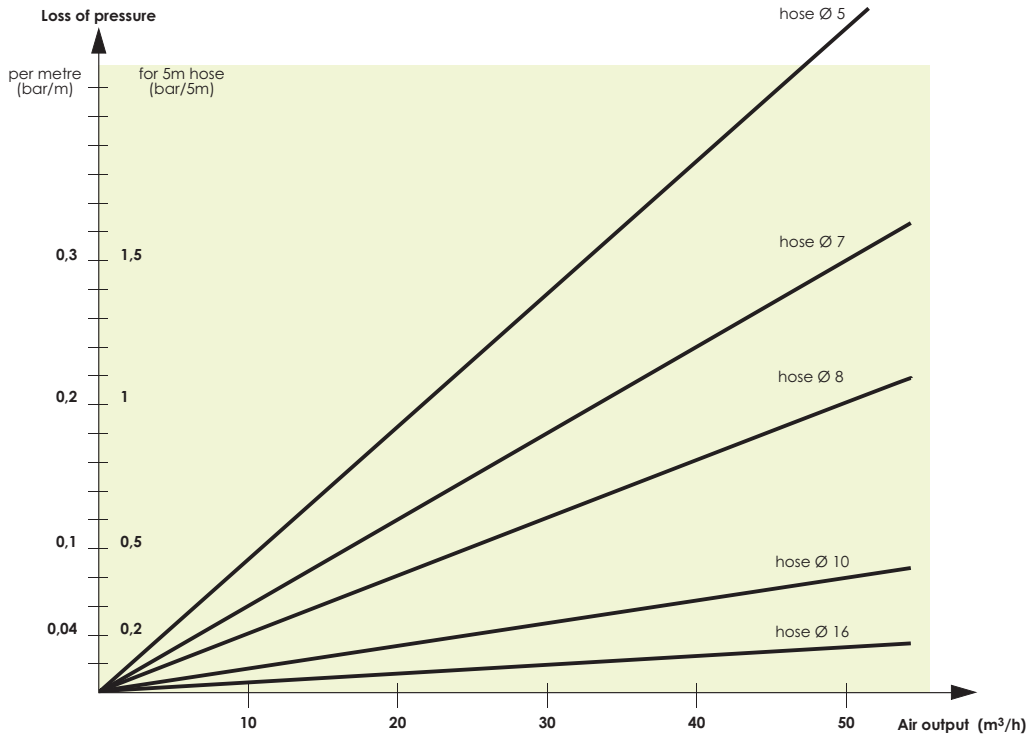

ELECTROSTATIC SPRAYING : SUITABILITY OF THE EQUIPMENT DEPENDING ON THE RESISTIVITY OF THE PAINTS

- The wrap-around affect is optimized with paints of resistivity range of 5 - 50 MΩ.cm..
- Specific hoses allows for wrap-around effects for resistivity range higher than 2MΩcm.
- For water-based materials (0 MΩ.cm), a special ISObubble enclosure allows to benefit from all the advantages of electrostatic spraying in complete safety.

LIST SHOWING THE COMPRESSED AIR CONSUMPTION OF NORMAL AIR TOOLS

We generally multiply the instant consumption by a coefficient of 0,5 to 0,9 to allow for the time the tool is not in use.

The average air volume delivered by a compressor of 1 CV is of 8 m³/h.

Tool	Consumption	
	l/mn	m³/h
Projection equipment	800 at 1 800	48 at 108
Riveter	450 at 1 500	27 at 90
Pneumatic drill	600 at 1 200	36 at 72
Linisher Ø 230	1 200 at 4 000	72 at 240
Drill 13 mm	600	36
Rotating sander	200 at 400	12 at 24

Tool	Consumption	
	l/mn	m³/h
Conventional gun	160 at 500	10 at 30
AIRMIX® gun	67 at 134	4 at 8
Pumps	160 at 1 350	10 at 80
Blower	200 at 400	12 at 24
Screwdriver	200 at 400	12 at 24

Calculate exactly the maximum air consumption of pump in l/mn : Q

The formula is :

$$Q = 1.2 \times \text{fluid output} \times \text{pressure ratio} \times (\text{air motor feeding pressure in bar} + 1 \text{ bar for atmosphere})$$

Example for a pump 16.120 : $Q = 1.2 \times 4,8 \times 16 \times (6 + 1) = 645.12 \text{ l/mn}$ or $(645.12 \times 60) : 1000 = 38.7 \text{ m}^3/\text{h}$

PRACTICAL PAGES

VALUE OF « PH »

The pH value of a liquid or a solution quantifies its concentration of hydrogen ions and tells us the extent to which it is acidic or alkaline. The PH value dictates the best materials to be used in construction of major paint handling and spraying equipment.

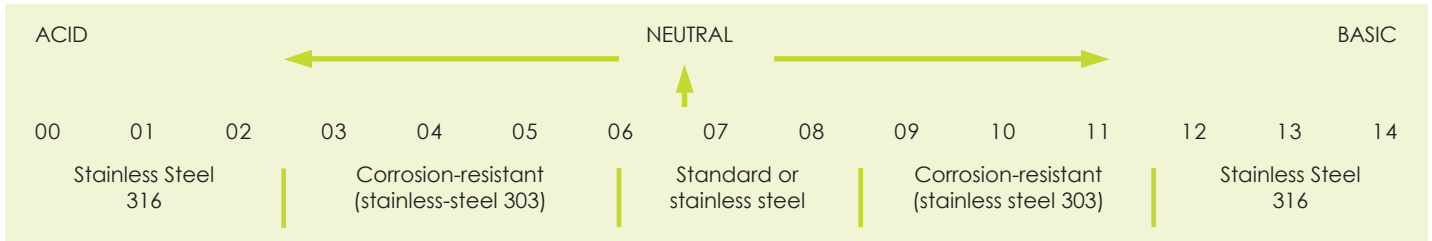

PRACTICAL INFORMATION: METRIC - ENGLISH CONVERSION

CONVERT FROM	TO	MULTIPLY BY
Centimeters	feet	0.03280
Centimeters	inches	0.3937
Centimeters/min.	feet/min.	1.9684
Centimeters/sec.	feet/sec.	0.03281
Cubic centimeters.	cubic feet	3.5314 x 10 ⁻⁵

CONVERT FROM	TO	MULTIPLY BY
Cubic centimeters	ounces	0.033
Cubic centimeters	liquid gallons	0.0002642
Cubic feet	liquid gallons	7.4805
Cubic feet	cubic inches	1.728
Cubic feet/min.	gallons/min.	7.4805

CONVERT FROM	TO	MULTIPLY BY
Cubic inches	gallons	0.004329
Cubic inches	cubic centimeters	16.387
Cubic inches	cubic feet	0.0005787
Cubic meters	liquid U.S. gallons	264.17
Cubic meters	cubic centimeters	1 x 10 ⁶

CONVERT FROM	TO	MULTIPLY BY
Cubic meters	cubic feet	35.31
Cubic meters	cubic inches	61,023.38
Feet	centimeters	30.48006
Feet	meters	0.3048006
Feet of water	atmosphère	0.02949

CONVERT FROM	TO	MULTIPLY BY
Feet of water	psi	0.443
Feet/hour	miles/hour	0.00018933
Feet/min.	meters/min.	0.3048
Feet/min.	miles/hour	0.01136
Feet/sec.	miles/hour	0.681818

CONVERT FROM	TO	MULTIPLY BY
Gallons	cubic cm	3 785,43
Gallons	cubic inches	231
Gallons	imperial gallons	0,83268
Gallons	cubic feet	0,13368
Gallons/min.	cubic feet/min.	0,13368

CONVERT FROM	TO	MULTIPLY BY
Inches	feet	0,083333
Inches	meters	0,254
Inches	millimeters	25,40005
Inches	mils	1 000
Kilograms	pounds	2,2046

CONVERT FROM	TO	MULTIPLY BY
Kilogrammes/cm ²	psi	14,2233
Kilogrammes/mm ²	psi	1 422,33
Liters	gallons	0,264178
Meters	feet	3,2808
Meters	inches	39,37

CONVERT FROM	TO	MULTIPLY BY
Poise	centipoise	100,0
Pints of water	gallons	0,11985
PSI	atmosphère (bar)	0,06804
Inches ²	cm ²	6,4516
Inches ²	feet ²	0,006944
Inches ²	mm ²	645,163
Millimètres ²	inches ²	0,0015499
daN	Kilograms	1.0

- » For the diameter of a circle, multiply the circumference by 0.31831.
- » For the circumference of a circle, multiply the diameter by 3.1416.
- » For the surface of a circle, multiply the diameter² by 0.7854.
- » For the surface of a sphere, multiply the diameter² by 3.1416.
- » To find the side of a square that has the same surface area of a circle, multiply the diameter by 0.8862.
- » To find the number of cubic inches in a sphere, multiply the diameter by 0.5236.
- » To find the number of gallons inside a pipe or cylinder, divide the volume in liters by 231.
- » To find the cubic volume of a cylinder or pipe, multiply the section area by the length.

PRACTICAL INFORMATION

CHEMICAL COMPATIBILITY CHARTS

MATERIAL IN CONTACT (WETTED PARTS)

	Carbon steel	Aluminium	Brass	Stainless steel	Nylon	Nitrile	Vitton	Leather	P.U.
Butyl acetate	👍👍👍	👍👍👍	👍👍👍	👍👍👍	👍👍👍	N	N		N
Ethyl acetate	👍👍	👍👍	👍👍	👍👍	👍👍👍	N			
Acetaldehyde	👍👍👍	👍👍👍	👍👍👍	👍👍👍	👍👍👍	N	N	👍👍	N
Amonium acetate				👍👍👍					
Acedic acid	👍👍👍			👍👍👍	👍👍👍	N	N	N	N
Boric acid	👍👍👍	👍👍👍		👍👍👍	👍👍👍		👍👍👍	👍👍👍	👍👍👍
Hydrobromic acid					👍👍👍	N	👍👍👍		
Chloridic acid	N	N		N	👍👍👍	N	👍👍👍		
Chromic acid	N	N	N	👍	👍👍👍	N			
Citric acid				👍👍👍	👍👍👍		👍👍👍		
Fluorohydric acid						N	👍👍👍		
Fluosilicic acid			👍👍👍		👍👍👍	N	N		
Formic acid	N	👍👍	N	👍	👍👍👍	N	👍		
Nitric acid	N	N	N	👍👍👍	👍👍👍	N	👍👍👍		
Oxylic acid	N	N	N	N	👍👍👍		👍👍👍	👍👍👍	👍👍👍
Phosphoric acid	N	N		👍👍👍	👍👍👍	N	👍👍👍		
Ethylalcohol						👍👍👍	N		
Methylalcohol	👍👍👍						N	👍👍👍	N
Acetic aldehyde	👍👍👍	👍👍👍		👍👍👍	👍👍👍	N	N		N
Formic aldehyde	N	👍👍	N	N	👍👍👍	N	👍👍👍		N
Sodium alginate					👍👍👍		N		
Starch						👍👍👍	👍👍👍		
Amines					👍👍👍	N	N	N	
Acetone	👍👍👍	👍👍👍		👍👍	👍👍👍	N	N		N
Liquid ammonia	👍👍👍	👍👍👍		👍👍👍	👍👍	👍👍	N	N	
Benzene	👍👍👍	👍👍👍	👍👍👍	👍👍👍	👍👍👍	N	👍👍👍	👍👍	👍
Sodium bicarbonate		N	N	👍👍👍	👍👍👍	👍👍👍	👍👍👍		
Chlorine dioxide						N	👍👍👍		
Sodium bisulphate	N	N		N	👍👍👍	N	👍👍👍		
Brominate						N			
Calcium carbonate	👍👍👍			👍👍👍	👍👍👍	👍👍👍	👍👍👍	👍👍👍	
Sodium carbonate					👍👍👍		👍👍👍		
Chlorinate, gas						👍👍👍	👍👍👍		
Sodium chlorite							👍👍👍		👍👍👍
Aluminum chlorosulfate					👍👍👍	👍👍👍	👍👍👍	👍👍👍	
Calcium chloride	👍👍👍			👍👍👍	👍👍👍		👍👍👍		👍👍👍
Magnesium chloride	👍👍	N		N	👍👍👍	👍👍👍	👍👍👍	👍👍👍	👍👍👍
Potassium chloride	N	N		👍👍	👍👍👍	👍👍👍	👍👍👍	👍👍👍	👍👍👍
Sodium chloride					👍👍👍	👍👍👍	👍👍👍		👍👍👍
Zinc chloride	N	N		N	👍👍👍	👍👍👍	👍👍👍		👍👍👍
Ferrous chloride	N	N	N	N	👍👍👍		👍👍👍		
Ferric chloride	N	N	N	N	👍👍👍		👍👍👍		👍👍👍
Cyclohexane	👍👍👍	👍👍👍	👍👍👍	👍👍👍	👍👍👍	👍👍👍	👍👍👍		
Chlorobenzene	👍👍👍			👍👍👍	👍	N	👍👍👍		N
Ethylene chloride		👍👍			👍👍	N	👍👍		N
Methylene chloride	👍👍	N	👍👍	👍👍	N	N	👍👍		N
Diatoms						👍👍👍	👍👍👍		
Dichloroethylene					👍👍👍				
Diethylene glycol	👍👍👍	👍👍		👍👍👍	👍👍👍	👍👍👍	👍👍👍		N
Bleach	N	👍👍		👍👍👍	👍👍👍				👍
Distilled water	N	👍👍👍	👍👍👍	👍👍👍	👍👍👍		👍👍👍	👍👍👍	👍👍👍
Oxygenated water	N		N	👍👍	N		👍👍		👍👍👍
EDTA						👍👍👍	N		

PRACTICAL INFORMATION

CHEMICAL COMPATIBILITY CHARTS

MATERIAL IN CONTACT (WETTED PARTS)

	Carbon steel	Aluminium	Brass	Stainless steel	Nylon	Nitrile	Vitton	Leather	P.U.
Fertilizer						👍👍👍	N		
Ethanol					👍👍👍	👍👍👍	N		
Ethyl ether	👍👍	👍👍		👍👍	👍👍👍	N	N		👍
Ethylene glycol	👍👍	👍👍	👍👍👍	👍👍	👍👍👍	👍👍👍	👍👍👍		N
Ethyl-mercaptan						N	👍👍👍		
Fuel						N	👍👍👍		
Fluosilicate			👍👍👍		👍👍👍	👍👍👍	👍👍👍		
Formaldehyde	N	👍👍		N	👍👍	👍👍👍	👍👍👍		N
Glycol	👍👍	👍👍		👍👍	👍👍👍	👍👍👍	👍👍👍		N
Gelatine	N	👍👍		👍👍👍	👍👍👍	N	N		N
Sodium hydroxide					👍👍👍	N	N		N
Ammonium hydroxide				👍👍👍	👍👍👍	N	N	👍👍	N
Potassium hydroxide	👍	N		👍👍	👍👍👍	N	N		N
Calcium hypochlorite				👍	👍👍👍	N	👍👍👍	N	
Sodium hypochlorite					👍👍👍	N	👍👍👍		N
Sodium hyposulfite					👍👍👍	N	👍👍👍		
Fruit juice						👍👍👍	👍👍👍		
Methanol	N	👍👍👍		👍👍👍			N		👍
Morpholine	👍👍👍	👍👍👍				N	N		
Methylethylcetone	👍👍👍	👍👍		👍👍👍	👍👍👍	N	N		N
Sodium nitrite					N	N	👍👍👍		
Perchloroethylene (tetrachloret.)	👍👍👍	👍👍		👍👍👍	N	👍👍	👍👍👍		N
Permanganate de potassium	👍👍	👍👍		👍👍	👍👍👍	N	👍👍👍		
Hydrogen peroxide	N	👍👍👍	N	👍👍		N	👍👍		
Chlorohated Peroxyde						N	👍👍👍		
Phenol	N	N			👍👍👍	N	👍👍👍		
Ammonium phosphate			👍👍👍	👍👍👍	👍👍👍	👍👍👍	👍👍👍		
Trisodium phosphate	👍👍👍	N		👍👍👍	👍👍👍	👍👍👍	👍👍👍		
Aluminium polychlorite						👍👍👍	👍👍👍		
Polyelectrolytes						👍👍👍	👍👍👍		
Caustic potash		N		👍👍👍		N	👍👍👍		
Sodium silicate					👍👍👍	👍👍👍	👍👍👍		
Soda						N	N		
Aluminium sulfate					👍👍👍	👍👍👍	👍👍👍	👍👍👍	N
Ammonium sulfate					👍👍👍	👍👍👍	👍👍👍		👍👍👍
Calcium sulfate	👍👍👍	👍👍👍		👍👍👍	👍👍👍		👍👍👍		
Copper sulfate				👍👍👍	👍👍👍	👍👍👍	👍👍👍		👍👍👍
Ferrous sulfate		N		👍👍	👍👍👍	👍👍👍	👍👍👍		
Ferric sulfate	N	N		N	👍👍👍	👍👍👍	👍👍👍		👍👍👍
Sodium sulfate	N				👍👍👍	👍👍👍	👍👍👍		
Hydrogen sulfur	👍👍👍				👍👍👍	👍👍👍	N		
Carbon tetrachloride	👍👍		👍👍👍	👍👍👍	👍👍👍	N	👍👍👍		
Toluene	👍👍👍	👍👍👍		👍👍👍	N	N	👍👍👍		N
Trichlorethane	👍👍	N		👍👍	N	N	👍👍👍		N
Trichlorethylene	👍👍	👍👍👍		👍👍	N	N			N
Triethyleneglycol				👍👍	👍👍👍		👍👍👍		
Urea	👍👍	👍👍		👍👍	👍👍👍		👍👍👍		
Xylenes	👍👍	👍👍		👍👍	👍👍👍	N	👍👍👍		N

👍👍👍 = High Compatibility
 👍👍 = Good Compatibility

👍 = Low Compatibility
 N = Not Compatible

Bond | Protect | Beautify

With our manual guns, automatic and robotic applicators, supplied by our wide range of pumps & machines for fluid handling, dosing, mixing & dispensing.

SAMES KREMLIN provides industrial solutions for production increase, quality improvement, material & cost savings.

We are designers and manufacturers of process equipment that is divided into 6 ranges:

Airspray: Since 1925, we have been an Airspray manufacturer bringing you the very best in finishing.

Airmix®: Creator of Airmix® Technology since 1975, we provide the perfect mix between quality and productivity.

Airless: We provide premium Airless Products for finishers with demanding applications.

REXSON Dispense: Pumping beyond possible, dispensing precisely.

Electrostatic liquid: expertise for high finishing quality & efficiency.

Powder: Powder coating solutions for the highest Productivity since 1960.

FIND YOUR
LOCAL CONTACT
BY FLASHCODE:



www.sames-kremlin.com

SAMES  **KREMLIN**