

SAMES KREMLIN

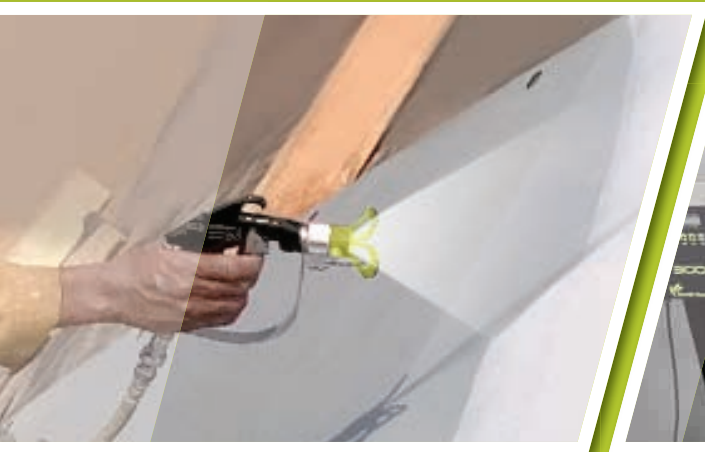

Airless spraying &
equipment



Catalog V5.1

“Premium for finishers in heavy applications”

Apply your Skills

www.sames-kremlin.com



Editor's note



In order to help you increase your competitiveness,

SAMES KREMLIN daily dedicates itself to excellence in terms of innovation and reliability.

We constantly improve our performances as well as quality to satisfy your needs.

We also help you define the equipment allowing your

installation to comply with V.O.C. directives.

We enable you to benefit from reliable technologies while ensuring you a swift return on investments.

You will find in this catalogue the equipment that will enable you to reach the paint application results you are aiming at.

Providing you with the best,

whatever your requirements, is our mission.

All SAMES KREMLIN team is at your disposal to answer your questions.

Enjoy your reading.

Table of contents

PRODUCTS RANGE

AIRLESS SPRAY GUNS	14
SFLOW™ 275 and 450 AIRLESS gun	14
AUTOMATIC AIRLESS SPRAY GUNS	20
AIRLESS AS2 Spray Gun - stainless steel	20
AIRLESS ASI 24 and 40 Spray Guns - stainless steel	22
AIRLESS ASI 40 GT and ASI 40 GTV Spray Guns - stainless steel	24
AIRLESS Guns	25
AIRLESS PUMPS	28
AIRLESS 40C50 paint pump - stainless steel	28
AIRLESS 40C50 WB paint pump - stainless steel	29
AIRLESS 40C100 paint pump - stainless steel	30
AIRLESS 40C100 WB paint pump - stainless steel	31
AIRLESS 40C260 paint pump - stainless steel	32
AIRLESS 53C120 paint pump - stainless steel	33
AIRLESS 65C260 paint pump - stainless steel	34
AIRLESS 80C220 paint pump - stainless steel	35
AIRLESS FLOWMAX® PUMPS	36
AIRLESS 34F60 FLOWMAX® paint pump - stainless steel	36
AIRLESS 40F50 FLOWMAX® paint pump - stainless steel	37
AIRLESS 40F100 FLOWMAX® paint pump - stainless steel	38
AIRLESS 40F260 FLOWMAX® paint pump - stainless steel	39
AIRLESS 65F260 FLOWMAX® paint pump - stainless steel	40
AGITATORS	44
Cyclix™ agitators for 20-40-200 l drums	44
HOSES	46
PROTECTION	48
RC 600 full visor mask	48
RC 756 respirators	49
ELECTRONIC DOSING	54
PU 3000 2l and 4l AIRLESS	54
CYCLOMIX™ Multi and Multi PH	56
CYCLOMIX™ Expert	58
FITTINGS AND AIR TREATMENT	62
PRACTICAL	72

CHAPTERS

GENERAL INFORMATION	6
AIRLESS SPRAYING	13
PLURAL COMPONENT PUMPS AND MACHINES	53
FITTINGS AND AIR TREATMENT	61

Global presence

16 Offices



CANADA
931, Progress Ave, Unit 7
SCARBOROUGH M1G 3V5
Tel.: (00) 141 643 15017
Fax: (00) 141 643 19171



UNITED STATES OF AMERICA
45001 5 Mile Rd.
PLYMOUTH, MI, 48170
Tel.: 734-979-0100
Fax: 734-927-0064

MEXICO
BERNARDO GARZA TREVINO # 1715
COL DE MAESTRO MONTERREY, N.L
CP 64180 MEXICO
Tel.: (81) 1257-1111
Fax: (81) 1352-8316



BRAZIL
Rua Alfredo Mario Pizotti, N.41
Vila Guilherme
SAO PAULO SP
Tel.: (+ 5511) 2903 1200



ARGENTINA
Avenida Juan Justo, 6021
C1416DLB CIUDAD DE BUENOS AIRES
Tel.: +54 11 45 82 89 80
Fax: +54 11 45 84 66 77



HEADQUARTERS
Sames Kremlin



GERMANY
Moselsstrasse 19
D-41464 NEUSS
Tel.: +49 213 13 69 22 00
Fax: +49 213 13 69 22 22

SAMES KREMLIN
Stains

PORTUGAL
Rua da Silveira, 554 - Tauria
2410-269 POUSOS LRA
Tel.: +351 244 848 220
Fax: +351 244 848 229



SPAIN
C/Botánica, 49
08908 L'HOSPITALET DE LLOBREGA
BARCELONA
Tel.: +34.932641540
Fax: + 34.932632829



SOUTH AFRICA
Block G, Hurlingham Office Park, Hurlingham
Johannesburg
Tel: +27 (11) 285 0040



Global presence

RUSSIA

23 Street Radionava Office 21
603093 NIZHNI NOVGOROD
Tel. : 007 831 467 8981



POLAND

Modlinska 221B
03120 - WARSZAWA
Tel. : + 48 225 10 38 50
Fax : + 48 225 10 38 77



ITALIA

Linate Business Park
Strada Provinciale Rivoltana 35
20096 Pioletto (MI)
Tel. : (+39) 02 - 48952815
Fax : (+39) 02 - 48300071



JAPAN

Takashima 2-19-12 - Sky Blig 20F
220-0003 YOKOHAMA - Nishi kanagawa
TEL: 045 412 5800
FAX: 045 412 5801
Mobile: 080 4203 3030



CHINA

Building No.9, No.3802 Shengang Road
Songjiang District
SHANGHAI 201413
Tel. : 021-5438 6060
Fax : 021-5438 6090



INDIA

GAT no - 634, PUNE NAGAR Road, Wagholi
PUNE - 412 207
Tel : +91 20 30472700/01
Fax : +91 20 30472710



SINGAPORE /SOUTH EAST ASIA

German Centre
International Business Park #05-109E
SINGAPORE 609916
Tel. : +65 65628290
Fax : +65 68359096



Office



Application Center

Paint

Decoration and protection are often two associated functions. To achieve these aims, and to re-finish products, we have at our disposal a tremendous number of surface treatments,(for example nickel or chrome plating etc.).

Paint is also perfect for both of these functions. In addition, paint is universally used, and can be applied on any surface, such as wood, metal, stone, leather, plastic and elastomers. Paint does not come as a finished product, and hence the quality of application will depend on all its stages of preparation, which we will call the "Painting System".

In general , the stages are as follows:

- » Surface preparation
- » Application of the coating (paints, stains, varnishes, etc...)
- » Drying

DISCOVER IN THE GENERAL CATALOGUE AND FOR EACH equipment, Recommended paint families, water-based or solvent-based.



WATER-BASED MATERIALS



SOLVENT-BASED MATERIALS



1. PRIMERS



2. STAINS



3. DIRECT GLOSS/METALLIC



4. TOP COATS/HIGH GLOSS



5. UV PRODUCTS



6. MOISTURE-SENSITIVE MATERIALS



7. ANTI-CORROSION - ABRASIVES

SURFACES PREPARATION

There is a wide range of physical and chemical treatments to which the surface to be coated can be subjected, before receiving the first coat.

Good surface preparation is the essential base for long-lasting protection and a good visual finish on any material.

The surface preparation is often the longest, and therefore the most important task involved in coating a part.

Material	Physical preparation	Chemical preparation
Steel:	stripping, shotblasting, brushing	acid
Aluminum:	Brushing	Vapor blast
Wood:	Sanding	
Plastic:	heating	plasma torch, acid

Once treated, the surfaces should be free from:

- » particulate or non-adherent substances
- » oil, grease and moisture

To obtain the best protection against corrosion (mainly for metal), we coat with either:

- » a wash primer or
- » an anti-corrosion paint

A **wash primer** is a liquid product of around 16s Zahn#2, which should be sprayed in a thin coat, to get into all the imperfections in the surface of the metal. The phosphoric acid which it contains attacks the surface of the metal and forms an isolating and impenetrable layer of phosphate. The wash primer is highly valued for its adhesion to the metal. Importantly, it should then be coated with a layer of paint, which plays the role of a protective shield.

An **anti-corrosion** paint is a product which should be sprayed in a thicker layer than the wash primers. Containing anti-corrosive elements, it has the advantage of protecting the metal both physically and chemically at the same time. Also, it saves time, as a single coat applies both the anti-corrosive chemicals and the protective shield to the metal.

These paints are used very frequently on metal framework, as the coating can be left as it is, or covered subsequently with the desired paint finish.



16s CA₄



40s CA₄

Paint

Looking at a painted object will tell us that paint is hard. However, the paint which we spray is a liquid.

This transformation is due in the main part to several components of paint whose functions are described below.

COMPONENTS OF PAINT

Paint contains one or more substances which are generally dissolved in a solvent (or in water) and which regain their solid consistency after drying on the surface.

Amongst these substances, we find:

- » Binders
- » Pigments
- » Fillers

The binder is generally a more or less transparent body which resembles a resin. Dissolved on its own in a solvent it produces a lacquer:

Binder + Solvent = Lacquer

Paint often bears the name of the type of solvent on which it is based (cellulose paint is based on a cellulose solvent). To darken the finish, we add highly colored and very fine powders, which we call pigments:

Binder + Solvent + Pigments = Paint

Dry and wet layer

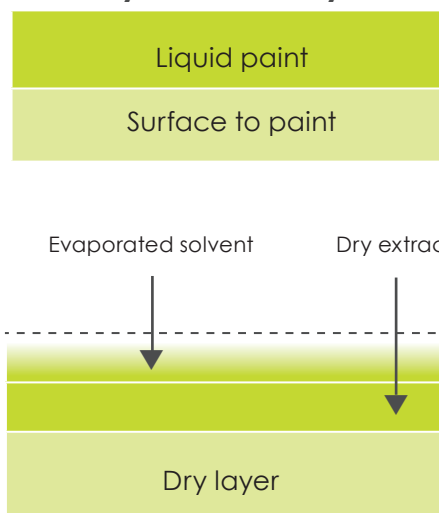

GLOSSARY

» **Sticky film:** we say that a film is sticky when we put a finger on it and it feels like adhesive tape

» **Dust-free film:** we say that the film is dust-free, when any dust which lands on it can be removed by blowing

» **Film that is dry to the touch:** we say that the film is dry to the touch when a finger does not leave a mark on the surface.

» **Finger-nail hard:** we say that the film is finger-nail hard when we cannot mark it. In this state, it can be polished or sanded.

Paint

Finally, to give the finish specific characteristics, we use a whole range of fillers and additives. Solvents make it possible to dissolve the other components of the paint, and can be classed into the following three groups:

» **Fast solvents:** they evaporate extremely quickly, to such an extent that the paint can dry too quickly, not allowing it enough time to adhere correctly to the surface.

These solvents are never used on their own.

» **Slow solvents:** they evaporate very slowly, allowing the paint to adhere properly. They leave a soft and smooth finish.

Slow solvents are not very widely used because they significantly increase the drying time.

» **Medium solvents:** they evaporate in a few seconds; this is enough to ensure good adhesion, while giving a satisfactory drying time.

In order to make the correct paint, the manufacturer first of all makes a list of the solvents capable of dissolving all the binders he wishes to include, and then chooses those with a volatility suitable for the planned method of drying (whether at room-temperature or in an oven). Before application, paint is often reduced to give a consistency which is ideal for the task.

PAINT CONSISTENCY

Viscosity

The consistency of the paint should be adapted for the type of application. It is identified by the extent of its viscosity, which is expressed in centipoises or by measuring the time in seconds that it takes for a certain amount of paint to run through a calibrated viscosity cup. There are different viscosity cups used for measuring the viscosity of paints. The table below shows the relationship between cup size and viscosities in Centipoises.

AFNOR 4 (CA4)	ISO 4	mPas.s	Centipoises	Ford 4 (CF4)	DIN 4 (D°)	CH (Fr)	ZAHN (n°2)
12	-	20	20	10	11	6	18
14	17	25	25	12	12	7	19
16	23	30	30	14	14	-	20
20	34	40	40	18	16	8	22
25	51	50	50	22	20	9	24
29	60	60	60	25	23	10	27
32	68	70	70	28	25	-	30
34	74	80	80	30	26	11	34
37	82	90	90	33	28	12	37
40	93	100	100	35	30	13	41
45	-	120	120	40	34	14	49
50	-	140	140	44	38	15	58
56	-	160	160	50	42	16	66
61	-	180	180	54	45	17	74
66	-	200	200	58	49	18	82
70	-	220	220	62	52	19	-

Nota: 1 poise = 100 centipoises and 1 mPas.s = 1 centipoise (If the density of the paint is equal as 1 and if it is a fluid Newtonien, that is to say no thixotrope).

THE EFFECT OF TEMPERATURE ON VISCOSITY

Viscosity of paint changes with variations in temperature; basically, the resins are far more fluid when they are hot.

The table below shows the changes in viscosity of a glycerophthalic paint as the temperature varies. It is worth noting that a paint which has a viscosity of 22s at 68°F will have a viscosity of 28s at 54°F and of 17s at 90°F.

		Temperatures (°C)																			
		2	4	6	8	10	12	14	16	18	20	22	24	26	28	30	32	34	36	38	40
V I S C O S I T Y I N S E C O N D S C F # 4	27	26	24	23	22	21	21	20	19	18	18	17	17	16	15	15	14	14	14	14	
	33	31	29	27	26	25	23	22	21	20	19	18	18	17	16	16	15	15	14	14	
	39	36	34	32	30	28	26	24	23	22	21	20	19	18	17	17	16	15	15	14	
	46	42	39	36	34	31	29	27	26	24	23	22	21	19	18	17	17	16	15	15	
	54	49	45	41	38	35	32	30	28	26	24	23	21	20	19	18	17	17	16	15	
	56	51	47	43	40	36	33	31	29	27	25	23	21	20	20	19	18	17	16	16	
	61	55	50	46	42	38	35	32	30	28	26	24	22	21	20	19	18	17	16	16	
	69	63	56	52	46	42	39	35	32	30	28	25	24	23	21	20	19	18	17	16	
	77	69	62	55	50	46	41	38	35	32	29	27	25	24	22	21	19	18	17	16	
	84	74	67	61	54	50	44	40	36	34	30	28	26	25	23	22	20	18	17	16	
	95	84	75	66	60	54	48	44	40	36	33	30	28	26	24	22	20	19	18	17	
	104	92	81	73	65	58	52	46	42	38	35	31	29	27	24	23	21	20	19	18	
	112	100	88	76	69	62	54	49	44	40	36	32	30	27	25	23	21	20	19	18	
	122	108	90	85	75	66	59	53	47	42	38	35	31	28	26	24	22	21	19	18	
	132	120	102	90	80	70	63	55	50	44	40	36	33	30	27	25	23	22	20	18	
	142	124	108	95	84	74	65	58	52	46	41	37	34	31	27	25	23	22	20	18	
152	132	119	101	90	80	69	61	54	48	43	38	35	31	28	26	24	23	21	18		
164	140	123	106	94	83	73	64	56	50	45	40	36	32	29	27	24	23	21	18		

Example : at a temperature de 20°C for an announced viscosity of 22 s, you should be ready for the following results:

- ▶ at 12°C, a viscosity of 28 s,
- ▶ at 32°C, a viscosity of 17 s.

Paint

Quality problems tend to arise when the temperature of the paint changes during the course of the day. For example: During the course of this day, the viscosity of the paint has moved from 23 to 17 seconds, which leads to a 22% increase in the output of the spray guns, leading to over-coloring and excessive product consumption.

	Temperatures (°C)	Viscosity - CA4 (seconds)	Spray gun output (cm ³ /mm)
morning, cool workshops	15	23	460
Later - workshop heats up	20	20	520
An oven switched on	25	17	560

Worse still, paint prepared in a hot workshop at 20 seconds can be at 28 seconds the following morning, before the workshop has got up to full working temperature: this would lead to a less fine spray and a much greater drying time.

DRYING OF PAINTS

the component of paint can be classed in two groups:

» Dry extracts

» VOC (Volatile organic compounds), or water in case of water-based paints

Drying paint is all about allowing the volatile products to evaporate and the film to harden. We must distinguish between hardening and drying.

Drying gives us the dry film purely by the evaporation of the volatile products. This happens at two stages: during spraying and within the film. Depending on the temperature, the density of the spray, the type of spray gun and the distance of the spray, the paint can arrive on the surface more or less dry. That means that the majority of the solvent has evaporated before the paint reaches the surface. The drying of the wet film is accelerated when the surface is in a well-ventilated area which has dry air and is dust-free.

NOTES

Handwriting practice lines consisting of 20 horizontal dotted lines.

AIRLESS SPRAYING

Airless spraying

Plural component pumps and machines

Fittings and air treatment

SFLOW™ 275 and 450 AIRLESS gun

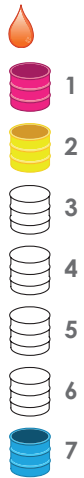

The Airless manual pressure spray gun Sflow™ allows real material savings for industrial applications with a **high transfer efficiency of 81%**. Its reliable and solid construction together with a comfortable grip and fatigue-free trigger makes that your work has never been so easy.

Sflow™ manual Airless gun optimizes efficiency and brings operator great comfort. A large choice of tips: flat, reversible Tip Top or Skill (double insert) is available for every application.

FEATURES

High end tungsten carbide tip tested individually
 Finger trigger to close the gun, tip lock, hand safety protection
 Patented dedicated tool
 Ergonomic design
 Build-in hook
 Swivel handle fitting
 Fatigue free 2 or 4 fingers
 Smart lock

BENEFITS

Reliable and repeatable spraying quality
 Enhanced security
 Quick filter change
 Comfortable grip to prevent any MDSs
 To keep the gun near the workstation
 Better maneuverability
 To fit every painter morphology
 Quick and easy tip orientation and positioning
 Increased lifetime by reducing premature wear
 Available in PA or stainless steel to prevent any tip plugging

SPECIFICATIONS

Sprayed materials	Primers, Anti-corrosion, Anti-fouling, CARC, Bitumen, Acid Catalyst, UV, Moisture sensitive, polyurethane, Solvented or Waterborne, Single or Plural-components	
Maximum fluid pressure	275 - 450	bar
Maximum fluid temperature	60	°C
Recommended material viscosity range	20>25000	cps
Weight (with swivel and tip)	597	g
Sound pressure level	88.6	dBa
Carbide seat	●	
Wetted parts: Stainless steel, Aluminum and Rulon	●	
Trigger (2 and 4 fingers)	●	
Trigger lock safety	●	
Polished forged aluminum body	●	
Fluid orifice	Ø 2.5	

FITTINGS

Fittings	Product inlet	M 1/2" JIC
Swivel fittings	Product inlet	F 1/2" JIC / M 1/2" JIC
	Product inlet	F 1/2" JIC / M 1/4" NPSM

SFLOW™ 275 and 450 AIRLESS gun

SFLOW™ AIRLESS SPRAY GUN - FOR FLAT TIPS

Type of gun	Maximum Fluid Pressure (bar)	Trigger	Flat base	Tips	Handle fluid fitting	Part number
Sflow™	275	2 fingers	●	to be ordered separately	1/2" JIC	135.740.200
Sflow™	275	4 fingers	●	to be ordered separately	1/2" JIC	135.740.400
Sflow™	275	2 fingers	●	to be ordered separately	Swivel fitting 1/4" NPSM	135.740.240
Sflow™	275	4 fingers	●	to be ordered separately	Swivel fitting 1/4" NPSM	135.740.440
Sflow™	450	4 fingers	●	to be ordered separately	1/2" JIC	135.745.420
Sflow™	450	4 fingers	●	to be ordered separately	Swivel fitting 1/4" NPSM	151.745.440

SFLOW™ AIRLESS SPRAY GUN - WITH REVERSIBLE TIP TOP TIPS

Type of gun	Maximum Fluid Pressure (bar)	Trigger	Reversible base	Tip	Handle swivel fluid fitting	Part number
Sflow™	275	2 fingers	●	TIP TOP 12-13 (515)	1/2" JIC	135.740.225
Sflow™	275	2 fingers	●	TIP TOP 12-13 (515)	1/4" NPSM	135.740.245
Sflow™	275	4 fingers	●	TIP TOP 14-13 (517)	1/2" JIC	135.740.427
Sflow™	275	4 fingers	●	TIP TOP 14-13 (517)	1/4" NPSM	135.740.447
Sflow™	450	4 fingers	●	TIP TOP 18-13 (519)	1/2" JIC	135.745.429
Sflow™	450	4 fingers	●	TIP TOP 18-13 (519)	1/4" NPSM	135.745.449

AIRLESS 30C25 PAINT PUMP WALL MOUNTED KITS WITHOUT SWIVEL FITTING SFLOW™ GUN

Kit designation	Gun type	Tip guard	Tip	Suction rod	Hoses * Length (m)	Pump output filter	Part number
Wall-mounted with SFLOW™ gun kit pump	SFLOW™ 275 (2F)	Flat	To be ordered separately	-	1.6 + 7.5	-	151.265.001
Wall-mounted with SFLOW™ gun kit pump with rod and filter	SFLOW™ 275 (2F)	Flat	To be ordered separately	Ø 25	1.6 + 7.5	●	151.265.002

AIRLESS 30C25 PAINT PUMP MOBILE KITS WITH SWIVEL FITTING SFLOW™ GUN

Kit designation	Gun type	Tip guard	Tip	Suction rod	Hoses * Length (m)	Pump output filter	Part number
Mobile with SFLOW™ gun kit pump and 6L hopper	SFLOW™ 275 (2F)	Reversible	Tip Top 12-13 (315)	6L hopper	1.6 + 7.5	-	151.265.003
Mobile with SFLOW™ gun kit pump with rod and filter	SFLOW™ 275 (2F)	Reversible	Tip Top 12-13 (315)	Ø 25	1.6 + 7.5	●	151.265.004

* 3,2 and 4,8mm diameter

AIRLESS spray guns accessories

TRIGGERS

Description	Part number
2 finger trigger	129.740.006
4 finger trigger	129.740.007

MAINTENANCE KITS

Description	Part number
Maintenance kit for Sflow™ 275 (needle and spring)	129.740.901
Maintenance kit for Sflow™ 450 (needle and spring)	129.740.902
Seal kit - O'ring (x10)	150.040.341
Seal kit - cartridge (x10)	109.420.298
F 1/2" JIC - M 1/4" NPSM fitting for Sflow™ gun	050.123.304

FILTER

Description	Materials	Color	Recommended tips	Part number
200 mesh (74 µm) handle filter	stainless steel	red	04-XX to 06-XX	129.740.081
200 mesh (74 µm) handle filter	PA	red	04-XX to 06-XX	129.740.181
150 mesh (100 µm) handle filter	stainless steel	blue	06-XX to 12-XX	129.740.082
150 mesh (100 µm) handle filter	PA	blue	06-XX to 12-XX	129.740.182
100 mesh (150 µm) handle filter	stainless steel	yellow	12-XX to 18-XX	129.740.083
100 mesh (150 µm) handle filter	PA	yellow	12-XX to 18-XX	129.740.183
50 mesh (300 µm) handle filter	stainless steel	white	18-XX to 100-XX	129.740.084
50 mesh (300 µm) handle filter	PA	white	18-XX to 100-XX	129.740.184

RECOMMENDED HOSES

Description	Fluid hose diameter (mm)	Maximum fluid pressure (bar)	Hose length (m)	Fitting	Part number
Whip end fluid hose - F1/2" fitting	3.2	240	1.6	050.102.301	050.451.155
Fluid hose phosphor- F1/2" fitting	4.8	240	7.5	050.102.301	050.450.605
Whip end fluid hose - F1/2" fitting	4.8	240	1.6	050.102.301	050.450.654
Fluid hose phosphor - F1/2" fitting	6.3	240	7.5	050.102.301	050.450.111
Whip end fluid- F1/2" fitting	6.3	240	1.6	905.160.201	050.450.155
Fluid hose - F1/2" fitting	9.52	425	10	905.160.201	76085
Whip end fluid- F1/2" fitting	6.3	450	1.6	905.160.201	050.450.951
Fluid hose phosphor - F1/2" fitting	9.52	425	14	905.160.201	76842

AIRLESS spray guns accessories



REVERSIBLE MANIFOLD FOR SFLOW™

- Select the reversible manifold and its dedicated Tip Top tips for high working cadency. Thanks to the reversible system you can save time. Extremely quick unplugging without any tool. Its easy to change tips without removing the manifold.

TIP GUARDS FOR REVERSIBLE TIPS

Description	Fitting	Tightening type	Part number
Reversible Manifold for Tip Top tips	M25x175	manual	132.740.200

REVERSIBLE TIP TOP TIPS

- Based on Sames Kremlin's protocole, every single tip is unitary tested. With the selection of best quality material, the tips have the longest lifetime. Fast cleaning of plugged tip and fast tip changes.

Description	Part number
TIP TOP reversible tip XX-XX	000.40X.XXX
Pack of 10 seals for reversible TIP TOP tips	134.740.007
Servicing kit (seat (x4) and seals (x4))	129.740.907

The choice of the tip must be done according to the desired flowrate in order to achieve a good finish and reduce paint costs. An AIRLESS tip needs to be replaced frequently in order to maintain the original transfer efficiency.

To obtain tip part number, replace the crosses by the engraved tip number preceded by 000.40X.XXX. Example: use part number 000.402.513 to obtain Tip n°25.13.

We recommend tips

- from 04 to 14 for industry
- from 18 to 40 for anti-corrosion
- from 45 to 100 for high viscosity

Water output 70 bar	Fan width Angle	Ø Orifice (inch) Caliber	12/16 cm		17/21 cm		22/ 24.5 cm		25/29 cm		29/33 cm		33/37 cm		38/44 cm		138 bar 2,002 psi			
			2XX XX-07	3XX XX-09	4XX XX-11	5XX XX-13	6XX XX-15	7XX XX-17	8XX XX-19	Output in water										
0.22 l/mn	04	0,009	209	309	409	509											0.33 l/mn			
		04	04-07	04-09	04-11	04-13														
0.33 l/mn	06	0,011	211	311	411	511	611											0.49 l/mn		
		06	06-07	06-09	06-11	06-13	06-15													
0.45 l/mn	09	0,013	213	313	413	513	613	713											0.69 l/mn	
		09	09-07	09-09	09-11	09-13	09-15	09-17												
0.60 l/mn	12	0,015	215	315	415	515	615	715											0.91 l/mn	
		12	12-07	12-09	12-11	12-13	12-15	12-17												
0.72 l/mn	14	0,017	217	317	417	517	617	717	817											1.17 l/mn
		14	14-07	14-09	14-11	14-13	14-15	14-17	14-19											
0.95 l/mn	18	0,019	219	319	419	519	619	719	819											1.47 l/mn
		18	18-07	18-09	18-11	18-13	18-15	18-17	18-19											
1.33 l/mn	25	0,021			421	521	621	721	821											1.79 l/mn
		25			25-11	25-13	25-15	25-17	25-19											
1.6 l/mn	30	0,023			423	523	623	723	823											2.15 l/mn
		30			30-11	30-13	30-15	30-17	30-19											
2.175 l/mn	40	0,025			425	525	625	725	825											2.54 l/mn
		40			40-11	40-13	40-15	40-17	40-19											
2.38 l/mn	45	0,029		329	429	529	629	729	829											3.42 l/mn
		45		45-09	45-11	45-13	45-15	45-17	45-19											
3.78 l/mn	68	0,033			433	533	633	733	833											4.42 l/mn
		68			68-11	68-13	68-15	68-17	68-19											
5.11 l/mn	100	0,036				539	639	739	839											5.42 l/mn
		100				100-13	100-15	100-17	100-19											



FLAT MANIFOLD FOR SFLOW™

- Select the flat manifold for two kinds of tips, standard airless tips for high precision and performance and double-insert SKILL tips for air consumption reduction and easy cleaning.

FLAT MANIFOLD FOR STANDARD AND SKILL TIPS

Description	Fitting	Tightening type	Part number
Flat Manifold for flat tips (standard and SKILL)	M25x125	Manual	132.740.100



FLAT TIPS

Flat tips ensure high precision and performance; The choice of the tip must be done according to the desired flowrate in order to achieve a good finish and reduce paint costs. An AIRLESS tip needs to be replaced frequently in order to maintain the original transfer efficiency.

Part number: 0000XX.XX (replace of the X by the number read on the table).

FLAT TIPS

Size	Equivalent diameter (in mm-thousandth inches)	Fluid output at 140 bar (l/mn)	Tip Diaphragm	Handle filter (MESH)	Angle	Width of fan at 25 cm											
						18°	30°	40°	50°	60°	67°	75°	82°	88°	94°		
03	0.18/0.007	0.23	09	red (200)		03.03	03.05	03.07									
04	0.23/0.009	0.31	09	red (200)		04.03	04.05	04.07	04.09	04.11	04.13						
06	0.28/0.011	0.46	12	blue (150)		06.03	06.05	06.07	06.09	06.11	06.13	06.15					
09	0.33/0.013	0.63	15	blue (150)		09.05	09.05	09.07	09.09	09.11	09.13	09.15	09.17				
12	0.38/0.015	0.86	15	blue (150)				12.07	12.09	12.11	12.13	12.15	12.17	12.19			
14	0.41/0.016	1.01	18	blue (150)	Number engraved on the tip		14.05	14.07	14.09	14.11	14.13	14.15	14.17	14.19			
18	0.46/0.018	1.34	18	yellow (100)					18.09	18.11	18.13	18.15	18.17	18.19			
20	0.51/0.020	1.50	20	yellow (100)				20.05	20.07	20.09	20.11	20.13	20.15	20.17	20.19		
25	0.55/0.021	1.77	20	yellow (100)						25.11	25.13	25.15	25.17	25.19			
30	0.61/0.024	2.25	25	yellow (100)				30.07	30.09	30.11	30.13	30.15	30.17	30.19			
40	0.66/0.026	2.80	25	white (50)						40.11	40.13	40.15	40.17	40.19			
45	0.74/0.029	3.34	33	white (50)				45.07		45.11	45.13	45.15	45.17	45.19	45.21		
68	0.91/0.036	5.30	33	white (50)						68.11	68.13	68.15	68.17	68.19			

DOUBLE-INSERT SKILL TIPS

With its design, the SKILL tips offers high quality finish with lower air consumption and easy cleaning. To build your part number: 000.20X.XXX (replace of the X by the number read on the table).

SKILL TIPS

Equivalent angle, practical		25°	35°	40°	50°	55°	65°	70°	80°	90°
Fan width identification - spray tip marking		05	07	09	11	13	15	17	19	21
Minimum fan width in inches @ 10'		3.1	4.9	6.7	8.7	9.8	11.4	13.0	15.0	17.3
Minimum fan width in cm @ 25.4 cm		8.0	12.5	17.0	22.0	25.0	29.0	33.0	38.0	44.0
Maximum fan width in inches @ 10'		4.3	6.3	8.3	9.6	11.4	13.0	14.6	17.3	22.0
Maximum fan width in cm @ 25.4 cm		11.0	16.0	21.0	24.5	29.0	33.0	37.0	44.0	56.0
Tip caliber	Fluid output in water									
	at 70 bar (1015 psi)		at 138 bar (2000 psi)							
Sames Kremlin	in cc/ mn	in oz/ mn	in cc/ mn	in oz/ mn						
03	150	5.1	250	8.5	03.07	03.09	03.11	03.13		
04	220	7.5	330	11.2	04.07	04.09	04.11	04.13		
06	330	11.2	490	16.7	06.07	06.09	06.11	06.13	06.15	
07	390	13.3	600	20.4	07.05	07.07	07.09	07.11	07.13	07.15
09	450	15.3	690	23.5	09.07	09.09	09.11	09.13	09.15	09.17
12	600	20.4	910	30.9				12.13	12.15	12.17
14	720	24.5	1170	39.8				14.13	14.15	14.17 14.19
18	950	32.3	1470	50.0				18.13	18.15	18.17 18.19

HANDLE

SWIVEL FITTINGS

Description	Thread	Part number
Swivel fitting, model F 1/2 JIC - M 1/2 JIC	F 1/2 JIC - M 1/2 JIC	129.670.405
Swivel fitting, model F 1/2 JIC - M 1/4 NPSM	F 1/2 JIC - M 1/4 NPSM	129.670.415
Handle fitting, model F 1/2 JIC - M 1/4 NPSM	F 1/2 JIC - M 1/4 NPSM	050.123.304

UNPLUGGING NEEDLES FOR FLAT TIPS

UNPLUGGING NEEDLES FOR FLAT TIPS

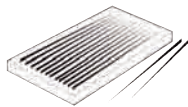

Description	Tip Size (mm)	Quantity	Part number
Unpluging needles	≤ 0.9	12	000.094.000
Unpluging needles	≥ 0.9	12	000.094.002

AIRLESS AS2 Spray Gun - stainless steel

Very compact gun with possibility of circulation

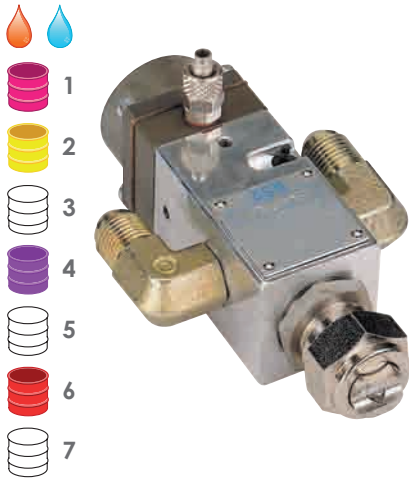

FEATURES

- Miniature size
- Wide range of AIRLESS® tips
- Lightweight design

BENEFITS

- Great for small systems with size restrictions
- Provides many patterns choices
- Makes it possible to mount more guns on a reciprocator without exceeding the weight limit

SPECIFICATIONS

Maximum fluid pressure (bar)	120
Fluid flow rate (l/mn)	upon Tips
Weight (g) (gun only)	250
Maximum Fluid Temperature (°C)	50
Body of the gun	Aluminium
Wetted parts	Stainless steel
Seat	Carbide

FITTINGS

Power supply	Gun	Fitting
Fluid	F 1/8" NPS	M 1/8" NPT - M 1/2 JIC
Control air	F M5	M M5 - Hose 4 x 6

CONFIGURATION OF THE AS2 AIRLESS GUN

Description	Part number
AIRLESS AS 2 w/o tip	135.972.001
AIRLESS tips	See table pages 23-24
Mounting support (Ø12 - length 70 mm)	049.351.600

AIRLESS ASI 24 and 40 Spray Guns - stainless steel

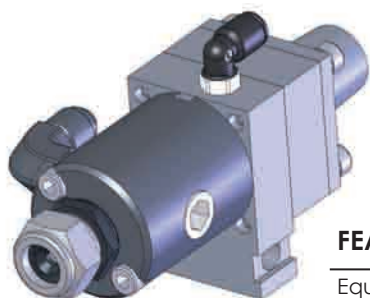

High output.

FEATURES

Equipped with 2 fluid inlets

No spring in the fluid passages

Large choice of tips

BENEFITS

Allows for circulation and saves money by eliminating the need for a 2-way valve on color or flushing

Saves time and money by making it easier to clean, faster color changes and less maintenance

To fit each customer need

SPECIFICATIONS

Trigger air pressure (bar mini)	4 (ASI 24) 5.5 (ASI 40)
Maximum fluid pressure (bar)	240 (ASI 24) 400 (ASI 40)
Fluid output (cc/mn)	Upon tips
Weight (g) (gun only)	700
Maximum Fluid Temperature (°C)	50
Body of the gun	Stainless steel
Wetted parts	Stainless steel, treated stainless steel, PTFE
Seat	Carbide

FITTINGS

Power supply	Gun	Fitting
Fluid ASI 24 and ASI 40	F 1/4" NPS	Elbow M 1/4" NPT - M 1/2 JIC
Control air	F 1/8" BSP	Elbow - M 1/8" BSP - Hose 4 x 6

PART NUMBERS

Description	Part number
AIRLESS ASI 24 w/o tip	129.980.000
AIRLESS ASI 40 w/o tip	129.980.500
AIRLESS tips	(1)
Mounting support Ø 16	049.351.000

(1) to be ordered separately in the table of tips pages 23-24

REPAIR KIT

Description	Part number
Repair kit	129.980.901

REVERSIBLE MANIFOLD FOR ASI

- Select the reversible manifold and its dedicated Tip Top tips for high working cadency. Thanks to the reversible system you can save time. Extremely quick unplugging without any tool. Its easy to change tips without removing the manifold.

TIP GUARDS FOR REVERSIBLE TIPS

Description	Fitting	Tightening type	Part number
Adaptator for Automatic ASI gun	13-16-20 UNEF - M25x175	Manual	129.740.074
Adaptator for Automatic ASI gun	M25x175	Manual	132.740.200
Tip Top reversible tip XX-XX			000.40X.XXX (see table)

Automatic AIRLESS spray guns accessories

DIAPHRAGMS FOR AIRLESS ASI 24 AND 40

Diaphragm has to be chosen depending on nozzle diameter. it increases atomization quality.

PART NUMBERS

Description	Nozzle	Part number
Diaphragm 12	03 - 06	000.029.112
Diaphragm 15	09 - 12	000.029.115
Diaphragm 18	14 - 18	000.029.118
Diaphragm 20	20	000.029.120
Diaphragm 25	30	000.029.125
Diaphragm 60 - standart mounting	-	000.029.160
Fixing nut for the tip		000.152.290

AIRLESS ASI 40 GT and ASI 40 GTV Spray Guns - stainless steel

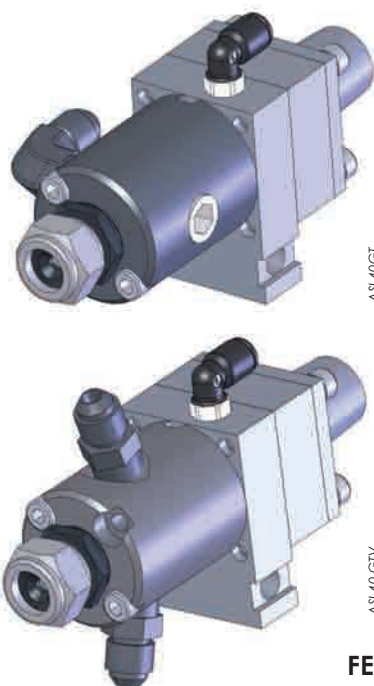

- ASI40 GT, Sames Kremlin original design for abrasive HS (high solids) materials.

- ASI40 GT V, unique Sames Kremlin design for UV materials difficult to flush. Fluid sections with circulation, straight fittings to prevent any material deposit on the GT cartridge and perfect flushing for an increased life time.

Option to position the product inlet on the side or underneath by rotating the front of the gun. Tip mounting without any seal (stainless steel on stainless steel).

AIRLESS spraying = High power preventing any needle blockage and suited for a wide range of products.

FEATURES

- Fitted with a GT cartridge
- Small ball needle
- Simple and unique design (separated small ball needle and cartridge)
- Large choice of tips
- 400 bar spring

BENEFITS

- Strong resistance to very abrasive UV and HS materials for an improved reliability
- For an improved laminar fluid passage
- Very easy to service
- Recommended for large fluid outputs and very high viscosity material applications
- Strong power reducing any needle blockage

SPECIFICATIONS

Trigger air pressure (bar mini)	5.5
Maximum fluid pressure (bar)	400
Fluid output (cc/mn)	Upon Tip
Weight (g) (gun only)	700
Maximum Fluid Temperature (°C)	50
Body of the gun	Stainless steel
Wetted parts	Stainless steel, treated stainless steel, PTFE
Seat	Carbide

FITTINGS

Power supply	Gun	Fittings
Fluid ASI 40 GT	F 1/4" NPS	Elbow - M 1/4" NPT - M 1/2 JIC
Fluid ASI 40 GTV	F 1/4" NPS	Droit - 2 x M 1/4" NPT - M 1/2 JIC
Control air	F 1/8" BSP	Elbow - M 1/8" BSP - Hose 4 x 6

PART NUMBERS

Description	Part number
AIRLESS ASI 40 GT Gun	129.980.600
AIRLESS ASI 40 GTV Gun	129.980.650
AIRLESS tips	See table pages 23-24
Mounting support Ø 16	049.351.000

REPAIR KIT

Description	Part number
Repair kit	129.980.901

AIRLESS Guns

AIRLESS spraying for reduced overspray: can also be used as shutdown valve on a high pressure network.

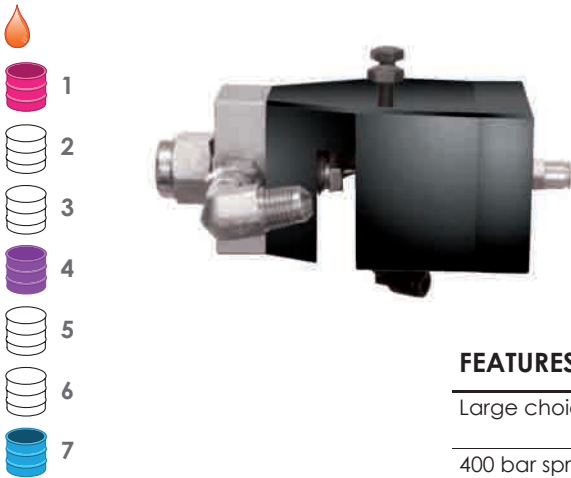

FEATURES

- Large choice of tips
- 400 bar spring

BENEFITS

- Recommended for large fluid outputs and very high viscosity material applications
- Strong power reducing any needle blockage

SPECIFICATIONS

Trigger air pressure (bar mini)	5.5
Maximum fluid pressure (bar)	400
Fluid output (cc/mn)	Upon Tip
Weight (g) (gun only)	585
Maximum Fluid Temperature (°C)	50
Body of the gun	Aluminium
Wetted parts	Stell or Stainless steel
Seat	Carbide

FITTINGS

Power supply	Fittings
Fluid	Straight - M 1/8" G - M 1/2 JIC
Control air	Elbow - 2.7 x 4 hose
Mounting support	On Ø 12,5 mm tube

AIRLESS GUN STAINLESS STEEL

Description	Part number
AIRLESS automatic gun stainless steel	151.120.300
AIRLESS tips	(1)

(1) To be ordered separately - see table pages 23-24 - Please note that the Skill tips cannot be used with this gun

REPAIR KIT

Description	Part number
Repair kit	101.331

ADAPTATION PART

Description	Type	Part number
Male adaptation part to be mounted at the front of the gun	M 1/8" G conical	203.948
Female adaptation part (steel) to be mounted at the front of the gun	M 1/4" G cylindrical	630.649
Female adaptation part (stainless steel) to be mounted at the front of the gun	M 1/4" G cylindrical	203.033
Male adaptation part (steel) to be mounted at the front of the gun	F 10 x 100	630.647

Automatic AIRLESS spray guns accessories

TIP FILTER AND DIAPHRAGMS FOR AIRLESS GUNS

Diaphragm has to be chosen depending on nozzle diameter. it increases atomization quality.

TIP FILTER (TO BE MOUNTED AT THE FRONT OF THE GUN)

Description	Thread, retaining nut	Part number
Tip filter non stainless steel (screen 160 mesh - 95 µ)	F 11/16" G - M 11/16" G	101.576
Tip filter non stainless steel (screen 100 mesh - 150 µ)	F 11/16" G - M 11/16" G	101.579

FILTRATION SCREEN

Description	Part number
Screen filtrant Stainless steel - 50 mesh (300 µ)	625.218
Screen filtrant Stainless steel - 100 mesh (150 µ)	625.212
Screen filtrant Stainless steel - 160 mesh (95 µ)	625.216
Pack of 4 filter seals	107.021

DIAPHRAGMS (TO BE MOUNTED AT THE FRONT OF THE GUN)

Description	Nozzle	Part number
Pre-orifice 09	03 - 04	500.109
Pre-orifice 11	06	500.111
Pre-orifice 13	09	500.113
Pre-orifice 16	12 - 14	500.116
Tip fixing nut	-	630.634



FLAT TIPS

Flat tips ensure high precision and performance; The choice of the tip must be done according to the desired flowrate in order to achieve a good finish and reduce paint costs. An AIRLESS tip needs to be replaced frequently in order to maintain the original transfer efficiency.

Part number: 00000 XX.XX (replace of the X by the number read on the table).

FLAT TIPS

Size	Equivalent diameter (in mm-thousandth inches)	Fluid output at 140 bar (l/mn)	Tip Diaphragm	Handle filter (MESH)	Angle	Width of fan at 25 cm										
						18°	30°	40°	50°	60°	67°	75°	82°	88°	94°	
03	0.18/0.007	0.23	09	red (200)		03.03	03.05	03.07								
04	0.23/0.009	0.31	09	red (200)		04.03	04.05	04.07	04.09	04.11	04.13					
06	0.28/0.011	0.46	12	blue (150)		06.03	06.05	06.07	06.09	06.11	06.13	06.15				
09	0.33/0.013	0.63	15	blue (150)		09.05	09.05	09.07	09.09	09.11	09.13	09.15	09.17			
12	0.38/0.015	0.86	15	blue (150)				12.07	12.09	12.11	12.13	12.15	12.17	12.19		
14	0.41/0.016	1.01	18	blue (150)	Number engraved on the tip		14.05	14.07	14.09	14.11	14.13	14.15	14.17	14.19		
18	0.46/0.018	1.34	18	yellow (100)					18.09	18.11	18.13	18.15	18.17	18.19		
20	0.51/0.020	1.50	20	yellow (100)			20.05	20.07	20.09	20.11	20.13	20.15	20.17	20.19		
25	0.55/0.021	1.77	20	yellow (100)						25.11	25.13	25.15	25.17	25.19		
30	0.61/0.024	2.25	25	yellow (100)			30.07	30.09	30.11	30.13	30.15	30.17	30.19			
40	0.66/0.026	2.80	25	white (50)					40.11	40.13	40.15	40.17	40.19			
45	0.74/0.029	3.34	33	white (50)			45.07		45.11	45.13	45.15	45.17	45.19	45.21		
68	0.91/0.036	5.30	33	white (50)					68.11	68.13	68.15	68.17	68.19			

CONICAL TIPS

Conical tips for direct mounting on manual and automatic guns.



CONICAL TIPS

Equivalent diameter (in mm-thousandth inches)	Fluid output at 140 bar (l/mn)	Handle filter (MESH)	Angle	21°	28°	36°	60°
0.71/0.028	0.9	yellow (100)	TC2	500.002			
0.71/0.028	1.4	yellow (100)	TC3		500.003		
1.06/0.42	1.8	white (50)	TC4			500.004	
1.52/0.60	4.2	white (50)	TC9				500.009

ADJUSTABLE FAN TIPS

Adjustable fan tips provide a simultaneous adjustment of fan width and output.

ADJUSTABLE FAN TIPS

Orifice diameter (mm)	Flat tip equivalent caliber (mini-maxi)	Flowrate (water)(l/mn)	Part number
0.18 - 0.41	03 - 14	0.23 - 1.1	254.020
0.28 - 0.51	06 - 20	0.46 - 1.5	000.000.620
0.41 - 0.91	14 - 68	1.1 - 5.3	000.001.468

AIRLESS 40C50 paint pump - stainless steel

Ideal for outputs up to 1.5 litre/mn.

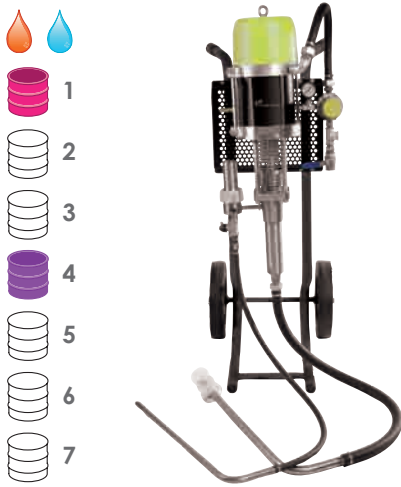

FEATURES

- Large diameter suction rod and high compression ratio
- Stainless steel design
- Simple design , reduced number of spare parts

BENEFITS

- Can be used with a wide range of materials
- Compatible with water-based products
- Easy maintenance

SPECIFICATIONS

Pressure ratio	40/1
Fluid volume per cycle (cm ³)	50
Number of cycles per litre of products	20
Fluid Output at 30 cycles/mn (l/mn)	1.5
Air consumption (m ³ /h) at 30 cycles/mn at 4 bar	21.6
Free flow rate (L/mn)	3
Maximum air inlet pressure (bar)	6
Maximum fluid pressure (bar)	240
Maximum Fluid Temperature (°C)	60
Sound level (dBA)	77
Sealing Packings	Upper sealing Polyfluid + PTFE G Lower sealing GT seal
Wetted parts	Stainless steel
Weight (kg) - wall-mounted	22
Height (cm)	80
Width (cm)	40
Depth (cm)	28

FITTINGS

Fitting	Air inlet (valve)	F 3/4" BSP
	Fluid Inlet	M 26x125
	Fluid output (filter)	M 1/2" JIC

CONFIGURATION OF THE AIRLESS 40C50 PAINT PUMP -STAINLESS STEEL

Set-up	Suction rod (Ø 25)	Drain rod	Air regulator Fluid pressure	Pump output filter	Part number
Wall mounted	-	-	●	-	151.775.050
Wall mounted	●	-	●	-	151.775.100
Wall mounted	-	●	●	●	151.775.150
Wall mounted	●	●	●	●	151.775.200
2 arms cart mounted	●	●	●	●	151.775.400

KITS

Description	Part number
GT seal kit	144.950.091
GT repair kit	144.950.096
Seal kit for 1000-4 air motor	146.270.991
Repair kit for 1000-4 air motor	146.270.995

CARTS AND RODS (SUCTION AND FLUSHING)

Description	Part number
Two Post Cart w/o plate	051.221.000
Two Post Pump Mounting Plate	056.100.199
Easyflow suction rod Ø25 plunging tube length 600 mm	149.596.150
Easyflow suction rod Ø25 plunging tube length 1000mm (for 200 liters drums)	149.596.160
Stainless steel flushing rod F18 x 125	049.596.000
Filter	155.580.400



AIRLESS 40C50 MOBILE PAINT PUMP READY TO SPRAY EQUIPED WITH SWIVEL FITTING SFLOW™ GUN

Kit designation	Gun type	Tip guard	Tip	Suction rod (Ø 25)	Drain rod	Hoses * Length (m)	Pump output filter	Part number
Mobile pump with SFLOW™ gun kit	SFLOW™ 275 (2F)	Reversible	Tip Top 12-13 (515)	●	●	1.6 + 7.5	●	151.265.105

AIRLESS 40C50 WB paint pump - stainless steel

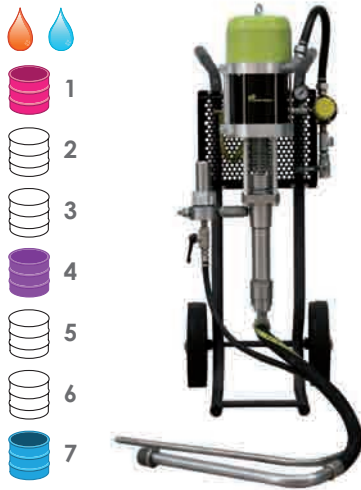

Recommended for high viscosity products such as water-based and high solid paints. Ideal for outputs up to 1.5 litre/mn.

FEATURES

- Large suction fluid passage
- Puls-Absorber™ device
- Stainless steel design
- Stainless steel strainer
- Simple design , reduced number of spare parts

BENEFITS

- For high viscosity materials
- Stable and smooth flow
- Compatible with water-based products
- Long service life and good reliability
- No crushing possible
- Easy maintenance

SPECIFICATIONS

Pressure ratio	40/1
Fluid volume per cycle (cm³)	50
Number of cycles per litre of products	20
Fluid Output at 30 cycles/mn (l/mn)	1.5
Air consumption (m³/h) at 30 cycles/mn at 4 bar	21.6
Free flow rate (L/mn)	3
Maximum air inlet pressure (bar)	6
Maximum fluid pressure (bar)	240
Maximum Fluid Temperature (°C)	60
Sound level (dBA)	77
Sealing Packings	Upper sealing Lower sealing
	Polyfluid + PTFE G GT seal
Wetted parts	Stainless steel
Weight (kg) - wall-mounted	22
Height (cm)	92
Width (cm)	40
Depth (cm)	28

FITTINGS

Fitting	Air inlet (valve)	F 3/4" BSP
	Air outlet (option atomization air kit)	M 1/4" NPS
	Fluid Inlet	M 1" G
	Fluid output (filter)	M 1/2" JIC

CONFIGURATION OF THE AIRLESS 40C50 WB PAINT PUMP - STAINLESS STEEL

Set-up	Suction rod (Ø 1")	Drain rod	Air regulator Fluid pressure	Pump output filter	Part number
Wall mounted	●	●	●	●	151.775.550
2 arms cart mounted	●	●	●	●	151.775.500

KITS

Description	Part number
WB seal kit	144.950.991
Repair kit	144.950.992
Seal kit for 1000-4 air motor	146.270.991
Repair kit for 1000-4 air motor	146.270.995

CARTS AND RODS (SUCTION AND FLUSHING)

Description	Part number
Two Post Cart w/o plate	051.221.000
Two Post Pump Mounting Plate	056.100.199
Suction rod 1"	921.270.101
Stainless steel flushing rod F18 x 125	049.596.000
Filter	155.581.450

AIRLESS 40C100 paint pump - stainless steel

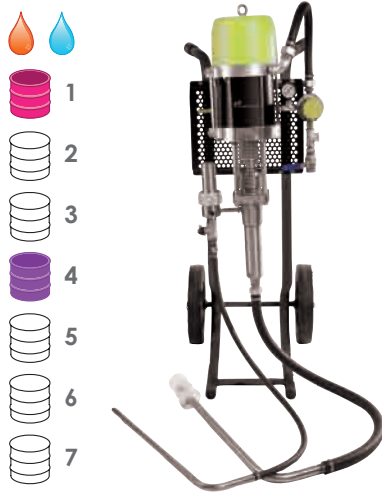

Ideal for feeding two guns.

FEATURES

Simple design, reduced number of spare parts
Large diameter suction rod and high compression ratio

BENEFITS

Easy maintenance
Can be used with a wide range of materials

SPECIFICATIONS

Pressure ratio	40/1
Fluid volume per cycle (cm ³)	100
Number of cycles per litre of products	10
Fluid Output at 30 cycles/mn (l/mn)	3
Free flow rate (L/mn)	6
Air consumption (m ³ /h) at 30 cycles/mn at 4 bar	43.2
Maximum air inlet pressure (bar)	6
Maximum fluid pressure (bar)	240
Maximum Fluid Temperature (°C)	60
Sound level (dBA)	80
Sealing Packings	Upper sealing: Polyfluid + PTFE G Lower sealing: GT sealing
Wetted parts	Stainless steel
Weight (kg) - wall-mounted	22
Height (cm)	80
Width (cm)	40
Depth (cm)	28

FITTINGS

Fitting	Air inlet (valve)	F 3/4" BSP
	Air outlet (option atomization air kit)	M 1/4" NPS
	Fluid Inlet	M 26 x 125
	Fluid output (filter)	M 1/2" JIC

CONFIGURATION OF THE AIRLESS 40C100 PAINT PUMP - STAINLESS STEEL

Set-up	Suction rod (Ø 25)	Drain rod	Air regulator Fluid pressure	Pump output filter	Part number
Wall mounted	-	-	●	-	151.785.050
Wall mounted	●	-	●	-	151.785.100
Wall mounted	-	●	●	●	151.785.150
Wall mounted	●	●	●	●	151.785.200
2 arms cart mounted	●	●	●	●	151.785.400

KITS

Description	Part number
GT seal kit	144.960.091
GT repair kit	144.960.096
Seal kit for 2000-4 air motor	146.270.990
Repair kit for 2000-4 air motor	146.270.996

CARTS AND RODS (SUCTION AND FLUSHING)

Description	Part number
Two Post Cart w/o plate	051.221.000
Two Post Pump Mounting Plate	056.100.199
Easyflow suction rod Ø25 plunging tube length 600 mm	149.596.150
Easyflow suction rod Ø25 plunging tube length 1000mm (for 200 liters drums)	149.596.160
Stainless steel flushing rod F18 x 125	049.596.000
Filter	155.580.301

AIRLESS 40C100 PAINT MOBILE PUMP READY TO SPRAY EQUIPED PUMP WITH SWIVEL FITTING SFLOW™ GUN



Kit designation	Gun type	Tip guard	Tip	Suction rod (Ø 25)	Drain rod	Hoses* Length (m)	Pump output filter	Part number
Mobile pump with SFLOW™ gun kit	SFLOW™ 275 (4F)	Reversible	Tip Top 13-14 (517)	●	●	1.6 + 7.5	●	151.265.205

* 4,8 and 6,35mm diameter

AIRLESS 40C100 WB paint pump - stainless steel

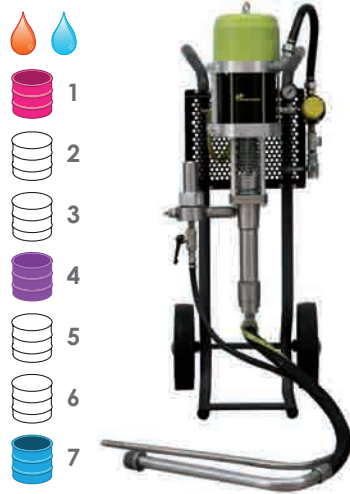

Recommended for high viscosity products such as water-based and high solid paints. Ideal for outputs up to 1.5 litre/mn.

FEATURES

- Large suction fluid passage
- Puls-Absorber™ device
- Stainless steel design
- Stainless steel strainer
- Simple design , reduced number of spare parts

BENEFITS

- For high viscosity materials
- Stable and smooth flow
- Compatible with water-based products
- Long service life and good reliability
- No crushing possible
- Easy maintenance

SPECIFICATIONS

Pressure ratio	40/1
Fluid volume per cycle (cm ³)	100
Number of cycles per litre of products	10
Fluid Output at 30 cycles/mn (l/mn)	3
Air consumption (m ³ /h) at 30 cycles/mn at 4 bar	43.2
Free flow rate (L/mn)	6
Maximum air inlet pressure (bar)	6
Maximum fluid pressure (bar)	240
Maximum Fluid Temperature (°C)	60
Sound level (dBA)	80
Sealing Packings	Upper sealing Polyfluid + PTFE G Lower sealing GT seal
Wetted parts	Stainless steel
Weight (kg) - wall-mounted	22
Height (cm)	92
Width (cm)	40
Depth (cm)	28

FITTINGS

Fitting	Air inlet (valve)	F 3/4" BSP
	Air outlet (option atomization air kit)	M 1/4" NPS
	Fluid Inlet	M 1" G
	Fluid output (filter)	M 3/4" JIC

CONFIGURATION OF THE AIRLESS 40C100 WB PAINT PUMP - STAINLESS STEEL

Set-up	Suction rod (Ø 1")	Drain rod	Air regulator	Fluid pressure	Pump output filter	Part number
Wall mounted	-	-	●	●	-	151.785.510
Wall mounted	-	●	●	●	●	151.785.520
Wall mounted	●	●	●	●	●	151.785.550
2 arms cart mounted	●	●	●	●	●	151.785.500

FITTING TO CONNECT AN AIRLESS GUN KIT

Description	Part number
Adaptator stainless steel F 3/4" JIC/M 1/2" JIC	905.160.219

KITS

Description	Part number
WB seal kit	144.960.891
WB repair kit	144.960.892
Seal kit for 2000-4 air motor	146.270.990
Repair kit for 2000-4 air motor	146.270.996

CARTS AND RODS (SUCTION AND FLUSHING)

Description	Part number
Two Post Cart w/o plate	051.221.000
Two Post Pump Mounting Plate	056.100.199
Suction rod 1"	921.270.101
Stainless steel flushing rod F18 x 125	049.596.000
Filter	155.581.450



AIRLESS 40C100 WB MOBILE PAINT PUMP READY TO SPRAY EQUIPED WITH SWIVEL FITTING SFLOW™ GUN

Kit designation	Gun type	Tip guard	Tip	Suction rod	Drain rod	Hoses Length (m)	Pump output filter	Part number
Mobile pump with SFLOW™ gun kit	SFLOW™ 275 (4F)	Reversible	Tip Top 13-14 (517)	●	●	1.6 + 7.5	●	151.265.305

AIRLESS 40C260 paint pump - stainless steel

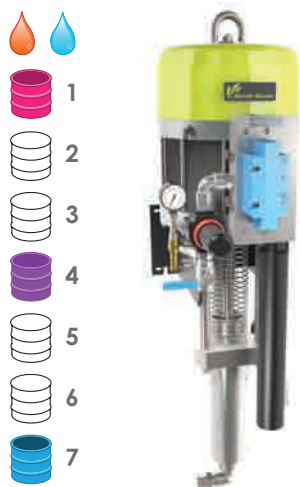

Recommended for any anti-corrosion applications. Available with three different types of sealing packings to meet most customer needs:

- PTFE G + PE: abrasive materials
- GT: solvent-based materials
- PU: water-based materials

FEATURES

- Stainless steel design
- Rugged design
- Air motor muffler included

BENEFITS

- Compatible with water-based materials
- Well-suited for anti-corrosion materials
- Excellent performances and easy maintenance in hard to reach places
- Very silent pump for better comfort of the operator

SPECIFICATIONS

Pressure ratio	40/1
Fluid volume per cycle (cm ³)	240
Number of cycles per litre of products	4
Fluid Output at 20 Cycles/mn (l/mn)	4.8
Free flow rate (L/mn)	14.4
Air Consumption @ 20 CPM at 5 bar	96.8
Maximum air inlet pressure (bar)	6
Maximum fluid pressure (bar)	240
Maximum Fluid Temperature (°C)	60
Sound level (dBA)	85
Sealing Packings	Upper sealing: PTFE G + PE or GT or PU (upon model) Lower sealing: GT or PU sealing (upon model)
Wetted parts	Stainless steel, Carbide, Hard chromed stainless steel
Weight (kg) - wall-mounted	110
Height (cm)	108
Width (cm)	64
Depth (cm)	32.5

FITTINGS

Fitting	Air Inlet	F 3/4" BSP
	Fluid Inlet	M 38 x 150/F 1"
	Fluid Outlet	M 3/4" JIC

CONFIGURATION OF THE AIRLESS 40C260 PAINT PUMP - STAINLESS STEEL

Set-up	Upper sealing	Lower se aling	Suction rod (1")	Drain rod	Air regulator Fluid pressure	Pump output filter	Part number
Wall mounted	PTFE G + PE	GT	-	-	●	-	151.870.500
Wall mounted	PTFE G + PE	GT	-	-	●	●	151.870.800
Wall mounted	GT	GT	-	-	●	●	151.870.670
Wall mounted	PU	PU	-	-	●	●	151.870.660
Wall mounted	PTFE G + PE	GT	●	-	●	●	151.870.600
Cart-mounted	PTFE G + PE	GT	●	-	●	●	151.870.700

KITS

Description	Part number
Seal kit H130	144.025.090
Repair kit H130-2	144.025.695
Repair kit H130	144.025.095
Seal kit 5000-4-2 air motor	146.280.991
Seal kit 5000-4 air motor	146.280.990
Repair kit 5000-4-2 air motor	146.280.996
Repair kit 5000-4 air motor	146.280.995

CARTS AND RODS (SUCTION AND FLUSHING)

Description	Part number
Two Reinforced Arms w/o mounting plate	051.231.000
Pump bracket	051.341.206
Suction rod Ø1"	921.270.101
Stainless steel flushing rod F18 x 125	049.596.000
Pack of 2 strags 1"-M6	151.730.114
Fluid filter	155.581.400

AIRLESS 53C120 paint pump - stainless steel



AIRLESS unit especially designed for industrial coating applications.
Ideal for feeding two guns.

FEATURES

- Cart-mounted pump
- Rugged design
- Stainless steel design
- Simple design , reduced number of spare parts
- Large diameter suction rod and high compression ratio

BENEFITS

- Can be used in most industrial areas
- Adapted for construction sites
- Compatible with water-based materials
- Easy maintenance
- Can be used with a wide range of materials

SPECIFICATIONS

Pressure ratio	53/1
Fluid volume per cycle (cm ³)	124
Number of cycles per litre of products	8
Fluid Output at 30 cycles/mn (l/mn)	3.7
Free flow rate (L/mn)	7.4
Air consumption (m ³ /h) at 30 cycles/mn at 4 bar	71
Maximum air inlet pressure (bar)	6
Maximum fluid pressure (bar)	318
Maximum Fluid Temperature (°C)	60
Sound level (dBA)	72
Sealing Packings	Upper sealing Leather/PE Lower sealing Leather/PE
Wetted parts	Stainless steel
Weight (kg)	90
Height (cm)	130
Width (cm)	74
Depth (cm)	83

FITTINGS

Fitting	Air inlet (valve)	F 3/4" BSP
	Fluid Inlet	M 26 x 125
	Fluid output (filter)	M 3/4" JIC

CONFIGURATION OF THE AIRLESS 53C120 PAINT PUMP

Set-up	Suction rod (1")	Drain rod	Fluid pressure regulator	Pump output filter	Part number
Cart-mounted	●	-	●	●	151.245.953

REPAIR KITS

Description	Part number
Leather/PE seal kit fluid section	105.247
Seal motor kit	146.320.090
Silencer kit	146.320.091
Distributor kit	146.320.092
Distributor seal kit	146.320.093

CARTS AND RODS (SUCTION AND FLUSHING)

Description	Part number
Suction rod 1"	921.270.101
Stainless steel flushing rod F18x125	049.596.000
Cart	208690
Fluid filter	155.581.400

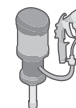

AIRLESS 53C120 READY TO SPRAY MOBILE EQUIPED PUMP WITH SWIVEL FITTING SFLOW™ GUN

Kit designation	Gun type	Tip guard	Tip	Suction rod	Drain rod	Hoses* Length (m)	Pump output filter	Part number
Mobile pump with SFLOW™ gun kit	SFLOW™ 450 (4F)	Reversible	Tip Top 18-13 (519)	●	●	1.6 + 14	●	151.265.404

AIRLESS 65C260 paint pump - stainless steel

Recommended for anti-corrosion applications.

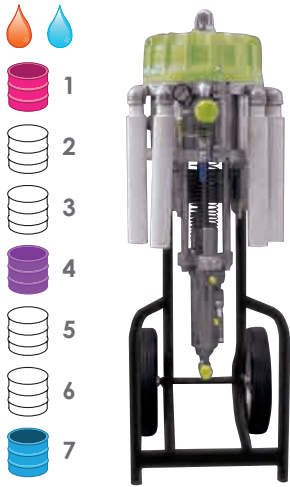

FEATURES

- Stainless steel design
- Rugged design
- Air motor muffler included
- Pressure ratio 65/1

BENEFITS

- Compatible with water-based materials Well-suited for anti-corrosion materials
- Excellent performances and easy maintenance in hard to reach places
- Very silent pump for better comfort of the operator
- High power, compatible with long hose lengths

SPECIFICATIONS

Pressure ratio	65/1
Fluid volume per cycle (cm ³)	240
Number of cycles per litre of products	4
Fluid Output at 30 cycles/mn (l/mn)	4.8
Free flow rate (L/mn)	14.4
Air Consumption @ 20 CPM at 5 bar	157.3
Maximum air inlet pressure (bar)	6
Maximum fluid pressure (bar)	390
Maximum Fluid Temperature (°C)	60
Sound level (dBA)	78
Sealing Packings	Upper sealing PTFE G + PE Lower sealing GT sealing
Wetted parts	Stainless steel hard chromed. Stainless steel. Carbide
Weight (kg) - wall-mounted	86
Height (cm)	112
Width (cm)	48
Depth (cm)	50

FITTINGS

Fitting	Air Inlet	F 3/4" BSP
	Fluid Inlet	M 38 x 1.50
	Fluid Outlet	M 3/4" JIC

CONFIGURATION OF THE AIRLESS 65C260 PAINT PUMP - STAINLESS STEEL

Set-up	Suction rod (Ø25)	Drain rod	Air regulator Fluid pressure	Pump output filter	Part number
Wall mounted	●	-	●	●	151.880.600
Cart-mounted	●	-	●	●	151.880.700

KITS

Description	Part number
Seal kit	144.025.090
Repair kit 260-2	144.025.695
Repair kit	144.025.095
Seal kit 8000-4-2 air motor	146.258.991
Seal kit 8000-4 air motor	146.259.901
Repair kit 8000-4-2 air motor	146.258.996
Repair kit 8000-4 air motor	146.259.905

CARTS AND RODS (SUCTION AND FLUSHING)

Description	Part number
Two Reinforced Arms w/o mounting plate	051.231.000
Pump bracket	051.341.206
Suction rod Ø25 plunging tube length 600 mm	049.597.100
Stainless steel flushing rod F18 x 125	049.596.000
1 arm cart	051.730.110
Fluid filter	155.581.400

AIRLESS 80C220 paint pump - stainless steel

AIRLESS unit especially designed for industrial coating applications. Ideal for feeding two guns.



FEATURES

- Cart-mounted pump
- Rugged design
- Stainless steel design
- Simple design , reduced number of spare parts
- Large diameter suction rod and high compression ratio

BENEFITS

- Can be used in most industrial areas
- Adapted for construction sites
- Compatible with water-based materials
- Easy maintenance
- Can be used with a wide range of materials

SPECIFICATIONS

Pressure ratio	80/1
Fluid volume per cycle (cm ³)	220
Number of cycles per litre of products	4.5
Fluid Output at 30 cycles/mn (l/mn)	6.6
Free flow rate (L/mn)	13.6
Air consumption (m ³ /h) at 30 cycles/mn at 4 bar	190
Maximum air inlet pressure (bar)	6
Maximum fluid pressure (bar)	480
Maximum Fluid Temperature (°C)	60
Sound level (dBA)	72
Sealing Packings	Upper sealing Leather/PE Lower sealing Leather/PE
Wetted parts	Stainless steel
Weight (kg)	125
Height (cm)	136
Width (cm)	74
Depth (cm)	83

FITTINGS

Fitting	Air inlet (valve)	F 3/4" BSP
	Fluid Inlet	1"
	Fluid output (filter)	M 3/4" JIC

CONFIGURATION OF THE AIRLESS 80C220 PAINT PUMP - STAINLESS STEEL

Set-up	Suction rod	Drain rod	Fluid pressure regulator	Filter pump outlet	Part number
Cart-mounted	●	-	●	●	151.245.980

REPAIR KITS

Description	Part number
Leather/PE seal kit	106.284
Air motor seal kit	146.340.090
Silencer kit	146.320.091
Distributor kit	146.320.092
Distributor seal kit	146.320.093

CARTS AND RODS (SUCTION AND FLUSHING)

Description	Part number
Suction rod 1"	921.270.101
Stainless steel flushing rod F18x125	049.596.000
Cart	208690
Fluid filter	155.582.050

AIRLESS Flowmax® pumps

AIRLESS 34F60 FLOWMAX® paint pump - stainless steel



Unique design with external valves for an easy maintenance. Flowmax technology ensures total sealing. Quick inversion of this pump allows for a perfectly stable fan shape at the gun. Performance, extended lifetime, reliability.

FEATURES

- External valves assembly
- Floating piston
- Sealing done by a Superlife™ bellow seal

BENEFITS

- Easy maintenance
- Fast inversions and very high efficiency
- High reliability
- No more lubricant cups
- Leak free
- Total sealing between pump and its environment, ideal to work with moisture-sensitive catalysts
- Ideal for UV and pre-catalyzed materials
- Fluid discharge without retention of a wide range of coating materials
- Compatible with water-based materials
- Constant fluid output pressure

Large and smooth fluid passages

- Stainless steel design
- Balanced fluid section

SPECIFICATIONS

Pressure ratio	34/1
Fluid volume per cycle (cm³)	60
Number of cycles per litre of products	16
Fluid Output at 30 cycles/mn (l/mn)	1.8
Air consumption (m³/h) at 30 cycles/mn at 4 bar	22
Free flow rate (L/mn)	3.6
Maximum air inlet pressure (bar)	6
Maximum fluid pressure (bar)	200
Maximum Fluid Temperature (°C)	50
Sound level (dBA)	71
Sealing packing	Bellows Upper and lower
	Polyethylene GT Polyethylene
Wetted parts	Stainless steel
Weight (kg) - wall-mounted	26.5
Height (cm)	61
Width (cm)	41
Depth (cm)	25

FITTINGS

Fitting	Air inlet (valve)	F 3/4" BSP
	Air outlet (option atomization air kit)	M 1/4" NPS
	Fluid Inlet	M 26 x 125
	Fluid output (filter)	M 1/2 JIC

CONFIGURATION OF THE AIRLESS 34F60 FLOWMAX® PAINT PUMP

Set-up	Suction rod (Ø25)	Drain rod	Air regulator Fluid pressure	Pump output filter	Part number
Wall-mounted	●	●	●	●	151.740.700
1 arm cart	●	●	●	●	151.740.750

KITS

Description	Part number
Seal kit for A2 fluid section	144.910.799
Repair kit for A2 fluid section	144.910.797
Seal kit for external valves	144.910.798
Seal kit for 2000-2 air motor	144.929.902
Repair kit for 2000-2 air motor	144.929.912

CARTS AND RODS (SUCTION AND FLUSHING)

Description	Part number
Two Post Cart w/o plate	051.221.000
Two Post Pump Mounting Plate	056.100.199
Easyflow suction rod Ø25 plunging tube length 600 mm	149.596.150
Easyflow suction rod Ø25 plunging tube length 1000mm (for 200 liters drums)	149.596.160
Stainless steel flushing rod F18 x 125	049.596.000
1 arm cart	051.730.110
Fluid filter	155.580.400



AIRLESS 34F60 FLOWMAX® PAINT PUMP KIT WITH M250 GUN

Description	Gun type	Supplied with aircap	Tip	Suction rod (Ø25)	Drain rod	Atomization air regulator	Hoses Length (m)	Pump output filter	Kit part number
Wall-mounted	M 250	-	Reversible 517 tip	●	●	-	10	●	151.260.870

AIRLESS 40F50 FLOWMAX® paint pump - stainless steel

New generation Flowmax® pump for low volume applications.

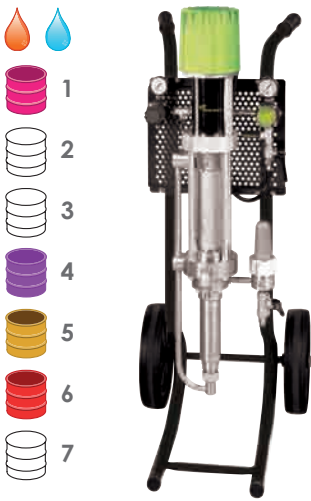

FEATURES

Sealing done by one large stroke bellows
Ergonomic design of fluid passages
Stainless steel design
Balanced fluid section
Mobile piston seal

BENEFITS

High reliability
No more lubricant cups
Leak free
Total sealing - ideal for isocyanates
Ideal for UV and pre-catalyzed materials
Fluid discharge without retention of a wide range of coating materials
Compatible with water-based materials
Constant fluid output pressure
Excellent suction capacity

SPECIFICATIONS

Pressure ratio	40/1
Fluid volume per cycle (cm³)	50
Number of cycles per litre of products	20
Air consumption (m³/h) at 30 cycles/mn at 4 bar	21.6
Fluid Output at 30 cycles/mn (l/mn)	1.5
Free flow rate (L/mn)	3
Maximum fluid pressure (bar)	240
Maximum Fluid Temperature (°C)	50
Maximum air inlet pressure (bar)	6
Sound level (dBA)	72
Sealing packing	Bellows Upper and lower
	Polyethylene GT polyethylene
Wetted parts	Stainless steel
Weight (kg) - wall-mounted	37
Height (cm)	97
Width (cm)	40
Depth (cm)	28

FITTINGS

Fitting	Air inlet (valve)	F 3/4" BSP
	Fluid Inlet	M 26 x 125
	Fluid Outlet	M 1/2" JIC

CONFIGURATION OF THE AIRLESS 40F50 FLOWMAX® PAINT PUMP - STAINLESS STEEL

Set-up	Suction rod (Ø25)	Drain rod	Air regulator Fluid pressure	Pump output filter	Part number
Wall mounted	●	●	●	●	151.776.200
2 arm cart-mounted	●	●	●	●	151.776.400

KITS

Description	Kit part number
Seal kit	144.950.291
Repair kit	144.950.292
Seal kit for 1000-4 air motor	146.270.991
Repair kit for 1000-4 air motor	146.270.995

CARTS AND RODS (SUCTION AND FLUSHING)

Description	Kit part number
Two Post Cart w/o plate	051.221.000
Two Post Pump Mounting Plate	056.100.199
Easyflow suction rod Ø25 plunging tube length 600 mm	149.596.150
Easyflow suction rod Ø25 plunging tube length 1000mm (for 200 liters drums)	149.596.160
Stainless steel flushing rod F18 x 125	049.596.000
Fluid filter	155.580.400

AIRLESS 40F100 FLOWMAX® paint pump - stainless steel

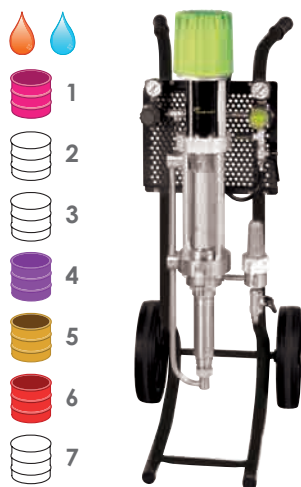

New generation Flowmax® pump, ideal for feeding two guns.

FEATURES

Sealing done by one large stroke bellows

Ergonomic design of fluid passages

Stainless steel design

Balanced fluid section

Mobile piston seal

BENEFITS

High reliability

No more lubricant cups

Leak free

Total sealing between pump and its environment, ideal to work with moisture-sensitive catalysts

Ideal for UV and pre-catalyzed materials

Fluid discharge without retention of a wide range of coating materials

Compatible with water-based materials

Constant fluid output pressure

Excellent suction capacity

SPECIFICATIONS

Pressure ratio	40/1
Fluid volume per cycle (cm ³)	100
Number of cycles per litre of products	10
Fluid Output at 30 cycles/mn (l/mn)	3
Air consumption (m ³ /h) at 30 cycles/mn at 4 bar	43.2
Free flow rate (L/mn)	6
Maximum fluid pressure (bar)	240
Maximum Fluid Temperature (°C)	50
Maximum air inlet pressure (bar)	6
Sound level (dBA)	77
Sealing packing	Bellows Upper and lower
	Polyethylene GT Polyethylene
Wetted parts	Stainless steel
Weight (kg) - wall-mounted	42
Height (cm)	97
Width (cm)	40
Depth (cm)	28

FITTINGS

Fitting	Air inlet (valve)	F 3/4" BSP
	Fluid Inlet	M 26x125
	Fluid Outlet	M 1/2" JIC

CONFIGURATION OF THE AIRLESS 40F100 FLOWMAX® PAINT PUMPS- STAINLESS STEEL

Set-up	Suction rod (Ø25)	Drain rod	Air regulator Fluid pressure	Pump output filter	Part number
Wall mounted	●	-	●	-	151.786.100
Wall mounted	●	●	●	●	151.786.200
2 arm cart-mounted	●	●	●	●	151.786.400

KITS

Description	Part number
Seal kit	144.960.291
Repair kit	144.960.292
Seal kit for 2000-4 air motor	146.270.990
Repair kit for 2000-4 air motor	146.270.996

CARTS AND RODS (SUCTION AND FLUSHING)

Description	Part number
Two Post Cart w/o plate	051.221.000
Two Post Pump Mounting Plate	056.100.199
Easyflow suction rod Ø25 plunging tube length 600 mm	149.596.150
Easyflow suction rod Ø25 plunging tube length 1000mm (for 200 liters drums)	149.596.160
Stainless steel flushing rod F18 x 125	049.596.000
Fluid filter	155.580.301

AIRLESS 40F260 FLOWMAX® paint pump - stainless steel

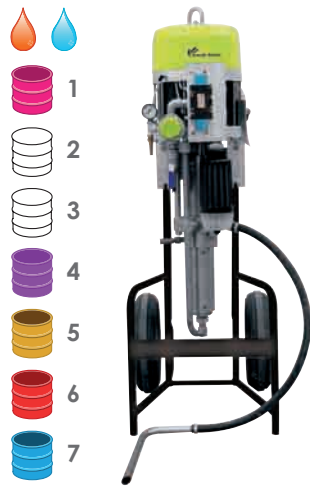

Recommended for anti-corrosion applications. Available with two different types of sealing packings to meet most customer needs:

- GT: solvent-based materials
- PU: water-based materials

FEATURES

Sealing done by one large stroke bellows

Ergonomic design of fluid passages

Stainless steel design
Balanced fluid section
Mobile piston seal

BENEFITS

High reliability
No more lubricant cups
Leak free
Total sealing between pump and its environment, ideal to work with moisture-sensitive catalysts
Ideal for UV and pre-catalyzed materials
Fluid discharge without retention of a wide range of coating materials
Compatible with water-based materials
Constant fluid output pressure
Excellent suction capacity

SPECIFICATIONS

Pressure ratio	40/1
Fluid volume per cycle (cm ³)	240
Number of cycles per litre of products	4
Fluid Output at 20 Cycles/mn (l/mn)	4.8
Free flow rate (L/mn)	14.4
Maximum fluid pressure (bar)	240
Maximum Fluid Temperature (°C)	50
Maximum air inlet pressure (bar)	6
Sound level (dBA)	85
Sealing packing	Bellows Polyethylene Upper GT or PU (upon model) Lower GT or PU sealing (upon model)
Wetted parts	Stainless steel, Carbide, Hard chromed stainless steel
Weight (kg)	70
Height (cm)	112
Width (cm)	65
Depth (cm)	32,5

FITTINGS

Fitting	Air Inlet	F 3/4" BSP
	Fluid Inlet	M 38 x 1.50
	Fluid Outlet	M 3/4" JIC

CONFIGURATION OF THE AIRLESS 40F260 FLOWMAX® PAINT PUMP- STAINLESS STEEL

Set-up	Upper sealing	Lower sealing	Suction rod (Ø25)	Drain rod	Air regulator Fluid pressure	Pump output filter	Part number
Wall mounted	GT	GT	-	-	●	-	151.871.500
Wall mounted	GT	GT	●	-	●	●	151.871.600
Wall mounted	GT	GT	-	-	●	●	151.871.800
Wall mounted	PU	PU	-	-	●	●	151.871.660
Cart-mounted	GT	GT	●	-	●	●	151.871.700

KITS

Description	Part number
H 260F-2 seals kit	144.020.690
H 260F seals kit	144.020.090
H 260F-2 repair kit	144.020.695
H 260F repair kit	144.020.095
Seal kit 5000-4-2 air motor	146.280.991
Seal kit 5000-4 air motor	146.280.990
Repair kit 5000-4-2 air motor	146.280.996
Repair kit 5000-4 air motor	146.280.995

CARTS AND RODS (SUCTION AND FLUSHING)

Description	Part number
Two Reinforced Arms w/o mounting plate	051.231.000
Pump bracket	051.341.206
Suction rod Ø25 plunging tube length 600 mm	049.597.100
Stainless steel flushing rod F18 x 125	049.596.000
Fluid filter	155.581.400

AIRLESS 65F260 FLOWMAX® paint pump - stainless steel

Recommended for corrosion-resistant applications.

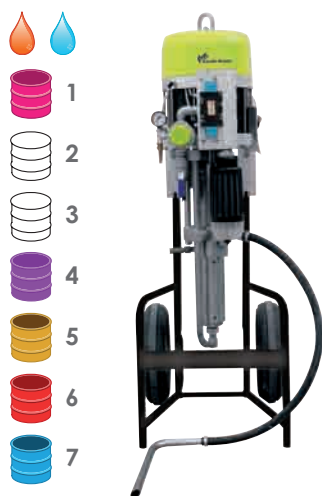

FEATURES

Sealing done by one large stroke bellows

Ergonomic design of fluid passages

Stainless steel design

Balanced fluid section

Mobile piston seal

Pressure ratio 65/1

BENEFITS

High reliability

No more lubricant cups

Leak free

Total sealing between pump and its environment, ideal to work with moisture-sensitive catalysts

Ideal for UV and pre-catalyzed materials

Fluid discharge without retention of a wide range of coating materials

Compatible with water-based materials

Constant fluid output pressure

Excellent suction capacity

High power, compatible with long hose lengths

SPECIFICATIONS

Pressure ratio	65/1
Fluid volume per cycle (cm ³)	240
Number of cycles per litre of products	4
Fluid Output at 20 Cycles/mn (l/mn)	4.8
Free flow rate (L/mn)	14.4
Maximum fluid pressure (bar)	390
Maximum Fluid Temperature (°C)	50
Maximum air inlet pressure (bar)	6
Sound level (dBA)	78
Sealing packing	Bellows: Polyethylene Upper and lower: GT polyethylene
Wetted parts	Stainless steel, carbide, hard chromed stainless steel
Weight (kg)	90
Height (cm)	116
Width (cm)	48
Depth (cm)	50

FITTINGS

Fitting	Air Inlet	F 3/4" BSP
	Fluid Inlet	M 38 x 150
	Fluid Outlet	M 3/4" JIC

CONFIGURATION OF THE AIRLESS 65F260 FLOWMAX® PAINT PUMP - STAINLESS STEEL

Set-up	Suction rod (Ø25)	Drain rod	Air regulator Fluid pressure	Pump output filter	Part number
Wall mounted	●	-	●	●	151.881.600
Cart-mounted	●	-	●	●	151.881.700

KITS

Description	Part number
H 260F-2 seals kit	144.020.690
H 260F seals kit	144.020.090
H 260F-2 repair kit	144.020.695
H 260F repair kit	144.020.095
Seal kit 8000-4-2 air motor	146.258.991
Seal kit 8000-4 air motor	146.259.901
Repair kit 8000-4-2 air motor	146.258.996
Repair kit 8000-4 air motor	146.259.905

CARTS AND RODS (SUCTION AND FLUSHING)

Description	Part number
Two Reinforced Arms w/o mounting plate	051.231.000
Pump bracket	051.341.206
Suction rod Ø25 plunging tube length 600 mm	049.597.100
Stainless steel flushing rod F18 x 125	049.596.000
Fluid filter	155.581.400

AIRLESS Flowmax® pumps accessories

**FILTERS 360, 400 AND 460 BAR
CONFIGURATION OF STEEL FILTERS**

Description	Maximum fluid pressure (bar)	Stainless steel for filter	Thread			Part number
			Inlet	Outlet	Drain	
1/2" bare steel filter	400	cartridge 160µ	F 1/2" G	F 1/2" G	F 1/4" G	104.240
3/4" bare steel filter	400	cartridge 160µ	F 3/4" G	F 3/4" G	F 1/4" G	104.243
1/2" steel filter + drain valve	400	cartridge 160µ	F 1/2" G	F 1/2" G	M 1/2" JIC	104.241
3/4" steel filter + drain valve	400	cartridge 160µ	F 3/4" G	F 3/4" G	M 1/2" JIC	104.244

CONFIGURATION OF STAINLESS STEEL FILTERS

Description	Maximum fluid pressure (bar)	Stainless steel for filter	Thread			Part number
			Inlet	Outlet	Drain	
3/4" stainless steel bare filter	360	12 (280 µm)	F 3/4" NPS (x1)	F 3/4" NPS (x1)	F 3/8" NPS (x1)	155.581.450
Stainless steel Accumulator equipped filter 3/4"	360	12 (280 µm)	M 3/4" BSP	M 3/4" JIC	M 18x125	155.581.400
1" stainless bare steel filter-double screen	480	15 (x2) (360 µm)	F 1" NPS (x1)	F 1" NPS (x1)	F 3/8" NPS (x2)	155.582.000
Stainless steel equipped double screen filter 1"	480	15 (x2) (360 µm)	F 1" G	F 1" G	F 3/8" G	155.582.050
1/2" stainless steel bare filter	400	cartridge 160µ	F 1/2" G	F 1/2" G	F 1/4" G	104.247
1/2" stainless steel bare filter + drain valve	400	cartridge 160µ	F 1/2" G	F 1/2" G	M 1/2" JIC	104.248
3/4" stainless steel bare filter + drain valve	400	cartridge 160µ	F 3/4" G	F 3/4" G	M 1/2" JIC	104090

FILTER ACCESSORIES

Description	Part number
Stainless steel filter fitting length 70 mm (MM 3/8" NPT)	055.580.301
Wall-mounted bracket and screws for 3/8", 3/4" and 1" filter with 9 digits part numbers	155.190.105
Wall-mounted bracket for filters with 6 digits part numbers	204052

SCREEN AND CARTRIDGES FOR FLUID FILTER
SCREEN CONFIGURATION (FILTRATION SURFACE 65 CM²)

Filter number	Filtration size		Nozzle size	Part number
	Micron	Mesh		
1	40	325	3	000.161.101
2	74	200	4	000.161.102
3	90	170	4	000.161.103
4	100	140	4	000.161.104
6	168	85	6	000.161.106
8	210	70	09 & 14	000.161.108
12	280	55	20	000.161.112
15	360	45	30 & 45	000.161.115
20	510	30	> 68	000.161.020
30	750	20	> 68	000.161.030

CONFIGURATION FILTRATION CARTRIDGE STAINLESS STEEL (FILTRATION SURFACE 132 CM²)

Description	Filtration size		Nozzle size	Part number
	Micron	Mesh		
Filtration cartridge Stainless steel	90	170	4	601.241
Filtration cartridge Stainless steel	102	140	4	601.240
Filtration cartridge Stainless steel	160	83	6	601.239
Filtration cartridge Stainless steel	201	65	9 - 20	601.324
Filtration cartridge Stainless steel	350	45	30 - 68	601.238
Filtration cartridge Stainless steel	710	25	> 68	601.237

CONFIGURATION FILTRATION CARTRIDGE STEEL (FILTRATION SURFACE 132 CM²)

Description	Filtration size		Nozzle size	Part number
	Micron	Mesh		
Filtration cartridge steel	90	170	4	601.093
Filtration cartridge steel	102	140	4	601.090
Filtration cartridge steel	160	83	6	601.089
Filtration cartridge steel	201	65	9 - 20	601.287
Filtration cartridge steel	350	45	30 - 68	601.092
Filtration cartridge steel	710	25	> 68	601.084

STRAINERS FOR SUCTION RODS
STRAINERS CONFIGURATION

Pump	Height (mm)	Internal diameter (mm)	Material	Filtration size		Part number
				Micron	Mesh	
40.130-2 / 40.130 F2 / 65.130 / 65.130 F2	112	66	Polyamide	1000	15	149.591.400
40.25/40.50WB	40	48	Stainless steel	1000	15	921.270.102
34.A2 / 40.25 / 40.25F / 40.50 / 40.50F / Easy Flush Ø25	40	48	Stainless steel	1000	15	149.596.152

NOTES

Area with horizontal dashed lines for taking notes.

Airless spraying

Plural component pumps and machines

Fittings and air treatment

Cyclix™ agitators for 20-40-200 l drums



This elevator-agitator for 20-40 to 200l drums features a double-effect jack for a fast lift of a stainless steel cover fitted for a quick material drum change. The cover is equipped with a motorized agitator fitted with blades for low viscosity materials and a full stainless steel rod.

The elevator is coming on a large fixing plate which makes it very stable and easy to install in paint kitchens, existing installations or an essential component of new installations.

FEATURES

Stainless steel (agitator cover, suction and drain rods)
 Adjustable suction rod height
 Suction and return tubes
 Double effect jack with 3 positions command lever: up, stop, down
 The agitator cannot work during elevator movements

BENEFITS

Compatibility with all materials
 No product loss
 Suitable for recirculating
 Important flexibility
 Security

CHARACTERISTICS

Capacity (L)	20 - 40	200
Motor type	Pneumatic	Pneumatic
Reductor type	-	Gear train
Rotation speed (rpm)	60 - 300	5 - 90
Motor torque Nm	2.2	34

CYCLIX™ PART NUMBERS FOR 20 - 40 L DRUMS

Description	Elevator height (mm)	Agitator rod length (mm)	Paddle diameter (mm)	Cover diameter (mm)	Part number
Elevator for 20 -40 l drums	1024 (min) - 1500 (max)	-	-	-	151.081.000
Agitator for 20 -40 l drums	-	400	134	-	154.261.700
Cover for 20 -40 l drums	-	-	-	400	154.261.600
Suction/exhaust kit	-	-	-	-	154.261.800

CYCLIX™ PART NUMBERS FOR 200 L DRUMS

Description	Elevator height (mm)	Agitator rod length (mm)	Paddle diameter (mm)	Cover diameter (mm)	Part number
Elevator for 200 l drums	1510 (mini) - 2410 (maxi)	-	-	-	151.091.000
Agitator for 200 l drums	-	800	370	-	154.261.300
Cover for 200 l drums	-	-	-	635	154.261.200
Suction/exhaust kit	-	-	-	-	154.261.400

RECOMMENDED ACCESSORIES

Description	Part number
1/4" air lubricator + support	154.261.997
Exhaust assembly with oil recovery (length 1 m)	154.261.996
Air feeding kit	154.261.930
Drum roller unit for 200 litres drum	151.098.100
Slotted paddle for thick materials	154.261.952
HP 150 2 liters lubricant can	149.990.017

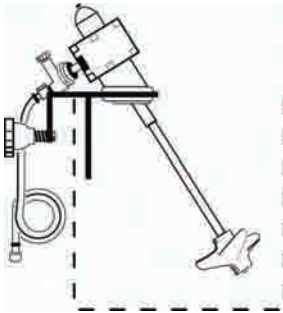

AGITATORS FOR EDGE PAIL MOUNTING

Agitator for barrel edge mounting.
Minimum barrell height of 300 mm.

AGITATORS

Description	Part number
Bare agitator	051.332.610
Agitator with 25 cm hose	051.332.600
Agitator with 5 m hose	049.220.710
System for barrel mounting	049.220.720



AGITATORS ON STAINLESS STEEL COVER

Agitator:
For drums diameter between 295 and 325 mm.
Minimum drum height of 390 mm.

AGITATORS

Description	Part number
Agitator for Ø325 cover	903.290.101

STRAINER FOR CYCLIX™ SUCTION RODS

STRAINER FOR CYCLIX™ SUCTION RODS

Description	Part number
Strainer for cyclix™ suction rods	154.261.940



AIRLESS POLYAMIDE FLUID HOSES

- Those hoses should be chosen according to the diameter, the length and the pressure used in the application.

HOSES CONFIGURATION SINGLE BRAIDED HOSE

Designation Conductive Color	Part number			
	YES Black			
Internal diameter	4.8 (3/16")	6.35 (1/4")	9.52 (3/8")	12.7 (1/2")
Max.operating pressure bar	325	300	225	175
Temperature	up to 100°C			
Cut of 25m without fitting				050.450.005
Fitting alone to screw in				905.060.107
PART NUMBER ACCORDING TO LENGTH WITH FITTINGS per meter				
A and B fittings (free nut)	1/2 JIC	1/2 JIC	3/4 JIC	7/8 JIC
Treated steel fittings Without spring				
0.5 m		76.022	76.035	
1 m	76.010	76.023	76.036	76.049
2 m	76.012	76.025	76.038	76.051
3 m		76.026	76.039	
5 m		76.028	76.041	
6 m	76.016	76.029	76.042	
7 m		76.030	76.043	76.056
8 m		76.031	76.044	76.057
10 m		76.033	76.046	
12 m		76.034		

HOSES CONFIGURATION DOUBLE BRAIDED HOSE

Designation Conductive Color	Part number				
	YES Black				
Internal diameter	6.35 (1/4")	6.35 (1/4")	9.52 (3/8")	9.52 (3/8")	12.7 (1/2")
Max.operating pressure bar	450	500	375	425	375
Temperature	up to 100°C				
PART NUMBER ACCORDING TO LENGTH WITH FITTINGS PER METER					
A and B fittings (free nut)	1/2 JIC	1/2 JIC	3/4 JIC	3/4 JIC	7/8 JIC
Treated steel fittings Without spring					
0.5 m				76.074	
1 m	050.451.001			050.450.905	
2 m		76.064		76.077	76.090
3 m		76.065	050.450.904		76.091
5 m	050.451.002	76.067	050.450.903	76.080	76.093
6 m				76.081	76.094
8 m		76.070			76.096
10 m	050.451.003		050.450.902	76.085	
12 m		76.073		76.086	
14 m				76.842	
18 m				76.844	
20 m			050.450.901		



AIRLESS PTFE FLUID HOSES

For all products, particularly those which are sensitive to air humidity (like silicone) and those which are chemically aggressive.

HOSES CONFIGURATION

Designation	Part number					
	Grey with metallic braid					
Material color	4.8 (3/16")	6.35 (1/4")	9.52 (3/8")	9.52 (3/8")	12.7 (1/2")	12.7 (1/2")
Internal diameter (mm)						
Conductive	YES					
Maximum Operating pressure (bar)	250	250	175	350	350	350
Temperature	≤ 110 °C					
Fittings A and B (free nut)	1/2 JIC	1/2 JIC	3/4 JIC	3/4 JIC	3/4 JIC	7/8 JIC
0.60 m	050.452.010	-	-	-	-	-
0.70 m	-	-	050.451.904	-	-	-
1 m	-	050.452.001	050.451.903	-	-	-
2 m	-	-	050.451.901	76.800	050.452.204	76.872
3 m	-	-	-	76.801	-	76.874
5 m	-	050.452.002	050.451.902	76.802	-	76.928
7 m	-	-	-	76.803	050.452.201	-
10 m	-	-	-	76.914	050.452.203	-

PRODUCT HOSES FOR SUCTION ROD

HOSE FOR SUCTION ROD

Designation	Part number		
	Ø 9.5 mm	Ø 19 mm	Ø 25 mm
Polyethylene hose sleeve			
5 m cut	050.361.005	050.366.051	050.367.001
15 m cut	050.361.004	050.366.052	-
25 m cut	050.361.001	050.366.053	050.367.003
Grooved conical fitting	050.140.517	050.140.545	050.140.543
Nickeled nut fitting	050.271.303	050.271.502	049.595.306
1 wing collar	906.311.234	906.311.207	906.311.204

LUBRICANTS AND GREASES FOR PUMPS

LUBRICANT FOR PUMP PACKINGS

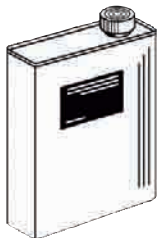

Description	Part number
Lubricants for pump fittings	
T lubricant (125 ml) can for solvent-based paints	149.990.020
Kit of 3 T lubricant cans (2L each)	151.260.820
P lubricant can (2L each) (PU products)	149.990.022
Kit of 3 P lubricant cans (2L each) (PU products)	151.260.823
Grease	
Vaseline 1 kg	560.440.002
Box of 450 g PTFE grease	560.440.001
Box of 1 kg grease special air motor seals	560.440.001
Tube 20g grease special air motor seals	560.440.005
Teflon® grease tube 10 ml	560.440.105
Box of grease (450g)	560.420.005
Glue	
Sealing glue tube	554.180.015
Low strength anaerobic adhesive tube	554.180.010

RC 600 full visor mask

Maximum protection for excellent working conditions, optimal health protection with low operating costs. The RC 600 is compliant with the latest european norms.



FEATURES

- Complete assembly with protection screen
- Light and ergonomic
- Low airflow alarm
- Adjustable head and front protection
- Easy disposable screen protectors

BENEFITS

- Complete protection of the operator face and eyes (against isocyanates especially)
- Reduced fatigue and excellent working conditions for increased productivity
- Constant operator protection
- Suitable for everyone and user-friendly
- Easy maintenance

CONFIGURATION OF THE RC 600 FULL-VISOR MASK

Description	Part number
RC 600 full-visor mask complete	143.400.000
Belt supply air hose assembly	143.400.002

ACCESSORIES

Description	Quantity	Part number
RC 600 full-visor mask alone (without regulator)	1	143.400.007
Screen protector	50	143.400.006

RC 756 respirators

Lightweight, comfortable respirators efficient for each type of paint and compliant with the latest european norms (Respirator: EN 140, Filters: EN 14393).



FEATURES

Respirator body made of silicone
Equipped with large inlet and outlet valves
Double fixing straps
Double filters
Three high performance filters type available (solvented, water-based or multi with isocyanate materials)

BENEFITS

Hypoallergenic and high comfort
Easy breathing
Comfortable
Performance (large diameter), visibility and high level of safety
For an optimal protection whatever the type of paint used

CONFIGURATION OF THE RC 756 RESPIRATOR

Description	Part number
RC 756 respirator	143.380.100
RC 756 respirator for SOLVENT-BASED PAINTS - A1 filters	143.380.200
RC 756 respirator for WATER-BASED PAINTS - A1B1P3 filters	143.380.300
RC 756 respirator for PLURAL COMPONENT PAINTS - ISOCYANATES - A1B1E1K1P3 filters	143.380.400

FILTERS & PRE-FILTERS

Description	Type	Quantity	Part number
Filters for solvented paints	A1	10	143.380.210
Filters for water-based paints	A1B1P3	5	143.380.310
Filters for plural-components-isocyanates	A1B1E1K1P3	5	143.380.410
Pre-filters for A1 filters	-	25	143.380.110

ACCESSORIES

Description	Quantity	Part number
Attach strap	1	143.380.120
Spare inlet/outlet valves	3	143.380.130

Accessories for protection



PROTECTIVE OVERALLS

Protects the operator. Comfortable to wear, giving protection for dust or plush.

- Conforms to European Standards
- Made in non-woven fabric, they come with elasticated wrists and wide trouser legs to protect footwear

PART NUMBERS

Description	Size	Quantity	Part number
Overalls Size S for 5 sets	S	5	564.504.001
Overalls Size M for 5 sets	M	5	564.504.002
Overalls Size L for 5 sets	L	5	564.504.003
Overalls Size XL for 5 sets	XL	5	564.504.004
Overalls Size XXL for 5 sets	XXL	5	564.504.005



PROTECTIVE HOOD

Protects the head and hair.

- Non-woven, light and lets the skin breathe
- Conforms to European Standards

PART NUMBERS

Description	Quantity	Part number
Protective hood	5	043.250.001

NOTES

Area with horizontal dashed lines for taking notes.

Airless spraying

Plural component pumps and machines

Fittings and air treatment

NOTES

A series of horizontal dashed lines for taking notes.

PLURAL COMPONENT PUMPS AND MACHINES

Airless spraying

Plural component pumps and machines

Fittings and air treatment

PU 3000 2l and 4l AIRLESS

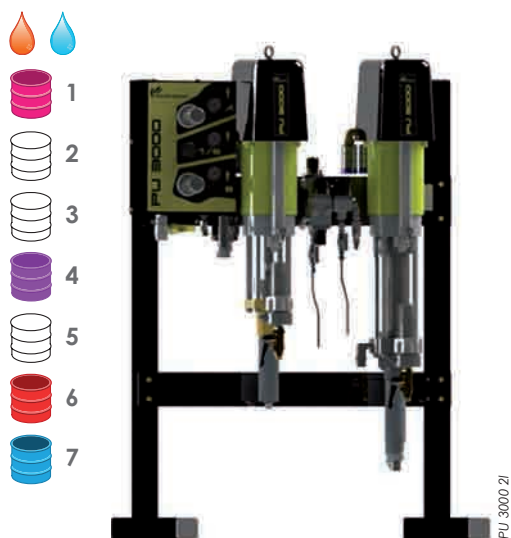

The PU 3000, innovative economical and patented solution, combines electronic control and mechanical metering, ready to use.

The user-friendly control box allows the operator to intuitively learn how to operate the machine.

PATENTED : The innovative pump change-over - FREE PULSE ELECTRONIC technology (FPE) - features a perfectly constant output and a +/- 1% metering accuracy for an outstanding finish and operator peace of mind.

Electronic dosing constantly monitors the actual material consumption of products and calculates the VOC.

The machine can be installed in an ATEX 1 or 2 zone to be in close proximity to the operator. The control box must be installed in safe zone (ATEX Directive).



PU 3000 4l



FEATURES

BENEFITS

Plug & Spray	Quick start-up
Sames Kremlin patent: Free Pulse Electronic Control (FPE)	Constant fluid flowrate
Innovative control system of pump change-over	Unsurpassed +/- 1% mixing accuracy and +/- 1% repeatability
Direct injection in the high performance static mixer	Perfect mixing
Recording of fluid consumptions and VOC Possibility to print records	Fluid and solvent consumptions stored in memory
Automatic component management: base, catalyst and solvent	User friendly
Automatic flushing and material generation	User-friendly and easy programming for the operator
User-friendly control panel	
Preventive maintenance alarm	Safe operation
Continuous ratio checking and alarm	
Low level drum alarm	
Ratio check kit in standart with 2 liters test tube	Visual control of mixing accuracy
Filter and drain assembly in standart	No product loss
Sealing done by a FLOWMAX® bellow on the catalyst side	High reliability
	Total sealing between pump and its environment, ideal to work with moisture-sensitive catalysts
Wide range of ratio from 5 to 160%	Suitable for use on a wide range of markets
Very low flow rate from 10cc	

SPECIFICATIONS

Electrical Power	115/230V - 75W
Maximum air inlet pressure (bar)	6
Fluid viscosity	30 - 20.000cps AIRLESS
Mixing accuracy	+/- 1%
Mixed fluid output	PU 3000 2l: 10cc at 2000 cc / min PU 3000 4l: 50cc at 4000 cc / mm
Mixing ratio	1/1 - 20/1 (100% - 5%)
Wetted parts	Stainless Steel and PEHD

PU 3000 2l and 4l AIRLESS

TECHNICAL CHARACTERISTICS

Description	Pressure ratio	Air motor type	Maximum fluid pressure (bar)
PU 3000 - AIRLESS version	40 / 1	7000	240
PU 3000 - AIRLESS version	53 / 1	5000	350

PU 3000 DIMENSIONS

Description	Height (cm)	Depth (cm)	Width (cm)
AIRLESS version	PU 3000 2l: 130 PU 3000 4l: 150	70	96
Control Box	28.6	14.3	36.7

FITTING

Fitting	Air inlet (valve)	F 3/4" BSP
	Air Outlet	F 1/4" BSP
	Fluid Outlet	F 3/4 JIC

PU 3000 2L PART NUMBERS

Description	Part number
PU 3000 - 124cc - 2l	155.680.102

PU 3000 4L PART NUMBERS

Description	Part number
PU 3000 - 227cc - 4l	155.680.150
PU 3000 - 260cc - 4l Flowmax	155.680.175

PU 3000 OPTION PART NUMBERS

Description	Part number
Spray booth glass mounting kit	155.660.340

PU 3000 FLUSHING PUMPS PART NUMBERS

Description	Suction rod	Purge rod	Air regulator fluid pressure	Filter	Part number
30-C25 flushing pump - PU 3000	● (Ø 16)	-	-	-	151.145.090

CYCLOMIX™ Multi and Multi PH



Supplied without pumps or guns to be ordered separately
Designed to supply one gun only

CYCLOMIX™ electronic dosing to handle several colors: CYCLOMIX™ Multi can handle up to 7 different bases and 3 catalysts.

Modular design CYCLOMIX™ Multi can be positioned in zone 1 or 2 (Directive ATEX). The control cabinet must be installed in safe zone (ATEX Directive).

Programming and use are user-friendly by means of a large touch screen.

For acid catalyst it exists specific references for a CYCLOMIX™ Multi PH.

FEATURES

BENEFITS

Automatic component management: base, catalyst and solvent	Dosing +/- 1% and repeatability +/- 0.5%
Automatic mix material fill	Quick start-up. Minimal material and solvent wastage.
Adaptable programming for each color	Ideal application for each color
Several flushing modes: production cycle, extended production stops, solvent-based materials	Perfect compatibility with production conditions evolutions
Fast mixing ratio accuracy by beakers batch mode	Visual control of mixing accuracy To easily get small quantities of mixed materials for touch-up works
Operating pressure from 2 to 200 bar	AIRLESS spraying technologies
Autowash system	Off-production gun automatic monitoring
Multilingual display and integrated instruction manual	User-friendly and easy programming for the operator
Stainless steel design	Compatible with water-based materials
Numerical interface	Quick link with an on-line automate
Integrated spraying air management	Comfort and safety during color and solvent fill
Pneumatic emergency flushing	Perfect flushing in case of power supply cut-off
Design of the mixing plate	Easy maintenance and spare parts standardization
Robotic interface	Connection with an on-line automate

SPECIFICATIONS

Electrical Power	115 / 230 V - 75 W
Trigger air pressure (bar mini)	4
Product pressure (bar)	2 - 200 bar
Weight (kg)	70
Wetted parts	Stainless steel and PeHD
Mixing ratio	0.6/1 to 20/1 (160% to 5%)
Mixing accuracy	+/- 1%
Maximum number of gun to be fitted	1
Solvent flowrate (m³/h)	100 - 2000 cm³/mn
Mixed fluid output	100 - 2000 cm³/mn
Fluid viscosity	30 - 5000 cps
height (cm)	60 (control cabinet) - 77 (mixing unit)
Width (cm)	60 (control cabinet) - 60 (mixing unit)
Depth (cm)	40 (control cabinet) - 77 (mixing unit)

CYCLOMIX™ Multi and Multi PH

FITTINGS

Description	Fitting
Air supply	F 1/4" BSP
Air outlet	F 1/4" BSP
Fluid supply	M 1/2" JIC
Fluid outlet	F 1/4" BSP

CYCLOMIX™ MULTI PART NUMBERS

Description	Number of bases	Number of catalysts	Part number
CYCLOMIX™ Multi	3	1	155.660.813
CYCLOMIX™ Multi	5	1	155.660.815
CYCLOMIX™ Multi	7	1	155.660.817
CYCLOMIX™ Multi	3	2	155.660.823
CYCLOMIX™ Multi	5	2	155.660.825
CYCLOMIX™ Multi	3	3	155.660.833
CYCLOMIX™ Multi PH	3	1	155.660.513
CYCLOMIX™ Multi PH	5	1	155.660.515
CYCLOMIX™ Multi PH	7	1	155.660.517

OPTION PART NUMBER CYCLOMIX™ MULTI

Description	Part number
Autowash	155.660.300

CYCLOMIX™ Expert

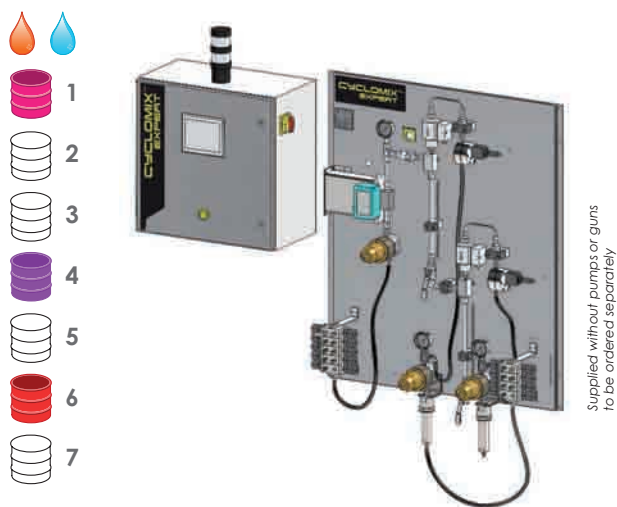

Cyclomix™ EXPERT, industrial and evolutive solution, innovative, guarantees total quality of production.

CYCLOMIX™ Expert can manage a total up to 24 components (bases, catalysts, flushing solvents). It can handle mono, bi or tri-component materials.

The innovative dosing process - ultra fast injection valve - offers unequalled mixing quality and dosing accuracy. The machine can handle 2 working stations at the same time . The machine programming by means of a color screen with ratio/tolerance data assist management - up to 15 languages - has been designed to bring comfort and easiness in the case of product or parameters modifications. The electronic technology brings total monitoring and follow-up of real material consumptions, VOC with recording possibility to ensure tracability.

CYCLOMIX™ Expert can be fitted with different flowmeters technologies (ex: mass flowmeter for difficult paint to handle or water-based materials). The possibility to use Flowmax® technology - developed by Sames Kremlin - bellows instead of traditional packings on the catalyst side brings total reliability for moisture-sensitive isocyanates catalysts.

CYCLOMIX™ Expert is available in AIRLESS versions (up to 200 bars) to meet all market needs, in manual or automatic spraying.

The fluid manifold can be set-up in the spraying area in order to reduce the paint hoses length. Safe zone location (ATEX Directive) for the control cabinet.

Options are available to upgrade the machine depending on each customer configuration.

- Remote color screen control cabinet
- Accessible directly from the working station (spray booth), it allows the operator to manage production, color changes, flushing...

- Automatic Flush box
- Located in the spraying area closed to the painter, it enables the painter to be hands free while system is flushing.

CYCLOMIX™ Expert

FEATURES	BENEFITS
Automatic component management up to 24 components in 1,2, 3 components and solvent	Innumerable possibilities Flexibility when changing materials
Real time display of instant real ratio and flowrate	Continuous process control
No pre-mixing chamber: optimized fluid passages w/o retention zones	Perfect flushing Prevent fluid waste
Stainless steel design	Compatible with water-based materials
Frequency configuration before flushing at the end of potlife	Mixed material and solvent savings Safe operation
Emergency pneumatic manual flushing	Perfect flushing in case of power supply cut-off
batch mode	To easily get small quantities of mixed materials for touch-up works
Adaptable programming for each color	Ideal application for each color
3 data access level upon each operator	Safety use
Assisted data and tolerance product manufacturer specification entry	Quick and easy data entry eliminating any errors
Color man/machine interface	User friendly
Standard monitoring of 2 guns (2 priming - 2 flushing)	Possibility to manage 2 workstations simultaneously (1 or 2 guns or both)
Ratio check	Safe operation Full operator safety
6 different flushing sequences (air-solvent es standard)	Solvent consumption optimization upon recipe
Volume or time flushing	Optimized flushing
Multiples solvent choice for each recipe	
Magnetic injection volume adjustment - electro magnetic valves	Mixing optimization upon ratios Increase of injection frequency
USB data storage	Production Follow-up optimization
Batch number management	
Various Product mesurement technology: mass or gear	Handles a large range of materials

SPECIFICATIONS

Voltage (V)	115 - 230
Number of fluid inlets	24
Trigger air pressure (bar mini)	4
Operating pressure (bar)	5 - 200
Mixing ratio (in standard)	0.6/1 at 30/1
Mixing accuracy	+/- 1%
Mixed fluid output	50 - 6000 cm ³ /mn
Fluid viscosity	30 - 5000 cps
Wetted parts	Stainless steel and PeHD (option 316L)
Width (cm)	100 (3K) - 89 (2K)
Height (cm)	119 (3K) - 91 (2K)
Weight (kg)	48 (2K) - 68 (3K)

CONTROL BOX CHARACTERISTICS

Width (cm)	60
Height (cm)	60
Depth (cm)	40
Weight (kg)	25

CYCLOMIX™ EXPERT PART NUMBER

Description	Part number
CYCLOMIX™ Expert	Please consult us

FITTINGS AND AIR TREATMENT

MALE TO MALE CONNECTION PMAX: 20 BAR

Max Pressure (20 bar)



METRICAL FITTINGS - 20 BAR

Male/Male	M 14 x 125	M 18 x 125
M 14 x 125		050.102.133 050.102.142 ⁽¹⁾
M 18 x 125	050.102.133 050.102.142 ⁽¹⁾	050.102.102

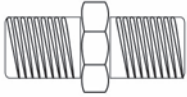

METRICAL ADAPTORS TOWARDS BSP - 20 BAR

Male/Male	M 14 x 125	M 18 x 125	M 26 x 125
G 1/8" (BSP) (5 x 10)	050.102.412		
G 1/4" (BSP) (8 x 13)	050.102.405 050.102.441 ⁽¹⁾	050.102.408 050.102.444 ⁽¹⁾	
G 3/8" (BSP) (12 x 17)	050.102.410	050.102.411 050.102.436 ⁽¹⁾	
G 1/2" (BSP) (15 x 21)	050.102.513	050.102.406 050.102.418 ⁽¹⁾	050.102.402 050.102.437 ⁽¹⁾
G 3/4" (BSP) (20 x 27)		050.102.429	050.102.407

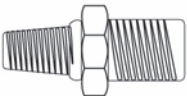

METRICAL ADAPTORS TOWARDS NPT - 20 BAR

Male/Male	M 26 x 125
1/2" NPT	050.102.507

MALE TO MALE CONNECTION PMAX: 60 BAR

FITTINGS BSP (GAZ) - 60 BAR



Male/Male	G 1/8" (5 x 10)	G 1/4" (8 x 13)	G 3/8" (12 x 17)	G 1/2" (15 x 21)	G 3/4" (20 x 27)
G 1/8" (5 x 10)		906.314.207 ⁽¹⁾			
G 1/4" (8 x 13)	906.314.207 ⁽¹⁾	050.102.213 906.314.203 ⁽¹⁾	904.523.003 906.314.204 ⁽¹⁾	050.102.211	
G 3/8" (12 x 17)		904.523.003 906.314.204 ⁽¹⁾	050.102.214 906.314.202 ⁽¹⁾	904.523.006 906.314.205 ⁽¹⁾	
G 1/2" (15 x 21)		050.102.211 050.102.647 ⁽¹⁾	904.523.006 906.314.205 ⁽¹⁾	050.102.212	904.523.012
G 3/4" (20 x 27)				904.523.012	050.102.215

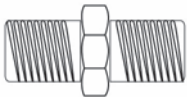

FITTINGS NPT - 60 BAR

Male/Male	1/4" NPT	3/8" NPT
1/4" NPT		905.083.201
3/8" NPT	905.083.201	

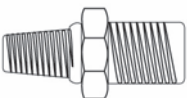

FITTINGS NPS - 60 BAR

Male/Male	1/4" NPS	3/8" NPS
1/4" NPS	050.102.630	050.102.632
3/8" NPS	050.102.632	050.102.631 050.102.652 ⁽¹⁾

ADAPTOR NPS TOWARDS BSP (GAZ) - 60 BAR

Male/Male	1/4" NPS	3/8" NPS
G 1/4" BSP	050.102.624 050.102.644 ⁽¹⁾	050.102.646 ⁽¹⁾
G 3/8" BSP	050.102.627 050.102.647 ⁽¹⁾	050.102.628 050.102.648 ⁽¹⁾
G 1/2" BSP	050.102.633	050.102.629 050.102.649 ⁽¹⁾
G 3/4" BSP		050.102.654 ⁽¹⁾

(1) Stainless steel fittings

FEMALE TO FEMALE CONNECTION

P_{MAX}: 60 BAR

FITTINGS BSP (GAZ) - 60 BAR



Female/Female	G 1/4" (BSP)
G 1/4" (BSP) (8 x 13)	904.593.002
G 3/8" (BSP) (12 x 17)	904.503.003

ADAPTOR BSP (GAZ) TOWARDS METRIC - 20 BAR

Female/Female	G 1/4" (BSP)
M 14 x 125	050.221.401

T FEMALE BSP (GAZ) - 60 BAR

Description	Part number
Fittings 3 x G 1/4" (BSP) (8 x 13)	904.303.002
Fittings 3 x G 3/8" (BSP) (12 x 17)	904.303.003
Fittings 3 x G 1/2" (BSP) (15 x 21)	904.303.004
Fittings 3 x G 3/4" (BSP) (20 x 27)	904.303.006

T FEMALE NPT - 60 BAR

Description	Part number
Fittings 3 x 1/4" NPT	905.083.301

MALE TO FEMALE CONNECTION

P_{MAX}: 20 - 60 BAR

ADAPTOR NPS TOWARDS JIC, NPS AND METRIC - 20 BAR

Male/Female	1/4" NPS	3/8" NPS
1/2" JIC	150.123.305 ⁽¹⁾	050.103.537 ⁽¹⁾
1/4" NPS	-	050.103.534 ⁽¹⁾
M 14 x 125	-	050.103.523 ⁽¹⁾

⁽¹⁾ Stainless steel fittings

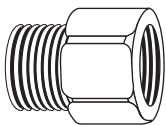

FITTINGS BSP (GAZ) - 60 BAR

Male/Female	G 1/4" (8 x 13)	G 3/8" (12 x 17)	G 3/4" (20 x 27)
G 1/4" (8 x 13)	050.123.205	904.533.003	-
G 3/8" (12 x 17)	904.513.003	-	-
G 1/2" (15 x 21)	904.513.005	-	904.533.009
G 3/4" (20 x 27)	904.513.011	904.513.012	-
G 1" (26 x 34)	-	-	904.513.012

FITTINGS METRIC - 20 BAR

Male/Female	M 14 x 125	M 18 x 125	M 26 x 125
M 14 x 125	-	050.123.109	-
M 18 x 125	050.123.101	-	050.123.110
M 26 x 125	-	050.123.106	-

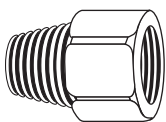

ADAPTOR METRIC TOWARDS NPS - 20 BAR

Male/Female	M 14 x 125	M 18 x 125
1/4" NPS	050.123.535	050.123.526
3/8" NPS	-	050.123.610

ADAPTOR JIC TOWARDS METRIC - 20 BAR

Male/Female	M 14 x 125	M 18 x 125
1/2" JIC	050.230.619	050.230.620

ADAPTOR JIC TOWARDS NPS AND METRIC - 20 BAR

Male/Female	1/2" JIC
1/4" NPS	050.123.304
3/8" NPS	050.123.533
M 18 x 125	050.123.521

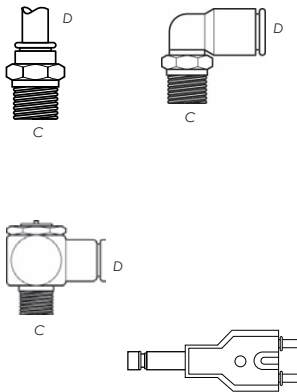

QUICK FITTINGS FOR SMALL DIAMETER SPECIAL AIR HOSES
CONFIGURATION FITTINGS

C	D	Straight	Right angle 90°	T- piece
G 1/8" (5 x 10) BSP	4	905.120.907	905.120.926	-
G 1/8" (5 x 10) BSP	8	-	905.120.934	-
G 1/4" (8 x 13) BSP	4	-	905.120.927	-
G 1/4" (8 x 13) BSP	6	905.120.965	905.120.905	-
G 1/4" (8 x 13) BSP	8	905.120.904	905.120.912	905.120.920
6 x 8 hose T	T for hose 4 x 6	2,7 x 4 Hose T- piece	4 x 6/2,7 x 4 Reduction T- piece	
905.120.915	905.120.903	905.120.957	905.120.928	

ISO 6150 QUICK-FIT FITTINGS (MAXIMUM PRESSURE: 10 BAR)

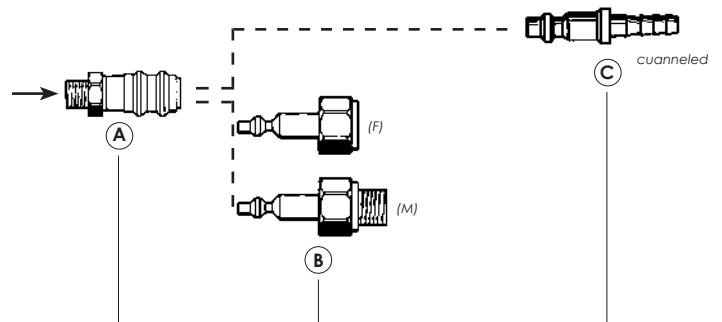

QUICK FITTINGS

Type	Complete assembly A and B	Part A with built-in chutter valve	Part B	Part C for rubber hose Ø 7	Part C for rubber hose Ø 10
Ø5 (14x125)	905.030.405	905.030.102	905.030.406 (F)	905.030.203	905.030.204
Ø5 (1/4" BSP)	-	-	905.030.804 (M)	-	-
Ø5 (1/4" BSP)	-	-	905.030.803 (F)	-	-
Ø5 (1/4" NPS)	905.030.105	905.030.104	905.030.106 (F)	-	-
Holding collar	-	-	-	906.311.224	906.311.226

COMPLETE QUICK DISCONNECT 1/4" NPS FOR AIR HOSE

Description	Part number
Air inlet quick-disconnect fitting	905.030.105

QUICK FITTINGS FOR Ø 8 HOSE

Type	Part A with on/off press button for hose Ø 8	Part C for hose Ø 8
Ø 5	905.030.801	905.030.802

FITTINGS FOR LOW PRESSURE POLYAMIDE HOSES

FITTINGS CONFIGURATION

Thread size	Material	Hoses Inter. Diameter (mm)	Part number
M 3/8" NPS	Nickel plated brass	6.35 - 1/4	050.231.350
M 1/4" NPS	Nickel plated brass	6.35 - 1/4	050.231.450
M 3/8" NPS	Nickel plated brass	9.52 - 3/8	905.140.103

CRIMP FITTINGS FOR LOW PRESSURE AIR HOSES

FITTINGS CONFIGURATION



Material	Thread size	Hoses Inter. Diameter (mm)	Part number	Collar
Straight fittings				
Nickel plated brass	1/4" NPS	7	050.231.705	906.311.224
Nickel plated brass	1/4" NPS	8	050.231.707	906.311.224
Nickel plated brass	1/4" NPS	10	050.231.702	906.311.226
Nickel plated brass	3/8" NPS	7	050.231.716	906.311.224
Nickel plated brass	3/8" NPS	10	050.231.706	906.311.226
Nickel plated brass	3/8" NPS	16	050.231.701	906.311.232
Stainless steel	M 14 x 125	5	050.230.610	906.311.208
Nickel plated brass	M 14 x 125	10	050.230.602	906.311.226
Nickel plated brass	M 18 x 125	7	050.230.616	906.311.224
Stainless steel	M 18 x 125	10	050.230.614	906.311.226
Nickel plated brass	M 18 x 125	10	050.230.606	906.311.226
Nickel plated brass	M 18 x 125	16	050.230.601	906.311.232
Nickel plated brass	M 26 x 125	16	050.230.603	906.311.232
Elbow fittings				
Nickel plated brass	M 18 x 125	10	050.250.202	906.311.226
Junction fittings without thread				
Nickel plated brass	-	7	050.190.403	906.311.224
Nickel plated brass	-	10	050.190.401	906.311.226

PLUGS PMAX: 20 - 60 BAR

PLUGS CONFIGURATION

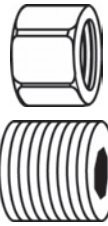

Description	Part number
Male	Male
G 1/8" (5 x 10)	906.333.106
G 1/4" (8 x 13)	906.333.102
G 3/8" (12 x 17)	906.333.104
G 1/2" (15 x 21)	906.333.103
G 3/4" (20 x 27)	906.333.105

MALE TO MALE FITTINGS (PROTECTIVE COATED STEEL) PMAX: 400 BAR

FITTINGS CONFIGURATION



Male/Male	1/2" JIC	3/4" JIC	7/8" JIC
1/2" JIC	050.102.301	905.160.201	550.914
3/4" JIC	905.160.201	905.160.202 - - 550.545	550.915
7/8" JIC	550.914	550.915	-

MALE TO FEMALE FITTINGS (STAINLESS STEEL) PMAX: 360 BAR

FITTINGS CONFIGURATION



Male/Female	1/2" JIC
3/4" JIC	050.123.301

**MALE TO MALE ADAPTERS: PMAX: 360 BAR
PROTECTED STEEL FITTINGS CONFIGURATION**



Male/Male	1/2" JIC	3/4" JIC
1/4" NPT	000.972.025	905.160.212
3/8" NPT	000.972.028	905.160.206
1/2" NPT	-	905.160.204
3/4" NPT	-	905.160.203

STAINLESS STEEL FITTINGS CONFIGURATION

Male/Male	1/2" JIC	3/4" JIC
1/8" NPT	905.210.501	-
1/4" NPT	905.210.502	905.210.512
3/8" NPT	905.210.503	905.210.513
1/2" NPT	905.210.504	905.210.514
3/4" NPT	-	905.210.515

PROTECTED STEEL FITTING CONFIGURATION

Male/Male	1/2" JIC	3/4" JIC	7/16" JIC	7/8" JIC	1 1/16" JIC	1 5/16" JIC
1/8" G co	550.548	-	550.920	-	-	-
1/4" G co	550.542	-	-	-	-	-
3/8" G co	550.549	550.679	-	550.609	-	-
1/2" G co	-	550.544	-	550.540	550.903	-
3/4" G co	550.905	-	-	550.823	550.864	550.932
1" G co	-	-	-	-	550.900	550.901

NICKEL-COATED FITTINGS CONFIGURATION

Male/Male	1/2" JIC	3/4" JIC
3/8" NPT	050.470.202	905.160.103

**MALE TO FEMALE ELBOW FITTINGS
PMAX: 360 BAR**



FITTINGS CONFIGURATION

Male/Female (free nut)	1/2" JIC
1/2" JIC	905.160.101

**MALE TO MALE ELBOW FITTINGS (STAINLESS STEEL)
PMAX: 360 BAR**



FITTINGS CONFIGURATION

Male/Male	1/2" JIC	3/4" JIC
1/4" NPT	905.210.602	905.210.612
3/8" NPT	905.210.603	-
1/2" NPT	905.210.604	-
3/4" NPT	-	905.210.615

**MALE TO MALE ELBOW FITTINGS (PROTECTIVE COATED STEEL)
PMAX: 360 BAR**

NPT FITTINGS CONFIGURATION

Male/Male	1/2" JIC	3/4" JIC
1/8" NPT	905.160.105	-
1/4" NPT	-	905.160.102

G CO FITTING CONFIGURATION

Male/Male	1/2" JIC	3/4" JIC
1/4" G co	550.596	550.923
3/8" G co	551.819	-

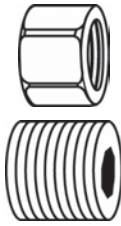

PLUGS PMAX: 360 BAR

PLUGS CONFIGURATION

Description	Part number
Female 1/2" JIC	906.333.301
Male 1/8" NPT	906.333.108

LOW PRESSURE VALVES

3 WAYS VALVE PART NUMBERS

Description	Part number
3 x 1/4" BSP (female)	903.090.804
3 x 1/4" BSP (female) (stainless steel)	903.090.805

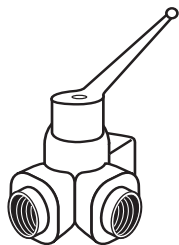

2 WAYS MALE/MALE VALVE PART NUMBERS

Description	Input	Output	Part number
Ball valve	(M) G 1/4" (8 x 13)	(M) M 14 x 125	050.070.205
Inlet (male) G 3/8" (12 x 17) outlet (male) M 14 x 125	(M) G 3/8" (12 x 17)	(M) M 1/4" NPS	050.070.211
Inlet (male) G 1/2" (15 x 21) outlet (male) M 18 x 125	(M) G 1/2" (15 x 21)	(M) M 18 x 125	050.070.204
Inlet (male) G 1/2" (15 x 21) outlet (male) de0101G 1/2 (15 x 21)	(M) G 1/2" (15 x 21)	(M) M 18 x 125	050.070.201
Inlet (male) G 3/8" (12 x 17) outlet (male) M 18 x 125	(M) G 3/8" (12 x 17)	(M) M 18 x 125	050.070.212

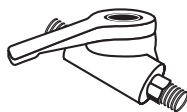

2 WAYS FEMALE/FEMALE VALVE PART NUMBERS

Description	Input	Output	Part number
Valve	(F) 1/4" BSP (8 x 13)	(F) 1/4" BSP (8 x 13)	903.090.806
Valve	(F) 3/8" BSP (12 x 17)	(F) 3/8" BSP (12 x 17)	903.090.206

AIR BLEEDING VALVES

AIR BLEEDING VALVE PART NUMBER

Description	Part number
Inlet thread (male) G 1/4" (8 x 13)	903.093.302

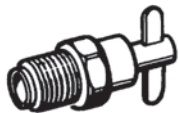
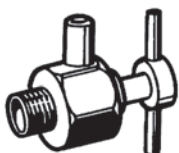

NEEDLE VALVES

2 WAYS VALVE PART NUMBERS

Description	Input	Output	Part number
Female/Male	M 14 x 125	M 14 x 125	050.070.179
Male/Male	G 1/4" (8 x 13)	M 14 x 125	050.070.101



3 WAYS VALVE PART NUMBERS

Description	Part number
Female/male/male M 14 x 125	050.070.401





HIGH PRESSURE FLUID VALVES

PART NUMBER

Description	Input	Output	Maximum fluid pressure (bar)	Part number
Female/Female	G 3/8" (12 x 17)	G 3/8" (12 x 17)	250 bar	000.750.040

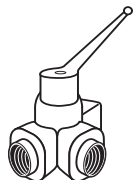

3 WAYS VALVE - 350 BAR - PART NUMBERS

Description	Part number
3 x 1/4" BSP (female) (stainless steel)	903.091.006

AIR LINE OUTPUT CONTROL VALVES

VALVE PART NUMBERS



Description	Input	Output	Part number
Female/Male	G 1/4" (8 x 13)	G 1/8" (8 x 13)	050.070.190
Female/Male	M 14 x 125	M 14 x 125	050.070.179

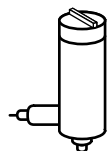

BLEEDING VALVES

BLEEDING VALVES PART NUMBERS

Description	Input	Output	Maximum fluid pressure (bar)	Part number
Male/Male	G 1/4" (8 x 13)	M 18 x 125	400	000.760.000

FITTINGS - GENERAL INFORMATION

DETAILS

Denomination	Fitting characteristics	Geographical area	Max. operating pressure (bar)
M	cylindrical metric	France	20
G = BSP	conical gas (or cylindrical)	Europe - Asia	60
NPT	conical	USA - Asia	60
NPS	cylindrical	USA - Asia	60
JIC	cylindrical angle 74°	Universal	360



REGULATORS

1/4" (with grey or red knob) , 1/2" and 3/4" (with red ring) regulators are used on the compressed air lines.

CHARACTERISTICS

Regulator	1/4"	1/2"	3/4"
Max. inlet pressure (bar)	9	20	21
Max. output (m ³ /h)	25	210	360

CONFIGURATION

Description	Pressure (bar)	Type	Part number
Red knob regulator	3,5	1/4"	016.240.000
Grey knob regulator	3,5	1/4"	016.380.000
2 regulators 1/4" with isolating valves 2 manometers, 1 inlet valve - 1 outlet valve M 1/4" NPS	3,5 & 9	1/4"	019.400.000
Grey knob regulator	5,5	1/4"	016.390.000
Red knob regulator	5,5	1/4"	016.370.000
Regulator with pressure gauge inlet fitting 1/4" - outlet fitting M1/4" NPS	5,5	1/4"	019.720.000
Grey knob regulator	9	1/4"	016.360.000
Phosphor knob regulator	9	1/4"	016.365.500
Bare regulator	4	1/2"	016.200.000
Bare regulator	9	1/2"	016.280.000
Equipped regulator with pressure gauge and wall bracket	10	1/2"	019.780.100
2 regulators (1/4" + 1/2") with isolating valves 2 manometers, 1 inlet valve - 2 outlet valves M 1/4" NPS	9	1/4"	019.390.000
Red ring regulator	10	1/2"	016.470.000
Red ring regulator	10	3/4"	016.480.000
Wall bracket	-		016.180.010

DE 37 PURIFIER-REGULATOR WITH FILTER CARTRIDGES

Usually fitted in the paint spray booths. Its twin-body construction ensures completely water and oil free.

Technical characteristics:

- Maximum operating air output: 37 m³/h
- Maximum operating air pressure: 10 bar
- Height: 290 mm
- Air inlet opening: F1/4"G

Standard equipment:

- One regulated pressure gauge
- One F1/4"G
- One tap valve F1/4"G
- Two air outlet taps: M 1/4" NPS



SPECIFICATIONS

Air output (m ³ /h)	37
Maximum fluid pressure (bar)	10
Height (cm)	29
Fitting	Air Inlet F8 x 13G
Set-up	1 regulated pressure gauge 1 valve F 1/4" G 1 ball valve F 1/4" G 2 air outlet taps M 1/4" NPS

PART NUMBERS

Description	Part number
Purifier with DE 37 regulator	015.240.000
Blue cartridge for water	015.230.500
Red cartridge for oil	015.230.200

REGULATORS, FILTERS AND LUBRICATORS

Regulators with pressure gauges, filters and lubricators with polycarbon reservoirs are all modular, allowing you to put together the best air treatment equipment for your needs.



Part 1

- Filter with trunnion deflector, transparent polycarbon reservoirs (heat resistant up to 50°C), manual bleed and a bronze filter capable of holding all particles larger than 5 microns.
- Regulator with pressure gauge: self-regulating and vibration free, pressure gauges from 0 to 12 bar/180 psi, equipped with automatic decompression system
- Lubricator with transparent polycarbon lid (heat resistant up to 50°C), flush adjustment screw; it lubricates by fine vaporisation
- Maximum operating pressure: 12 bar/180 psi

REGULATORS, FILTERS, LUBRICATORS CONFIGURATION (PART 1)

Type	Inlet diameter	Outlet diameter	Output at 9 bar (l/mn)	Part number
Regulator with gauge				
M 150/2	1/4"	1/4"	1000	004.601.100
M 250/3	1/2"	1/2"	5250	004.601.300
Filter with polycarbonate tank				
M 100/2	1/4"	1/4"	1760	004.603.100
M 200/2	3/8"	3/8"	7000	004.603.200
Lubricator with polycarbonate tank				
M 110/2	1/4"	1/4"	2500	004.604.100
M 210/3	1/2"	1/2"	5250	004.604.300

REGULATORS, FILTERS, LUBRICATORS CONFIGURATION (PART 2)

Type	Inlet diameter	Outlet diameter	Part number
Bare 3/4" regulator	3/4" G	3/4" G	91.530
Bare 3/4" regulator + filter	3/4" G	3/4" G	91.532
3/4" regulator with manometer Ø 62 mm	3/4" G	3/4" G	91.531
3/4" regulator with manometer Ø 62 mm + filter	3/4" G	3/4" G	91.533
Filter 3/4" regulator	3/4" G	3/4" G	91.534
3/4" regulator, filter, lubricator, adjusting valve on wall base	1/2" G	1/2" G	91.398
Bare 1/4" regulator	1/4" G	1/4" G	91.551
Bare 1/4" regulator + filter	1/4" G	1/4" G	91.555
1/4" regulator with manometer Ø 62 mm	1/4" G	1/4" G	91.552
1/4" regulator with manometer Ø 62 mm + filter	1/4" G	1/4" G	91.558
Bare 1/4" filter	1/4" G	1/4" G	91.553
Ø 62 mm manometer side output - 0 to 10 bar	1/8" G	-	151.080.094
Ø 62 mm manometer rear output - 0 to 10 bar	1/8" G	-	151.080.091
Wall bracket for 3/4" regulators	-	-	210.006
Reattaching ring for regulator (mounting on control panel)	-	-	91.540
Locking mechanism for regulators	-	-	91.545
Adjusting valve with lock	-	-	91.544
Lubrication oil (2 liters)	-	-	149.990.017



Part 2



ACCESSORIES

Allow the easy assembly and fitting of regulators, lubricators and filters to provide the ideal system.

PART NUMBERS

Description	Part number
Regulator support bracket F 171/1 for 1/8" and 1/4"	004.601.002
Regulator support bracket F 176/1 for 3/8" and 1/2"	004.601.201



PRESSURE GAUGES

Built to last in metal with glass lenses, they are completely impact and solvent resistant.

CONFIGURATION

Description	Internal diameter (mm)	Pressure range (bar)	Part number
Pressure gauge - central inlet	40	0 - 6	910.011.205
Pressure gauge - central inlet	40	0 - 2,5	910.011.208
Pressure gauge - central inlet	50	0 - 6	910.011.403
Pressure gauge - side inlet	50	0 - 10	910.011.402
Pressure gauge - side inlet	50	0 - 4	910.011.404

CHOOSING A PUMP

To optimize

- For the best pump capacity, first work out the output you are going to require. This will include the sprayguns themselves, and any circulation you plan to have within this system. Once you have this figure, multiply by 1.2, and then choose the pump of which output at 30 cycles per minute is the nearest.
- The compression ratio you will need is defined by the pressure losses due to the length and diameter of the hosing of your system. To calculate these pressure losses, see page 81.

Example

let say you want to feed 3 conventional guns with an output of 500 cc/mn each, plus a circulation of 0,5 l/mn.

The total output will thus be 2 l/mn. The optimal pump capacity would be: $(2\ 000 \times 1,2) \div 30 = 80$ cc/cycle.

The best-suited pumps will be:

- » the PMP 150 (output of 100 cc/cycle and pressure ratio of 1:1) for low viscosity materials and a small circulating (pressure loss < 3 bar).
- » the 02.75 (output of 85 cc/cycle and pressure ratio of 2:1) for thicker materials and a normal circulating (pressure loss < 6 bar).
- » the 04.120 (output of 240 cc/cycle and pressure ratio 4:1) for large pressure loss in circulating (up to 15 bar).

PUMP MATERIAL FEEDING

To guarantee the right delivery of product, we offer the following range of equipment for various product viscosity:

- » 0 - 300 cps
 - suction rod.
- » 300 to 8 000 cps
 - top outlet pressure pots,
 - pumps (gravity or suction rod),
 - pump with base intake valve.
- » 8 000 to 15 000 cps
 - bottom outlet pressure pots,
 - pumps with suction rods,
 - compressor.
- » 15 000 to 30 000 cps
 - no more pressure pot,
 - no more suction rod,
 - submerged hydraulic pump,
 - compressor,
 - pump with single action elevator.
- » 30 000 à 1 000 000 cps and +
 - pumps with peak feeder and double action elevator.

PRACTICAL PAGES

FILTRATION EQUIVALENCE

Mesh (number of holes in 25,4 mm)	Micron	N° filtre (mesh opening in µm)
10	1480	–
16	975	–
20	750	30
25	630	25
30	500	20
40	375	–
45	360	15
50	300	12
60	238	–
70	210	8
80	175	6
100	149	–
140	100	4
170	90	3
200	74	–
250	60	–
270	50	2
325	40	1
400	35	–

PRESSURE LOSS IN FLUID HOSES

Pressure drop is the resistance that prevents material from moving forward in the pipe. Two pipe variables influence this resistance: the (inside/internal) diameter and the pipe length. The pump will generate a pressure, strong enough to move the fluid material through the pipe (or hose) to the material pipe outlet. This pressure must be enough to overcome the original pressure drop. While it is hard to reduce the pipe length, it is relatively easy to select an appropriate internal pipe diameter.

PRESSURE DROP CALCULATION

$$\text{Pressure loss (bar/m)} = \frac{6.9 \times \text{Flow (l/min)} \times \text{Viscosity (cps)}}{D^4 \text{ (int dia in mm)}}$$

$$\text{Pressure loss (psi/Ft)} = \frac{2.73 \times \text{Flow (gpm)} \times \text{Viscosity (cps)}}{D^4 \text{ (int dia in inches)}}$$

FLOW RATE CALCULATION

$$\text{Flow (l/min)} = \frac{\text{Pressure loss (bar/m)} \times D^4 \text{ (int dia in mm)}}{6.9 \times \text{Viscosity (cps)}}$$

$$\text{Flow (gpm)} = \frac{\text{Pressure loss (psi/Ft)} \times D^4 \text{ (int dia in inches)}}{2.73 \times \text{Viscosity (cps)}}$$

PIPE DIAMETER CALCULATION

$$\text{Interior Dia (mm)} = \sqrt[4]{\frac{6.9 \times \text{Flow (l/min)} \times \text{Viscosity (cps)}}{\text{Pressure Loss (bar/m)}}}$$

$$\text{Interior Dia (in)} = \sqrt[4]{\frac{2.73 \times \text{Flow (gpm)} \times \text{Viscosity (cps)}}{\text{Pressure loss (psi/Ft)}}}$$

PRESSURE LOSS IN AIR HOSES

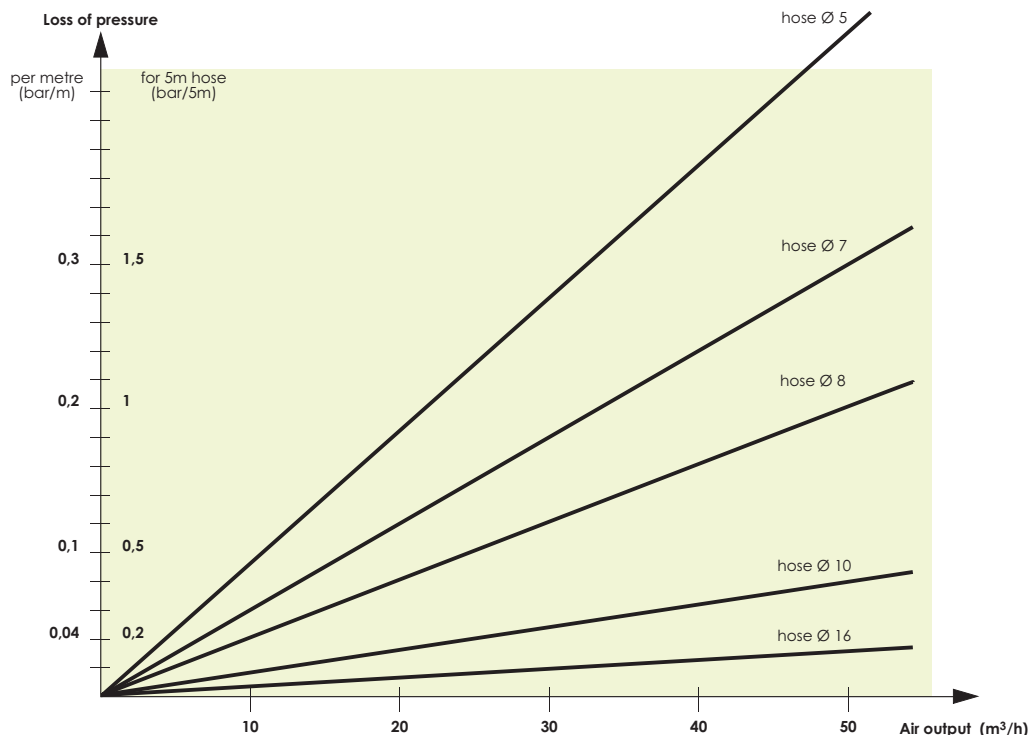

ELECTROSTATIC SPRAYING : SUITABILITY OF THE EQUIPMENT DEPENDING ON THE RESISTIVITY OF THE PAINTS

- The wrap-around affect is optimized with paints of resistivity range of 5 - 50 MΩ.cm..
- Specific hoses allows for wrap-around effects for resistivity range higher than 2MΩcm.
- For water-based materials (0 MΩ.cm), a special ISObubble enclosure allows to benefit from all the advantages of electrostatic spraying in complete safety.

LIST SHOWING THE COMPRESSED AIR CONSUMPTION OF NORMAL AIR TOOLS

We generally multiply the instant consumption by a coefficient of 0,5 to 0,9 to allow for the time the tool is not in use.

The average air volume delivered by a compressor of 1 CV is of 8 m³/h.

Tool	Consumption	
	l/mn	m³/h
Projection equipment	800 at 1 800	48 at 108
Riveter	450 at 1 500	27 at 90
Pneumatic drill	600 at 1 200	36 at 72
Linisher Ø 230	1 200 at 4 000	72 at 240
Drill 13 mm	600	36
Rotating sander	200 at 400	12 at 24

Tool	Consumption	
	l/mn	m³/h
Conventional gun	160 at 500	10 at 30
AIRMIX® gun	67 at 134	4 at 8
Pumps	160 at 1 350	10 at 80
Blower	200 at 400	12 at 24
Screwdriver	200 at 400	12 at 24

Calculate exactly the maximum air consumption of pump in l/mn : Q

The formula is :

$$Q = 1.2 \times \text{fluid output} \times \text{pressure ratio} \times (\text{air motor feeding pressure in bar} + 1 \text{ bar for atmosphere})$$

Example for a pump 16.120 : $Q = 1.2 \times 4,8 \times 16 \times (6 + 1) = 645.12 \text{ l/mn}$ or $(645.12 \times 60) : 1000 = 38.7 \text{ m}^3/\text{h}$

PRACTICAL PAGES

VALUE OF « PH »

The pH value of a liquid or a solution quantifies its concentration of hydrogen ions and tells us the extent to which it is acidic or alkaline. The PH value dictates the best materials to be used in construction of major paint handling and spraying equipment.

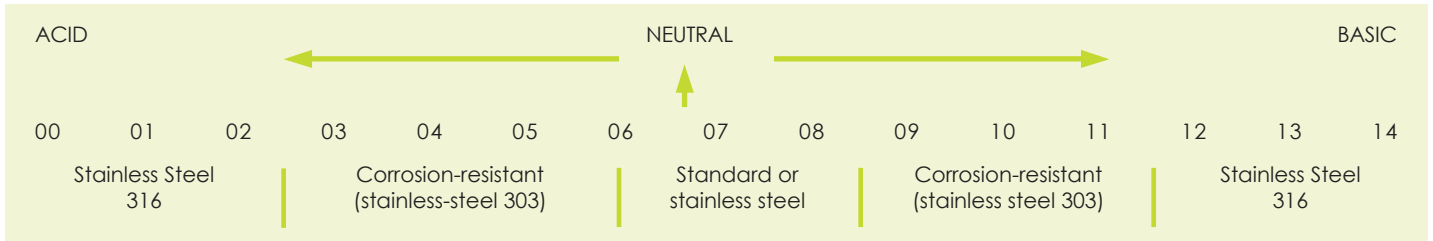

PRACTICAL INFORMATION: METRIC - ENGLISH CONVERSION

CONVERT FROM	TO	MULTIPLY BY
Centimeters	feet	0.03280
Centimeters	inches	0.3937
Centimeters/min.	feet/min.	1.9684
Centimeters/sec.	feet/sec.	0.03281
Cubic centimeters.	cubic feet	3.5314 x 10 ⁻⁵

CONVERT FROM	TO	MULTIPLY BY
Cubic centimeters	ounces	0.033
Cubic centimeters	liquid gallons	0.0002642
Cubic feet	liquid gallons	7.4805
Cubic feet	cubic inches	1.728
Cubic feet/min.	gallons/min.	7.4805

CONVERT FROM	TO	MULTIPLY BY
Cubic inches	gallons	0.004329
Cubic inches	cubic centimeters	16.387
Cubic inches	cubic feet	0.0005787
Cubic meters	liquid U.S. gallons	264.17
Cubic meters	cubic centimeters	1 x 10 ⁶

CONVERT FROM	TO	MULTIPLY BY
Cubic meters	cubic feet	35.31
Cubic meters	cubic inches	61,023.38
Feet	centimeters	30.48006
Feet	meters	0.3048006
Feet of water	atmosphère	0.02949

CONVERT FROM	TO	MULTIPLY BY
Feet of water	psi	0.443
Feet/hour	miles/hour	0.00018933
Feet/min.	meters/min.	0.3048
Feet/min.	miles/hour	0.01136
Feet/sec.	miles/hour	0.681818

CONVERT FROM	TO	MULTIPLY BY
Gallons	cubic cm	3 785.43
Gallons	cubic inches	231
Gallons	imperial gallons	0,83268
Gallons	cubic feet	0,13368
Gallons/min.	cubic feet/min.	0,13368

CONVERT FROM	TO	MULTIPLY BY
Inches	feet	0,083333
Inches	meters	0,254
Inches	millimeters	25,40005
Inches	mils	1 000
Kilograms	pounds	2,2046

CONVERT FROM	TO	MULTIPLY BY
Kilogrammes/cm ²	psi	14,2233
Kilogrammes/mm ²	psi	1 422,33
Liters	gallons	0,264178
Meters	feet	3,2808
Meters	inches	39,37

CONVERT FROM	TO	MULTIPLY BY
Poise	centipoise	100,0
Pints of water	gallons	0,11985
PSI	atmosphère (bar)	0,06804
Inches ²	cm ²	6,4516
Inches ²	feet ²	0,006944
Inches ²	mm ²	645,163
Millimètres ²	inches ²	0,0015499
daN	Kilograms	1.0

- » For the diameter of a circle, multiply the circumference by 0.31831.
- » For the circumference of a circle, multiply the diameter by 3.1416.
- » For the surface of a circle, multiply the diameter² by 0.7854.
- » For the surface of a sphere, multiply the diameter² by 3.1416.
- » To find the side of a square that has the same surface area of a circle, multiply the diameter by 0.8862.
- » To find the number of cubic inches in a sphere, multiply the diameter by 0.5236.
- » To find the number of gallons inside a pipe or cylinder, divide the volume in liters by 231.
- » To find the cubic volume of a cylinder or pipe, multiply the section area by the length.

PRACTICAL INFORMATION

CHEMICAL COMPATIBILITY CHARTS

MATERIAL IN CONTACT (WETTED PARTS)

	Carbon steel	Aluminium	Brass	Stainless steel	Nylon	Nitrile	Vitton	Leather	P.U.
Butyl acetate	👍👍👍	👍👍👍	👍👍👍	👍👍👍	👍👍👍	N	N		N
Ethyl acetate	👍👍	👍👍	👍👍	👍👍	👍👍👍	N			
Acetaldehyde	👍👍👍	👍👍👍	👍👍👍	👍👍👍	👍👍👍	N	N	👍👍	N
Amonium acetate				👍👍👍					
Acedic acid	👍👍👍			👍👍👍	👍👍👍	N	N	N	N
Boric acid	👍👍👍	👍👍👍		👍👍👍	👍👍👍		👍👍👍	👍👍👍	👍👍👍
Hydrobromic acid					👍👍👍	N	👍👍👍		
Chloridic acid	N	N		N	👍👍👍	N	👍👍👍		
Chromic acid	N	N	N	👍	👍👍👍	N			
Citric acid				👍👍👍	👍👍👍		👍👍👍		
Fluorohydric acid						N	👍👍👍		
Fluosilicic acid			👍👍👍		👍👍👍	N	N		
Formic acid	N	👍👍	N	👍	👍👍👍	N	👍		
Nitric acid	N	N	N	👍👍👍	👍👍👍	N	👍👍👍		
Oxylic acid	N	N	N	N	👍👍👍		👍👍👍	👍👍👍	👍👍👍
Phosphoric acid	N	N		👍👍👍	👍👍👍	N	👍👍👍		
Ethylalcohol						👍👍👍	N		
Methylalcohol	👍👍👍						N	👍👍👍	N
Acetic aldehyde	👍👍👍	👍👍👍		👍👍👍	👍👍👍	N	N		N
Formic aldehyde	N	👍👍	N	N	👍👍👍	N	👍👍👍		N
Sodium alginate					👍👍👍		N		
Starch						👍👍👍	👍👍👍		
Amines					👍👍👍	N	N	N	
Acetone	👍👍👍	👍👍👍		👍👍	👍👍👍	N	N		N
Liquid ammonia	👍👍👍	👍👍👍		👍👍👍	👍👍	👍👍	N	N	
Benzene	👍👍👍	👍👍👍	👍👍👍	👍👍👍	👍👍👍	N	👍👍👍	👍👍	👍
Sodium bicarbonate		N	N	👍👍👍	👍👍👍	👍👍👍	👍👍👍		
Chlorine dioxide						N	👍👍👍		
Sodium bisulphate	N	N		N	👍👍👍	N	👍👍👍		
Brominate						N			
Calcium carbonate	👍👍👍			👍👍👍	👍👍👍	👍👍👍	👍👍👍	👍👍👍	
Sodium carbonate					👍👍👍		👍👍👍		
Chlorinate, gas						👍👍👍	👍👍👍		
Sodium chlorite							👍👍👍		👍👍👍
Aluminum chlorosulfate					👍👍👍	👍👍👍	👍👍👍	👍👍👍	
Calcium chloride	👍👍👍			👍👍👍	👍👍👍		👍👍👍		👍👍👍
Magnesium chloride	👍👍	N		N	👍👍👍	👍👍👍	👍👍👍	👍👍👍	👍👍👍
Potassium chloride	N	N		👍👍	👍👍👍	👍👍👍	👍👍👍	👍👍👍	👍👍👍
Sodium chloride					👍👍👍	👍👍👍	👍👍👍		👍👍👍
Zinc chloride	N	N		N	👍👍👍	👍👍👍	👍👍👍		👍👍👍
Ferrous chloride	N	N	N	N	👍👍👍		👍👍👍		
Ferric chloride	N	N	N	N	👍👍👍		👍👍👍		👍👍👍
Cyclohexane	👍👍👍	👍👍👍	👍👍👍	👍👍👍	👍👍👍	👍👍👍	👍👍👍		
Chlorobenzene	👍👍👍			👍👍👍	👍	N	👍👍👍		N
Ethylene chloride		👍👍			👍👍	N	👍👍		N
Methylene chloride	👍👍	N	👍👍	👍👍	N	N	👍👍		N
Diatoms						👍👍👍	👍👍👍		
Dichloroethylene					👍👍👍				
Diethylene glycol	👍👍👍	👍👍		👍👍👍	👍👍👍	👍👍👍	👍👍👍		N
Bleach	N	👍👍		👍👍👍	👍👍👍				👍
Distilled water	N	👍👍👍	👍👍👍	👍👍👍	👍👍👍		👍👍👍	👍👍👍	👍👍👍
Oxygenated water	N		N	👍👍	N		👍👍		👍👍👍
EDTA						👍👍👍	N		

PRACTICAL INFORMATION

CHEMICAL COMPATIBILITY CHARTS

MATERIAL IN CONTACT (WETTED PARTS)

	Carbon steel	Aluminium	Brass	Stainless steel	Nylon	Nitrile	Vitton	Leather	P.U.
Fertilizer						👍👍👍	N		
Ethanol					👍👍👍	👍👍👍	N		
Ethyl ether	👍👍	👍👍		👍👍	👍👍👍	N	N		👍
Ethylene glycol	👍👍	👍👍	👍👍👍	👍👍	👍👍👍	👍👍👍	👍👍👍		N
Ethyl-mercaptan						N	👍👍👍		
Fuel						N	👍👍👍		
Fluosilicate			👍👍👍		👍👍👍	👍👍👍	👍👍👍		
Formaldehyde	N	👍👍		N	👍👍	👍👍👍	👍👍👍		N
Glycol	👍👍	👍👍		👍👍	👍👍👍	👍👍👍	👍👍👍		N
Gelatine	N	👍👍		👍👍👍	👍👍👍	N	N		N
Sodium hydroxide					👍👍👍	N	N		N
Ammonium hydroxide				👍👍👍	👍👍👍	N	N	👍👍	N
Potassium hydroxide	👍	N		👍👍	👍👍👍	N	N		N
Calcium hypochlorite				👍	👍👍👍	N	👍👍👍	N	
Sodium hypochlorite					👍👍👍	N	👍👍👍		N
Sodium hyposulfite					👍👍👍	N	👍👍👍		
Fruit juice						👍👍👍	👍👍👍		
Methanol	N	👍👍👍		👍👍👍			N		👍
Morpholine	👍👍👍	👍👍👍				N	N		
Methylethylcetone	👍👍👍	👍👍		👍👍👍	👍👍👍	N	N		N
Sodium nitrite					N	N	👍👍👍		
Perchloroethylene (tetrachloret.)	👍👍👍	👍👍		👍👍👍	N	👍👍	👍👍👍		N
Permanganate de potassium	👍👍	👍👍		👍👍	👍👍👍	N	👍👍👍		
Hydrogen peroxide	N	👍👍👍	N	👍👍		N	👍👍		
Chlorohated Peroxyde						N	👍👍👍		
Phenol	N	N			👍👍👍	N	👍👍👍		
Ammonium phosphate			👍👍👍	👍👍👍	👍👍👍	👍👍👍	👍👍👍		
Trisodium phosphate	👍👍👍	N		👍👍👍	👍👍👍	👍👍👍	👍👍👍		
Aluminium polychlorite						👍👍👍	👍👍👍		
Polyelectrolytes						👍👍👍	👍👍👍		
Caustic potash		N		👍👍👍		N	👍👍👍		
Sodium silicate					👍👍👍	👍👍👍	👍👍👍		
Soda						N	N		
Aluminium sulfate					👍👍👍	👍👍👍	👍👍👍	👍👍👍	N
Ammonium sulfate					👍👍👍				👍👍👍
Calcium sulfate	👍👍👍	👍👍👍		👍👍👍	👍👍👍		👍👍👍		
Copper sulfate				👍👍👍	👍👍👍	👍👍👍	👍👍👍		👍👍👍
Ferrous sulfate		N		👍👍	👍👍👍	👍👍👍	👍👍👍		
Ferric sulfate	N	N		N	👍👍👍	👍👍👍	👍👍👍		👍👍👍
Sodium sulfate	N				👍👍👍	👍👍👍	👍👍👍		
Hydrogen sulfur	👍👍👍				👍👍👍	👍👍👍	N		
Carbon tetrachloride	👍👍		👍👍👍	👍👍👍	👍👍👍	N	👍👍👍		
Toluene	👍👍👍	👍👍👍		👍👍👍	N	N	👍👍👍		N
Trichlorethane	👍👍	N		👍👍	N	N	👍👍👍		N
Trichlorethylene	👍👍	👍👍👍		👍👍	N	N			N
Triethyleneglycol				👍👍	👍👍👍		👍👍👍		
Urea	👍👍	👍👍		👍👍	👍👍👍		👍👍👍		
Xylenes	👍👍	👍👍		👍👍	👍👍👍	N	👍👍👍		N

👍👍👍 = High Compatibility
 👍👍 = Good Compatibility

👍 = Low Compatibility
 N = Not Compatible

Bond | Protect | Beautify

With our manual guns, automatic and robotic applicators, supplied by our wide range of pumps & machines for fluid handling, dosing, mixing & dispensing.

SAMES KREMLIN provides industrial solutions for production increase, quality improvement, material & cost savings.

We are designers and manufacturers of process equipment that is divided into 6 ranges:

Airspray: Since 1925, we have been an Airspray manufacturer bringing you the very best in finishing.

Airmix®: Creator of Airmix® Technology since 1975, we provide the perfect mix between quality and productivity.

Airless: We provide premium Airless Products for finishers with demanding applications.

REXSON Dispense: Pumping beyond possible, dispensing precisely.

Electrostatic liquid: expertise for high finishing quality & efficiency.

Powder: Powder coating solutions for the highest Productivity since 1960.

FIND YOUR
LOCAL CONTACT
BY FLASHCODE:



www.sames-kremlin.com

SAMES  **KREMLIN**